

ELECTRONICS
AND
ELECTRON TUBES

BY

E. D. McARTHUR

Vacuum Tube Engineering Department
General Electric Company

NEW YORK
JOHN WILEY & SONS, Inc.
LONDON: CHAPMAN & HALL, LIMITED
1936

COPYRIGHT, 1936,
BY ELMER D. MCARTHUR

All Rights Reserved

*This book or any part thereof must not
be reproduced in any form without
the written permission of the publisher.*

Printed in U. S. A.

Printing
F. H. GILSON CO.
BOSTON

Composition
TECHNICAL COMPOSITION CO.
BOSTON

6-38
Binding
STANHOPE BINDERY
BOSTON

TO
D. K. McA.

PREFACE

In the last few years, electron tubes have been finding a rapidly expanding field of application in many kinds of industry. They are "radio tubes" no longer; instead, they are recognized as extremely versatile devices which are supplying solutions to many difficult problems.

The growing interest in all kinds of electron tubes and their applications has created a demand for information about every phase of the art. The author has tried to meet a part of this demand by describing, in this book, the fundamental principles which govern the action of all electron tubes.

Mathematics is used sparingly and confined to the statement of a formula where it is used. Various applications are described or suggested to illustrate the fundamental principles involved. Gas-discharge tubes are allotted more space than usual because of their growing importance.

The bibliography is designed to permit the reader to extend his knowledge of any particular phase of the electron-tube art. For further material, he should consult the extensive bibliography published in *Electrical Engineering* for January, 1935, by J. W. Horton or a shorter one by the present author which appeared in the *General Electric Review* for July, 1935.

A large amount of the material in this book has been published previously in serial form under the same title in the *General Electric Review*. The author wishes to express his thanks for permission to reproduce this in the present book. He also wishes to express his thanks to the General Electric Company for all the photographs and most of the

curves which have been used. The table of values of β^2 which appears in the Appendix is reproduced through the courtesy of the editors of *Physical Review*. Material taken from other sources is acknowledged in the text.

E. D. McARTHUR

SCHENECTADY, N. Y.

June, 1936

CONTENTS

CHAPTER	PAGE
I. ELECTRONS, ATOMS, MOLECULES	
1. Electrons	1
2. Atoms	2
3. Molecules	3
4. Electrons and electricity	4
Bibliography	7
II. PROPERTIES OF GASES	
5. Velocity	8
6. Density	9
7. Pressure	10
8. Mean free path	10
9. Random current density	12
10. Evaporation	13
11. Ionization and excitation	13
Bibliography	17
III. ELEMENTS OF ELECTRON TUBES	
12. Components of electron tubes	19
13. Fundamental phenomena	23
14. Electron emission	25
15. Cathode requirements	28
16. Pure tungsten cathode	29
17. Thoriated-tungsten cathodes	31
18. Coated cathodes	33
19. Schottky effect	36
20. Field emission	37
21. Secondary emission	38
22. Photoemission	38
23. Space charge	41
Bibliography	49
IV. TWO-ELECTRODE TUBES	
24. High-vacuum phototubes	50
25. Gas-filled phototubes	53
26. Selenium tubes	55
27. Two-electrode thermionic tubes	56
Bibliography	58
V. CONTROL OF ELECTRON CURRENTS	
28. Single-grid tubes	59
29. Double-grid tubes	68
30. Triple-grid tubes	73
31. Internal-grid tubes	74
32. Magnetic control	76
Bibliography	79

CHAPTER	PAGE
VI. TRIODE AND MULTI-GRID-TUBE APPLICATIONS	
33. Dynamic characteristics	80
34. Amplifiers	86
35. Class A amplifiers	89
36. Class B amplifiers	91
37. Class C amplifiers	92
Bibliography	99
VII. GAS- OR VAPOR-FILLED TUBES	
38. Comparisons with high-vacuum tubes	100
39. Formation of the arc	101
40. The plasma	107
41. Sheaths	111
42. Two-electrode tubes	117
43. Three-electrode tubes	120
44. Magnetic control	128
45. Grid current	130
46. Shield-grid tubes	132
47. Pool tubes	135
Bibliography	139
VIII. APPLICATION OF GAS-FILLED TUBES	
48. Principles of control	141
Bibliography	152
IX. SPECIAL TUBES	
49. Cathode-ray oscillograph tube	154
50. Vacuum switches	156
51. Barkhausen-Kurtz oscillator	157
52. High-voltage rectifier tube	158
Bibliography	159
X. CONSTRUCTION OF ELECTRON TUBES	
53. The tube envelope	161
54. Cathodes	164
55. Anodes	164
56. Grids	167
57. Exhaust	167
APPENDIX	168
INDEX	169

ELECTRONICS AND ELECTRON TUBES

CHAPTER I

ELECTRONS, ATOMS, MOLECULES

1. Electrons.⁶ The performance of the various devices which are to be described is made possible by the characteristics of electrons, atoms, and molecules. Unlike objects which can be perceived directly with one of the five senses, the electron is of such a nature that knowledge of it can be secured only by translating its effects into other effects which are perceivable by sight or sound. For example, a study can be made of the flow of electrical charges through a wire by observing the magnetic effect or heating effect of the current, but the individual charges cannot be examined.

Early studies of the effects produced by electrons enabled physicists to form a more or less accurate picture of the electron. These studies suggested the conception of an electron which will be used throughout the book. This conception pictures an electron as an extremely minute particle having a definite mass and carrying a definite negative charge of electricity. This charge is 1.591×10^{-19} coulomb or 4.774×10^{-10} electrostatic unit. Various investigators have been able to measure the ratio of the charge to the mass of an electron. From these data, the mass of the electron is found to be 9.01×10^{-28} gram.

Other researches¹ in the field of electronic and atomic theories have extended this picture, but a visualization of this enlarged conception is not essential to a working knowledge of the operation of electron tubes.

2. Atoms.^{2,3} The concept of an atom which pictures it to be a small, hard, elastic sphere led to the assumption

that its properties could be described by the same physical laws that describe the flight of a bullet or any other large-scale mechanical phenomenon. It was found, however, that not all predictions based on these laws agreed with experiment — in particular, these theories would not explain radiant energy.

The following theory of atomic structure was formulated by Bohr to account for the radiation of light from the atoms of the various elements when these atoms give up energy previously supplied them. This radiation of light of a characteristic color is exemplified by the reddish light from a neon sign or the bluish-white light from a mercury-vapor lamp.

An atom is represented as a system which comprises a very dense core, called the nucleus, about which the electrons revolve. The whole structure is somewhat like a miniature solar system in which the sun represents the central core, and the planets represent the electrons. Each atom has, in its normal state, a certain number of electrons which rotate about the nucleus in definite orbits. These electrons contribute a negative charge to the atom which is offset by an equal positive charge residing in the nucleus. As a result, the normal atom exhibits no preponderance of either charge and is electrically neutral.

The negatively charged electrons and the positively charged nucleus exert a mutual attractive force which tends to make the system collapse. This force is exactly balanced by the centrifugal force exerted on the rapidly revolving electron.

Bohr suggested that an electron could not follow any orbit about the nucleus but only those orbits in which the electron would have certain values of angular momentum. Suppose that the angular momentum of an electron rotating in the first orbit be taken as a unit — the theory restricts the possible additional orbits to those in which an electron would have a whole number of units of angular momentum. For example, an electron in the second orbit

would have twice the angular momentum of an electron in the first orbit. Similarly, in the third orbit the momentum would be three units. No intermediate orbits are possible. Thus, the orbits may be named by a series of whole numbers (1, 2, 3, etc.) which measure the angular momentum associated with a particular orbit. The electrons moving in orbits near the nucleus have large forces acting on them; and, conversely, the electrons in the outer orbits have smaller forces acting on them. The amount of energy possessed by an electron revolving in any of these orbits is characteristic of the orbit. Consequently, electrons may be considered to revolve about the nucleus in different energy levels.

An electron must be capable of absorbing or giving up energy to move from one level to another. The reception of energy by an electron results in its moving to an outer orbit, while energy release is accomplished when an electron moves to an inner orbit. The amount of energy received or released by an electron is clearly the difference between its energy in the orbit which it leaves and its energy in the orbit which it reaches. Energy loss is usually accomplished by radiation.

The frequency of the radiated energy is given by an equation due to Planck:

$$E = hf$$

where

E is the amount of energy radiated (ergs).

f is the frequency of the radiation (cycles per second).

h is Planck's constant = 6.55×10^{-27} erg-second.

The usefulness of this theory will become evident in the discussion of photoelectricity.

It is possible to remove electrons entirely from an atom by giving them the required amount of energy. This energy may come from incident radiation, such as ultra-violet light, X-rays, etc., or from a collision with a fast-moving particle, such as another electron or atom. An atom which has lost

one or more electrons is called a positive ion, and the process resulting in the loss is called ionization.

Each chemical element is made up of these atoms. The main and, perhaps, the only difference between the various elements is the structure of the nucleus and the number of positive charges carried by it. This results in a different number of electrons for the atoms of each element. For example, the atom of hydrogen has but one electron, whereas the atom of uranium has 92 electrons.

This simple theory is being constantly elaborated by the discovery of new principles and the invention of new methods of analysis. However, an intimate knowledge of these new methods is not essential to an understanding of electronic devices.

The mechanical model of the atom which has been described is probably the most convenient picture to use for our purpose. At the same time, it must be realized that this model is a purely mechanical description which has been developed for convenience in forming mental pictures. It is used here because in the majority of cases the atom acts as if it were, in reality, a simple mechanical system of rotating particles such as has been described.

3. Molecules. Atoms, in turn, combine with each other to form a more complex structure called the molecule. In some cases, atoms of the same element combine to form a molecule of that element. In others, atoms of different elements may combine to form a molecule of a new substance. An example of the first case is the hydrogen molecule, which is made up of two hydrogen atoms. The second may be illustrated by the sodium chloride molecule which is a combination of an atom of chlorine and an atom of sodium. All matter is made up of these atoms and molecules or combinations of them.

4. Electrons and Electricity. In their normal state, the motion of atoms and molecules is unaffected by an electric or magnetic field. A positively or negatively charged particle is, however, influenced by such fields. For example,

an electron will be attracted by a positive charge or a positively charged electrode, and a positive ion will be attracted by a negative charge. The speed given to a charged particle by an attracting electrode may be found from the following relation:

$$C = 0.081 \sqrt{\frac{Ve}{m}}$$

where

e is charge in electrostatic units.

C is the speed in centimeters per second.

* m is the mass in grams.

V is the potential difference between the ends of the path followed by the particle.

Early experiments demonstrated that a cathode ray (now known to be a stream of electrons) could be deflected from its path by a magnetic field. Further experiments along these lines convinced J. J. Thomson that the cathode ray was made up of small, negatively charged particles which were given the name electrons. These experiments demonstrated that a moving, charged particle acts like an electric current in a wire. This fact suggested that the conduction of electricity through metals might be explainable on the basis of an electron theory.⁴ The work which has been done on this subject has led to the theory that the conduction of electricity through a metal is a result of the presence of enormous numbers of free electrons in the metals. Furthermore, the small number of these free electrons in some other materials results in their being poor conductors or insulators.

Free electrons are those which have been partially removed from the immediate influence of their atomic nucleus. These free electrons are distributed throughout the interatomic space and form a sort of electron gas. So long as no external force is applied, the direction and velocity of motion of these electrons are random. If an electromotive

* The mass of a particle having an atomic weight of 1 is 1.64×10^{-24} gram.

force be applied to the metal, the direction of motion will no longer be completely random for the electron will be given a drift velocity in the direction of the positive terminal. This flow of electrons constitutes the electric current.

An idea of the number of electrons engaged in the conduction of a current of electricity may be gained from a simple calculation. One ampere is defined as the flow of one coulomb of electricity per second past any point in a conductor. Since the charge carried by an electron is 1.591×10^{-19} coulomb, a flow of one ampere requires that 6.3×10^{18} electrons move past any point in a conductor every second. Although the drift velocity of the electrons carrying the charges is comparatively low, the electrical impulse will be transmitted along the conductor with the speed of light; 3×10^8 meters per second or 186,000 miles per second. This is because all the electrons in the conductor begin to move as soon as the electric field is established throughout the conductor, and it is not necessary, therefore, to move any one electron along the entire path to establish the current. An analogy is afforded by a pipe full of water. Flow of water through the pipe commences as soon as pressure is established throughout the pipe, although it may take some considerable time for water at the entrance end of the pipe to reach the exit.

The relation between the electromotive force or pressure and the current of electricity through a conductor has been found experimentally and is known as Ohm's law. This law states that the current is directly proportional to the electromotive force and inversely proportional to the resistance of the conductor. The resistance of the conductor is the impediment offered by the atomic structure of the material to the flow of electrons. Changing the electric field in the conductor changes the speed of the electrons. Since the value of the electric current depends on the electron speed, changing the electric field (which is directly proportional to the electromotive force) will change the electric current proportionately.

Current in an electrical network is said to flow from the positive to the negative terminal. However, if the current flow is considered to be a drift of electrons, it is found that the electrons flow from the negative to the positive terminal, contrary to the accepted direction. The reason for this contradiction is that the accepted direction of current flow is merely an arbitrary convention adopted many years before the electron was discovered.

This theory of current conduction in metals has met with some reverses in the last few years.⁵ The difficulty is not with our concept that an electric current consists of moving free electrons but rather with our lack of detailed knowledge of the exact state of the electrons in a metal.

Many physicists are working on the problem from modern physical viewpoints and have already succeeded in clearing up some of the outstanding discrepancies.

BIBLIOGRAPHY

1. Modern Concepts in Physics and Their Relation to Chemistry (President's Address), IRVING LANGMUIR, *Journal American Chemical Society*, October, 1929.
2. Modern Physics, A Survey, SAUL DUSHMAN, *General Electric Review*, June and July, 1930.
3. Quantum Theory, SAUL DUSHMAN, *Journal of Chemical Education*, June, 1931.
4. Conduction of Electricity through Metals, J. J. THOMSON, *Proceedings of the Physical Society*, 1914-1915.
5. The Present Theory of Electric Conduction, K. F. HERZFELD, *Electrical Engineering*, April, 1934.
6. Fundamental Properties of the Electron, A. WATERMAN, *Electrical Engineering*, January, 1934.

CHAPTER II

PROPERTIES OF GASES

5. Velocity. Any study of electronic devices is intimately connected with the nature and properties of gases as well as electrons. It is necessary, therefore, to examine these properties more closely.

It has been found that most of the properties of a gas can be described quantitatively by assuming that the gas molecules or atoms are highly elastic spheres which obey Newton's laws of motions. The kinetic theory^{1,4} of gases describes the properties of the gas by deriving statistical laws which give the average performance of the particles.

A gas consists of a vast number of molecules or atoms moving in random directions with a wide range of velocities. The velocity distribution is given by a mathematical relation first determined by J. C. Maxwell. This distribution law² has been derived in a number of ways but was originally determined by applying the laws of probability. By this method, Maxwell was able to calculate the average number of particles which would have velocities lying between any value c , and $c + dc$, where dc is a small increment of velocity.

The fraction of the total number of particles having velocities lying in any such band does not change with time even though the individual velocities are changed abruptly as the result of the numerous collisions.

The velocities may be averaged in several ways for different purposes, but the one most often used is the so-called root-mean-square velocity. The average kinetic energy of a single particle is $3/2KT$ ergs, and the root-mean-square velocity is defined as that velocity which, according to the

usual mechanical laws, gives the particle an energy of $3/2KT$ ergs. From this definition, we find that the average velocity is given by:

$$\text{Average velocity} = \sqrt{\frac{3KT}{m}} \text{ cm per sec}$$

where

K is the Boltzmann constant = 1.37×10^{-16} ergs per degree K.

T is the absolute temperature = $T^{\circ}\text{C} + 273 = T^{\circ}\text{K}$.

m is the mass of the particle in grams.

Illustrative values of this velocity are given in Table I.

TABLE I

Gas Particle	$T^{\circ}\text{C}$	RMS Velocity, meters per second
H ₂	25	1920
He	25	1362
N ₂	25	515
A	25	433
Hg	25	192

6. Density. Closely associated with the velocity distribution is the density distribution. Even though the gas particles are moving with apparently erratic motions, the concept of density can be associated with the gas.

It can be defined as the number of particles whose centers are contained in a unit volume at any instant. If there is no field of force acting on the gas, the particle density will be constant throughout the whole volume.

If there is a field of force acting on a gas which is otherwise in equilibrium, the density distribution is given by an equation due to Boltzmann:

$$N_a = N_b e^{(w/\kappa T)}$$

where

N_a is the density at point a .

N_b is the density at point b .

w is the work necessary to move the particle through the distance $a-b$ against the force field.

For example, suppose that we have a cylindrical container 5 inches deep filled with mercury vapor at a temperature of 300° K or 27° C and that by some means the acceleration due to gravity could be increased 1000 fold. Boltzmann's equation tells us that, then, the density at the bottom of the container would be about 10 per cent greater than the density at the top.

7. Pressure. The gas pressure is simply the force exerted on the walls of the gas container by the atomic or molecular impacts. The gas pressure is related to the density by the equation:

$$P = N_0KT$$

where

P is the pressure in baryes (dynes per square centimeter).

N_0 is the number of gas particles per cubic centimeter.

The gas pressure may be increased either by heating the gas which makes the particles move faster and hit harder, or by pumping more particles into the container.

8. Mean free path. The particles are constantly colliding with one another and, therefore, can move only a definite average distance between collisions. This average distance is known as the mean free path.

It depends on the size of the atoms or molecules, upon the number contained in a unit volume, and upon the particle speed. The types of collisions which occur between these particles are difficult to describe without more detailed knowledge of their shapes. If they are spherical, however,

the average distance between collisions of unlike particles is given by the relation:

$$\lambda_{ab} = \frac{1}{N_b \sigma_{ab}^2 \pi \sqrt{1 + \frac{C_b^2}{C_a^2}}}$$

where

λ_{ab} is the average distance in centimeters between collisions, or the mean free path of a particle of type a .

N_b is the density of particles of type b with which type a is colliding.

C_a and C_b are the speeds of the two particles.

σ_{ab} is the average diameter of the two colliding particles and is given by:

$$\sigma_{ab} = \frac{\sigma_a + \sigma_b}{2}$$

where

σ_a and σ_b are the diameters of the two particles a and b , respectively.

This is a general relation for the mean free path which reduces to a much simpler form if the particles a and b are of the same kind. In this case, the relation becomes

$$\lambda_m = \frac{1}{N \pi \sigma_m^2 \sqrt{2}}.$$

If the colliding particle is an electron, its contribution to the collision radius σ_{ab} may be neglected. Furthermore, the electron speed will usually be so much higher than the molecular speed that the molecular speed may be considered zero. For this special case, the relation for mean free path reduces to:

$$\lambda_e = \frac{4}{N_m \pi \sigma_m^2}.$$

Comparing this with the mean free path of the molecule gives:

$$\lambda_e = 4 \sqrt{2} \lambda_m = 5.66 \lambda_m.$$

This kinetic-theory value of the electron mean free path is valid only in so far as a swarm of electrons behaves like an ideal gas and when the electron speeds are high enough to permit the preceding simplification. The conception is useful in a discussion of gaseous discharges, however, because, in most cases, the electrons do behave like a gas with a very high temperature.

Table II gives some values of the electron mean free path calculated with the aid of this relation from experimental determinations of the molecular mean free path.

TABLE II

Gas	Pressure (microns)*	Temperature, °C	λ_m (cm)	λ_e (cm)
He	1.0	25	22.2	125.8
H ₂	1.0	25	14.4	81.5
Ne	1.0	25	13.9	78.6
A	1.0	25	7.95	45.0
N ₂	1.0	25	7.50	42.4
CO	1.0	25	7.45	42.1
CO ₂	1.0	25	5.0	28.3
Hg	1.0	25	2.65	15.0

* 1 micron = 10^{-3} mm of Hg = 1.33 baryes.

9. Random current density. The number of particles moving across a square centimeter from either direction in a gas is known as the random current density.

Numerical values of this density can be found from the following relation:

$$\text{R.C.D.} = \frac{p}{\sqrt{2\pi mKT}} \text{ particles per sq. cm. per second}$$

where m is the mass of the particle in grams and the other terms of the equation have the same meaning as in the preceding equations. Some typical values of the random current density are given in Table III.

TABLE III

Gas	Pressure (microns)	Temperature, °C	R.C.D.
H ₂	0.75	25	1083 × 10 ¹⁵
He	0.75	25	769 × 10 ¹⁵
N ₂	0.75	25	290 × 10 ¹⁵
CO	0.75	25	290 × 10 ¹⁵
O ₂	0.75	25	272 × 10 ¹⁵
A	0.75	25	244 × 10 ¹⁵
CO ₂	0.75	25	232 × 10 ¹⁵
Hg	0.75	25	108 × 10 ¹⁵

10. Evaporation. In a liquid the atoms are more restricted in their motions because they are more closely spaced, and in a solid body the spacings are even smaller and the restriction on motion even greater. It might be supposed that, since the atoms or molecules are moving at such high speeds in all directions, some of them might occasionally jump away from the surface of the material. Over a body of water, for example, molecules are in continuous motion both in and out of the surface. Loss of the molecules in the cloud over the surface gives rise to the familiar phenomenon called evaporation. The same phenomenon occurs in metals at high temperatures and results in loss of the material, just as with water when it evaporates. As will be shown later, this process is very important in the life of an electron tube.

11. Ionization and excitation.^{3, 5, 6, 7, 8} An atom or molecule is said to be excited when one or more of the component electrons has been raised to an energy level above normal. Excitation, therefore, always requires an addition of energy.

Usually, the energy added during excitation is ejected as light after about 10⁻⁸ second. However, there are certain energy levels in the atom which an electron cannot reach and from which an electron cannot return by absorbing or emitting radiant energy. An atom which has had an electron raised to such a level is said to be in a metastable state.

Excitation of an atom may be caused by impact with a high-speed electron, ion, or atom, or by the absorption of radiant energy.

Ionization is any process which enables a normal atom or molecule to acquire an electrical charge. Negative ions, which are the result of the acquisition of an electron by an atom, are relatively unimportant in electron tubes. Positive ions formed by driving one or more electrons completely out of the atom are extremely important. For this reason, the term ionization has come to mean the formation of positive ions.

Ionization requires the addition of a definite minimum amount of energy which is characteristic of the atom. The amount of energy required for ionization or excitation is usually not expressed in energy units but rather in terms of the voltage required to give an electron sufficient speed to cause the transition. It is for this reason that we speak of ionization or excitation potentials instead of energy.

Table IV gives some values of the critical potentials corresponding to ionization and metastability.

TABLE IV

Gas	Critical Potential (volts)	
	Ionization	Metastability
Helium.....He	24.48	19.73
Neon.....Ne	21.47	16.65
Argon.....A	15.69	11.57
Nitrogen.....N ₂	16.00	
Mercury.....Hg	10.39	4.68

Ionization is an unstable atomic state and the ions tend to return to neutral atoms by recombination with an electron in space or at the surface of a collecting electrode.

Positive ions are formed in many ways. Thermal ionization is of major importance in high-pressure arc discharges

but of little importance in the types of discharge tubes to be discussed later although there is some evidence to indicate that thermal ionization may be important in discharges having a current density greater than 50 amperes per square inch.

Ionization may occur when a high-speed atom, electron, or ion hits a normal or an excited atom and knocks one or more electrons completely out of it. Little is known about ionization by atomic impact and but very little more about ionization by collision with high-speed ions. Ionization by electron impact is rather well known and is recognized as the most important in low-pressure gas discharges.

Let us, therefore, observe what happens if a beam of electrons be shot into a gas. If the electrons have a slow speed—less than the first critical potential—nothing happens except an insignificant transfer of kinetic energy to the whole atom. If the electron speed be increased, nothing happens until the first critical potential is reached, and then some of the collisions will result in excitation to a higher level. If this critical level is a metastable state, the energy will be trapped until lost by transfer or until the atom is excited to a higher state or ionized. Further increases in electron speed reach the higher excitation levels and finally the ionization level. There are, in general, two types of collision: elastic impacts, at which practically no energy transfer occurs; and inelastic impacts, which transfer enough energy to cause excitation or ionization.

Ionization may arise through impacts with electrons of less than ionizing potential by a multi-stage or cumulative process which consists of excitation at one or more collisions and finally ionization at another collision.

The length of time which an atom will persist in a metastable state is very much longer than for the other excited states. Accordingly, the possibility of ionization of metastable atoms is rather high.

It should be noted that, in any process which forms positive ions, the products are a positive ion and another free

electron. This new electron may acquire energy from an electric field and continue on to form more ions.

Not every electron impact results in ionization even though the electron has the required energy. The ionizing power of electrons at any velocity is usually expressed by a number, known as the ionization probability, which is equal to the number of ions which will be formed in one centimeter of the electron path.

The probability of ejecting more than one electron is small, but the effect does occur, particularly at velocities well above the ionizing potential. These multiple-charged ions, however, frequently steal an electron from a neutral atom and so produce two or more singly charged ions.

In gas discharges, we are concerned primarily with the

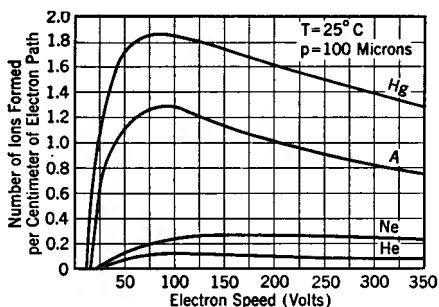

From data by P. T. Smith, *Physical Review*, Oct., 1930 and Apr., 1931.

FIG. 1. The average number of positive ions formed by one electron for various accelerating voltages.

total production of positive charges, and, therefore, the extent to which multiple ionization occurs is relatively unimportant.

The probability of ionization by electron collision rises rapidly from the ionization potential to a maximum value at 100 to 300 volts, depending on the gas, and then falls slowly for higher voltages. The curves of Fig. 1

illustrate the ionization probability for several gases.

Fig. 2 shows the probability of ionization at a single impact. The curves for Fig. 2 were calculated from Fig. 1 and the values of the electron mean free path given in Table II.

At the pressures ordinarily used in gaseous-discharge tubes, the ionization per centimeter path is directly proportional to pressure.

The probability of ionization by positive-ion collision is

not well known quantitatively, although it is known that the probability is low for ions of less than several hundred volts velocity.

For our purposes, we may consider that a gas consists of an enormous number of small, highly elastic spheres mov-

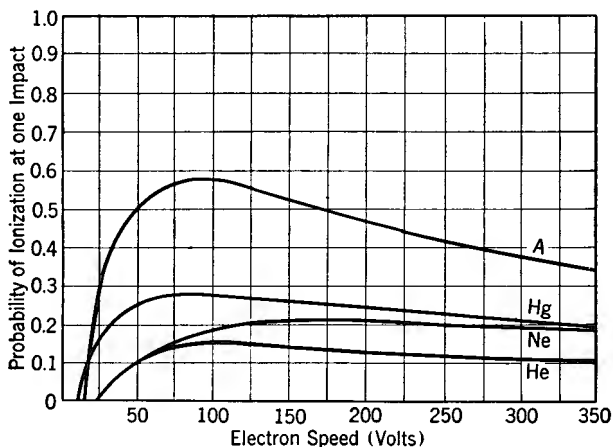

FIG. 2. Curves calculated from Fig. 1 and Table II which show the probability of ionization at a single collision.

ing at high speed in perfectly random directions. The motion of the particles is characterized by an average velocity such that each particle has an average kinetic energy of $3/2KT$ ergs and by an average distance between collisions called the mean free path.

The individual particles are subject to excitation or ionization in several ways, of which the most important in gas-discharge tubes is ionization by electron impact.

BIBLIOGRAPHY

1. The Dynamical Theory of Gases, J. H. JEANS, Cambridge University Press.
2. Statistical Mechanics, R. C. TOLMAN, The Chemical Catalog Company.
3. Electrical Discharges in Gases, K. T. COMPTON and IRVING LANGMUIR, Part I, Review of Modern Physics, April, 1930.
4. Kinetic Theory of Gases, L. B. LOEB, McGraw-Hill Book Company.

5. Ionization of Mercury Vapor by Electron Impact, P. T. SMITH, *Physical Review*, April, 1931.

6. Ionization of Neon, Helium and Argon, P. T. SMITH, *Physical Review*, 1930.

7. Ionization and Excitation, LEWIS TONKS, *Electrical Engineering*, February, 1934.

8. Fundamental Electrical Properties of Mercury Vapor and Monatomic Gases, A. W. HULL, *Electrical Engineering*, November, 1934.

CHAPTER III

ELEMENTS OF ELECTRON TUBES

12. The components of electron tubes. The term electron tube means a device consisting of an envelope which is evacuated to any extent or which contains gas or vapor under any degree of pressure, and which contains two or more electrodes capable of controlling the flow of energy supplied to them. There are two main classes of such devices: the first includes all tubes in which the current flow takes place in a highly evacuated chamber; the second class comprises the tubes in which current flow occurs in a chamber containing some kind of gas or vapor at a pressure considerably higher than that in the tubes of the first class. Both types of tubes use the same fundamental components; that is, each has an element which serves as a source of electrons and another element which is the receiver of the electrons. In addition,

some of the tubes of both classes have one or more additional elements called control electrodes, since they serve

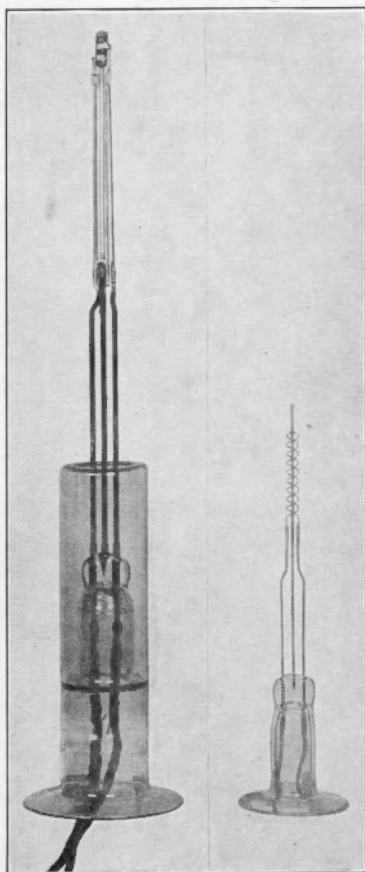

FIG. 3. Typical cathode mounts; pure tungsten filament on the left and a thoriated-tungsten filament on the right.

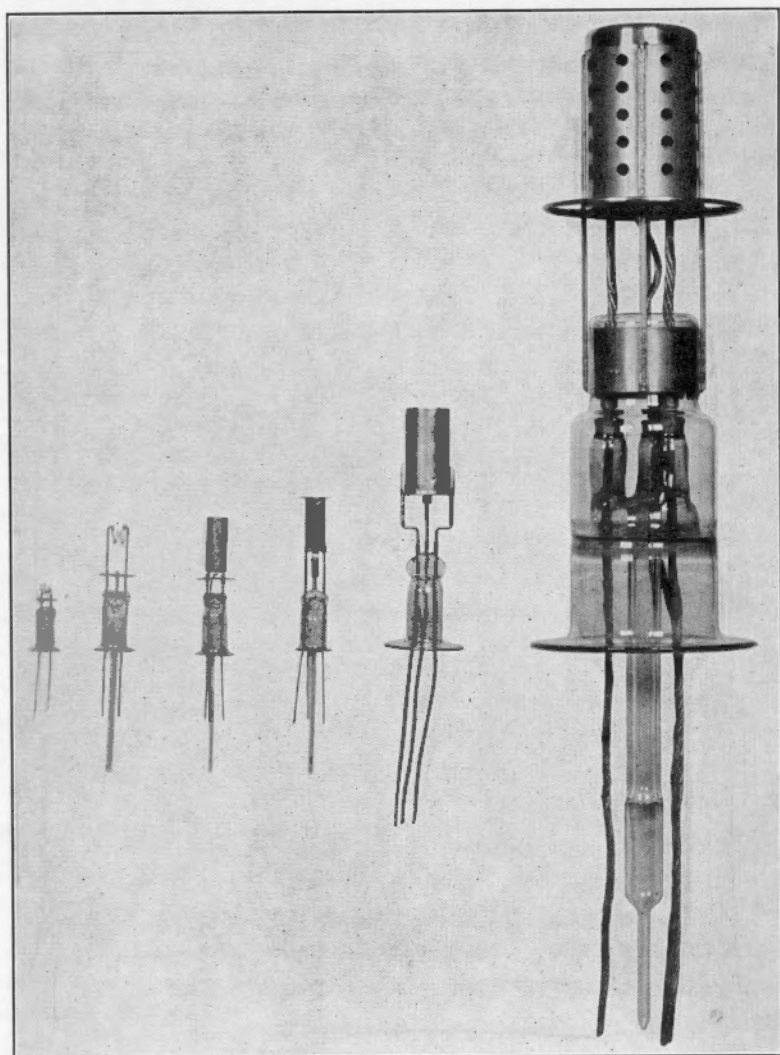

FIG. 4. A group of barium-coated cathodes. The two at the left are coated filaments. The others are indirectly heated, heat-shielded cathodes. The small filament can supply about 2.0 amperes of electron emission. The cathode at the extreme right can supply an electron emission of about 600 amperes.

to regulate the flow of electron current. In every case, these electrodes are mounted in a closed chamber of glass or metal. The fundamental difference, then, between these two classes of tubes is that, in the first class, the gas is pumped out until a pressure of about 10^{-3} micron is reached;

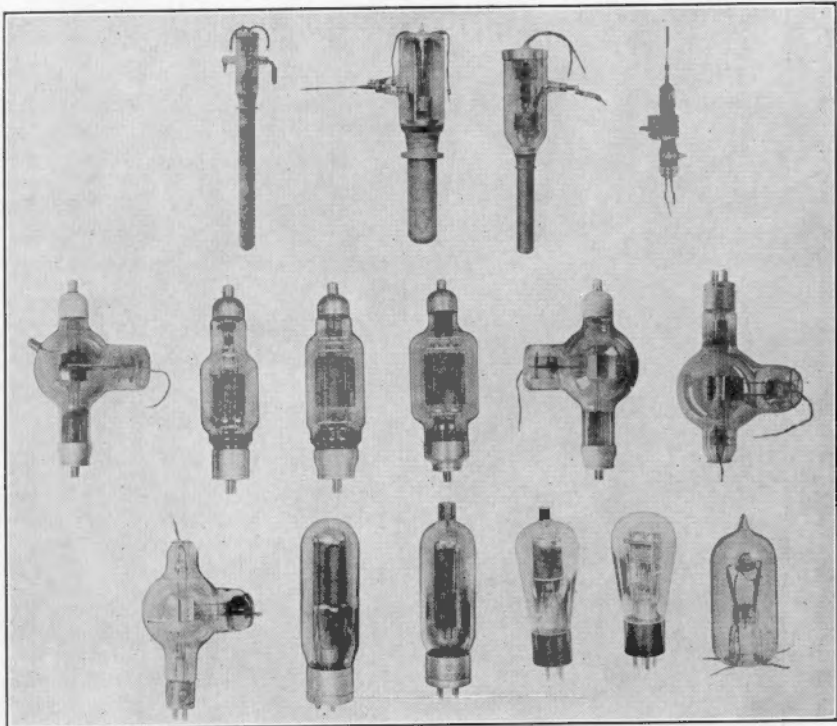

FIG. 5. A few of the many types of high-vacuum tubes. The top row shows some of the high-voltage, water-cooled tubes. The other rows show lower voltage, air-cooled tubes.

while in the second class, a pure gas or vapor is admitted, after the tube has been pumped out, to give a pressure ranging from 1 up to 500 microns. The first class comprises the so-called high vacuum tubes; the second, all the gas-filled or vapor-filled tubes.

According to the terminology common in practice, the element serving as the source of electrons is called the

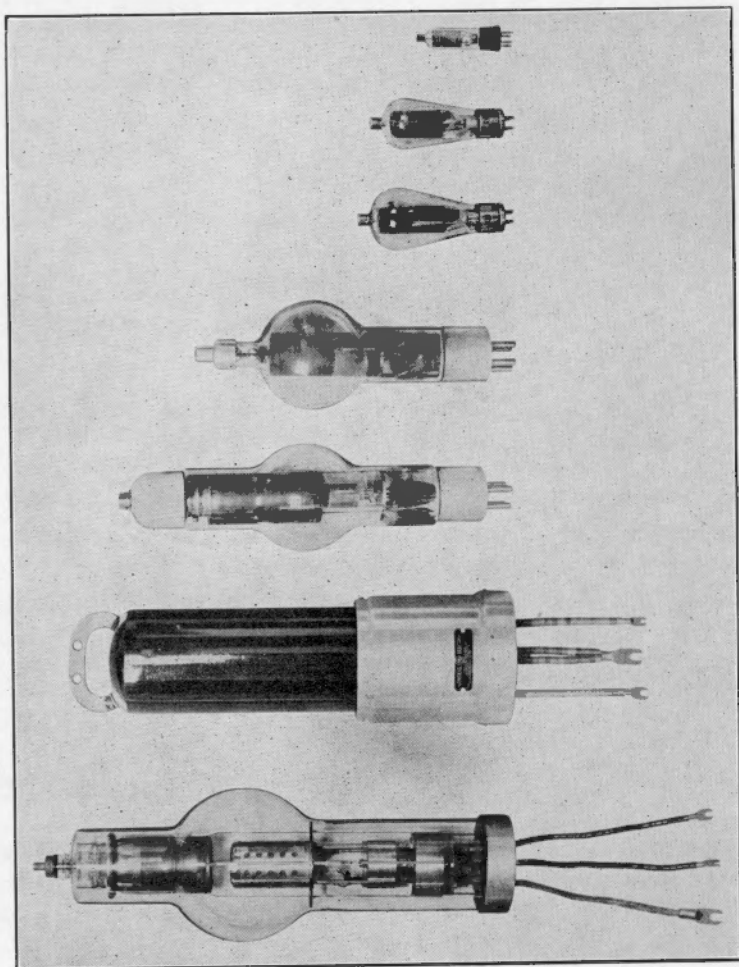

FIG. 6. A group of three-electrode, mercury-vapor-filled tubes. The ratings of these tubes range from 15,000 volts and 75 amperes down to 1,000 volts and 0.125 ampere.

cathode, and the electron-receiving element is known as the anode. Any electrode, other than the cathode or anode, which in any way serves to influence the electron current, is known as a control electrode.

Figs. 3 and 4 illustrate some of the many types of cathodes which are used in electron tubes, and Figs. 5 and 6 show a few of the many types of tubes.

13. Fundamental Phenomena. The whole family of electron tubes grew from the discovery that an electric current will flow between an incandescent filament and a positively charged plate in a vacuum.

One of the earliest observations of this effect was made by Edison and called the Edison effect. Edison found, while experimenting with incandescent lamps, that, if he put a small metal plate in the lamp and connected this plate through a meter to the positive terminal of the lamp filament — which was operated from a direct-current source — the meter indicated the passage of a small electric current. Furthermore, if the plate were connected to the negative filament terminal, there would be no current flow.

Edison offered no explanation of this effect, and there the matter rested until Fleming recognized the rectifying properties of such a device.

Today, we know that what Edison observed, when he connected his plate to the positive filament terminal, was a flow of electrons from the more negative parts of the filament to the plate.

If a similar device be studied experimentally, the following facts will be found. If the plate be held at a constant potential, positive with respect to the filament, no current will flow to the plate when the filament is cold. Furthermore, there will be practically no current flow until the filament has been heated to incandescence. Increasing the temperature will cause larger and larger currents to flow until finally a point will be reached where further temperature increases will cause, at best, a very slight increase in current. If this test be repeated with a different value of plate voltage, the cur-

rent will again rise with filament temperature but will reach a new saturation level. If the values of plate current be plotted against the corresponding values of filament-heating current, a curve such as Fig. 7 will result.

The relation between plate current and plate to cathode voltage may be found by holding the filament temperature

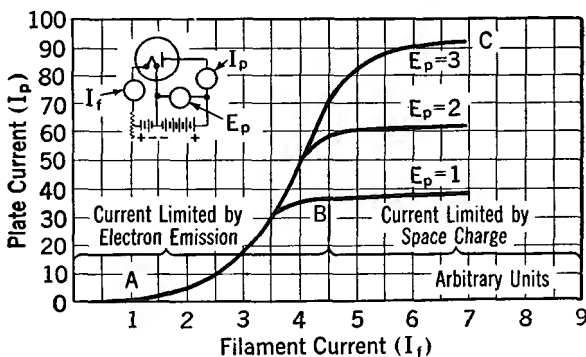

FIG. 7. Typical emission characteristic of a two-electrode, high-vacuum tube.

constant and varying the plate voltage. In this case, the plate current will be zero when the plate potential is zero or negative with respect to the filament. If the plate be made more and more positive, the plate current will rise until, again, a point is reached where further increases in plate voltage will cause very little increase in plate current.

Here also, different values of filament temperature will give different saturation values of current. The experimental data will yield a curve similar to Fig. 8.

The current to the plate is due to a flow of electrons from the filament to the plate. They are liberated from the filament by the thermal energy given them, when the filament is heated, and drawn across the evacuated space by the positive charge on the plate.

Two distinct phenomena cooperate to produce the observed results. In the region *AB* of the upper curve of Fig. 7 the number of electrons which can flow to the plate, and, consequently, the plate current, is limited to the number

liberated at the filament. In the region BC , the current ceases to rise because the plate potential has become insufficient to draw any more electrons away from the neighborhood of the filament. Similarly, in the region LM of Fig. 8, each value of plate current represents the maximum number of electrons which the corresponding plate potential can draw away from the filament. In the region MN , all

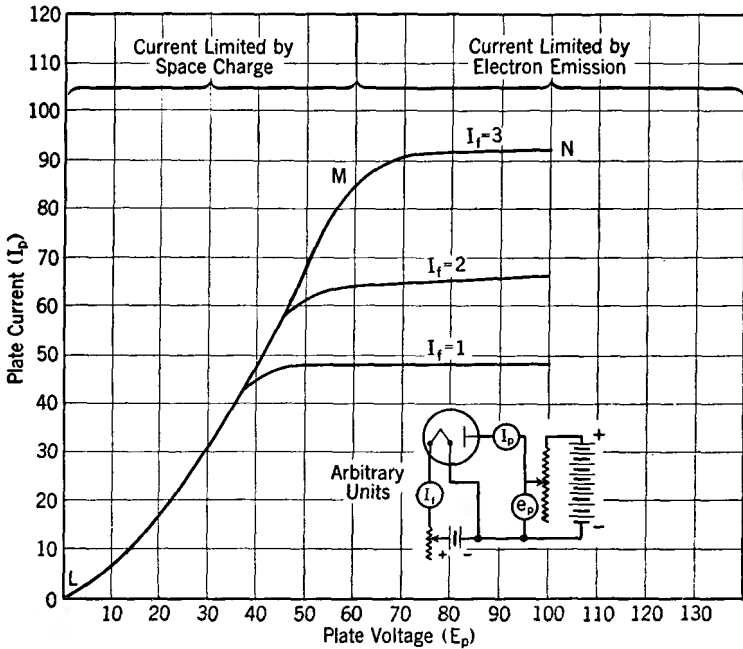

FIG. 8. Volt-ampere characteristic of a high-vacuum, two-electrode tube.

the electrons which are available at the filament are being withdrawn and further increases in current are impossible.

The plate current in section AB of Fig. 7, and section MN of Fig. 8, is said to be emission-limited, while in sections BC and LM the current is said to be space-charge-limited. Since both these effects play some part in every electron tube, they will be considered in greater detail.

14. Electron emission.^{1, 4, 5} The phenomenon of electron emission from a hot metal was described mathematically

by O. W. Richardson by assuming that the free electrons in the metal obey the Maxwell-Boltzmann laws. In addition, he assumed that there exists a boundary force at the surface of the metal which must be overcome before an electron can escape. Because of this boundary force, only those electrons which have an amount of energy in excess of a definite minimum are emitted. However, since the electrons have a Maxwellian velocity distribution, there will always be some which have enough energy to overcome this boundary force. The number which can escape is determined by the temperature. The electric current corresponding to the number of electrons which have the required escape energy is given by Richardson's equation:

$$I = AT^{\frac{1}{2}}\epsilon^{-b/(T)}$$

where

I is the emission current in amperes per square centimeter.

T is the absolute temperature of the cathode.

ϵ is the base of the natural logarithms.

A and b are constants characteristic of the cathode material.

The minimum energy which an electron may have and yet escape through the boundary force is related to the constant b by the equation:

$$\begin{aligned} bK &= e\phi \\ \phi &= 8.62 \times 10^{-5} b \end{aligned}$$

where

ϕ is the voltage through which an electron would have to be accelerated to give it the minimum escape energy.

ϕ is called the work function of the surface since it is a measure of the work which must be done to liberate an electron from the metal.

The existence of a work function is due to the fact that

the escaping electron induces a positive charge in the surface which tends to draw the electron back. The attractive force decreases rapidly as the distance of separation increases, and before long the electron is practically free of the emitting surface. Therefore, before an electron can escape, it must be given sufficient energy to overcome this attractive force. The work required to do this is called the work function of the surface.

There is another factor² which influences the emission of electrons and that is the electric field at the emitting surface due to the anode potential. The anode, since it is charged positively, can and does aid the electrons to escape from the cathode. This apparent decrease of the work function of the surface is called the Schottky effect and will be discussed in greater detail later.

S. Dushman has derived a similar equation on a somewhat different basis. Dushman's equation, which is most generally used, is:

$$I = A_0 T^2 e^{-b_0/(T)}.$$

The terms of this equation have the same significance as in Richardson's equation, but the constants A_0 and b_0 have different numerical values. A_0 is a universal constant which, with a few exceptions, is equal to 60.2 for all pure metals. More modern physical theories require that A_0 should be 120.4 — just twice the earlier value. However, the value given by actual measurement is 60.2 in most cases. The discrepancy between the experimental value and the theoretical value of 120.4 has not been explained. The emission constants³ to be used with Dushman's equation for the more usual pure metals are given in Table V.

The theoretical basis for the emission equations indicates that the emitted electrons should have a Maxwellian velocity distribution. Experiment confirms this prediction and shows that the emitted electrons act like a gas in thermal equilibrium with the cathode. The electrons emitted from a cathode at temperature T have a mean initial velocity

TABLE V

Metal	A_0	b_0	Work Function ϕ_0 (volts)
Platinum (Pt)	17,000	72,500	6.27
Tungsten (W)	60.2	52,400	4.52
Molybdenum (Mo)	60.2	51,500	4.44
Tantalum (Ta)	60.2	47,200	4.07

normal to the cathode given by:

$$V = \frac{T}{11,600} \text{ electron-volts.}^*$$

Because of this initial Maxwellian velocity distribution, a few electrons can flow to an anode which is negatively charged. The amount of current flow may be predicted with the aid of the Boltzmann equation for density distribution.

The rôle played by electron emission in electron tubes is illustrated by the temperature dependence of section AB of Fig. 7 and the saturation levels of Fig. 8.

15. Cathode requirements. The two fundamental qualifications which a suitable thermionic cathode must have are long life and high emission efficiency. By long life, we mean the retention of the original electron emissivity for a long period of time despite such destructive effects as evaporation of the cathode material, chemical poisoning, and mechanical failure.

Emission efficiency is defined as the ratio of maximum electron current to the heat energy required to maintain the cathode at the operating temperature. Emission efficiency is usually expressed in milliamperes per watt.

Thermionic cathodes fall into two broad classes. One of

* It is customary to speak of electron or ion velocity, and sometimes energy, in terms of the voltage required to accelerate the electron or ion to the velocity in question.

these classes comprises all cathodes which supply the emission current directly from a heated pure metal surface, and the other includes those cathodes which consist of a heated metal surface or base metal coated with a layer of another material of lower work function.

The pure metal cathodes are almost always made of tungsten wire which is heated by the passage of an electric current. The wire is arranged in loops or spirals properly supported and equipped with connecting leads to the outside of the tube.

The compound cathodes may be in the form of directly heated wire or ribbon loops or spirals or may consist of cylinders heated by a separate internal heater. The cylinders often have discs or vanes welded to them to increase the emitting surface.

In gas-discharge tubes, the cathode structure may be enclosed in heat shields which reduce the heat loss and so increase the emission efficiency.

The various types of thermionic cathodes as well as other methods of liberating electrons will now be considered in greater detail.

16. Pure tungsten cathodes.⁶ The foregoing discussion of electron emission applies directly to the pure metal cathodes without modification.

It is desirable in the design of any electron tube to obtain the required emission current with the least possible expenditure of cathode heating power. For this reason, the emission efficiency of the cathode is of the greatest importance. The emission efficiency increases rapidly with temperature, but the rate of evaporation of the metal also increases, and, consequently, an operating temperature must be selected which gives the largest emission efficiency consistent with a useful life. In practice, pure tungsten filaments are operated at about 2550° K. At this temperature, the emission efficiency is 6.1 milliamperes per watt, and the expected life will be several thousand hours. The characteristics of any tungsten filament operating at 2550° K may be calculated

with the aid of the above emission efficiency and the following equations:

$$I = 6690 d^{3/2}$$

$$W = 1550 ld$$

where

I is the heating current in amperes.

W is the filament power in watts.

d is the filament diameter in inches.

l is the filament length in inches.

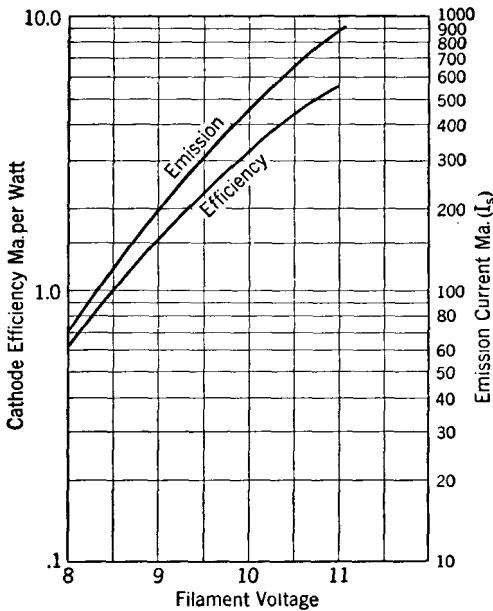

FIG. 9. The emission efficiency and emission of a pure tungsten filament. This filament is rated at 11.0 volts.

These two equations apply to a straight wire radiating freely. Allowance must be made for heat radiation or reflection from other portions of the filament or electrodes and conduction losses along connections and supports.

Fig. 9 shows the relation between total emission current, emission efficiency, and filament heating voltage for a typical case. The data were taken with the circuit of Fig. 10. The

emission current is simply the value of I_s , and the emission efficiency is:

$$\text{Emission efficiency} = \frac{I_s}{E_f I_f} \text{ milliamperes per watt.}$$

Obviously, in making tests of this kind, the anode voltage must be kept high enough so that all the emitted electrons will be drawn away from the filament.

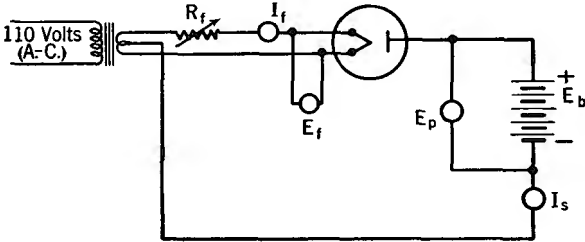

FIG. 10. Circuit for measuring the emission of a high-vacuum tube.

17. Thoriated-tungsten cathodes.⁷ It has been found possible to increase the emission efficiency of tungsten by adding one or two per cent of thorium oxide to the wire. Thoriated wire is used in filamentary cathodes the same as pure tungsten wire.

After the gas has been removed from the tube, the thoriated filaments are heated to about 2800°K for a few minutes. During this forming process, some of the thorium oxide is reduced to metallic thorium. The thorium atoms diffuse to the surface of the wire but, at this temperature, are evaporated at once. The temperature is then lowered to about 2200°K , and the consequent lowered evaporation rate permits the thorium atoms to spread out over the surface of the tungsten.

It has been found that the rate of evaporation of thorium atoms from a tungsten surface is very much less than the rate of evaporation of thorium atoms from a thorium surface. Consequently, the first layer of thorium atoms is held tightly to the tungsten and all succeeding layers evaporate off. The result is a tungsten wire carrying a

monatomic layer of thorium atoms. For this reason, the thoriated wire may be operated at a temperature which is near the melting point of thorium without excessive evaporation. This fact coupled with the lower work function of the composite surface accounts for the large increase in emission efficiency.

A further improvement is effected by flashing the thoriated wire in the presence of a hydrocarbon gas, such as naph-

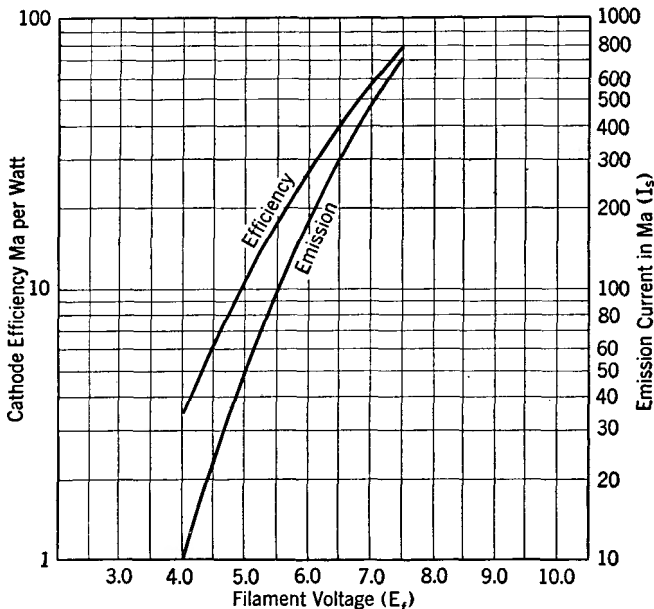

FIG. 11. Emission and emission efficiency for a tube using a thoriated-tungsten filament. The tube with which these data were taken has a filament rating of 7.5 volts.

thalene or acetylene. This treatment changes the surface of the tungsten wire to tungsten carbide. This carbonized wire is then activated in the way described above. The rate of evaporation of thorium from tungsten carbide is even less than that from pure tungsten, and, consequently, carbonized wires may be operated at higher temperatures than uncarbonized wires.

The rate of evaporation from the surface and the rate of

diffusion of thorium atoms from the interior of the wire to the surface are both dependent upon temperature. For each temperature there is an equilibrium condition or balance between the rate of arrival and rate of loss of thorium. This results in a different percentage of wire surface covered for each temperature. In addition, the work function of the composite surface varies with the amount of surface covered. These facts make the exact calculation of the characteristics of thoriated filaments much more complicated than similar calculations for pure tungsten. Nevertheless, for the usual operating temperature of about 2000° K, the characteristics may be predetermined with fair accuracy by using an emission efficiency of 85 milliamperes per watt and the following formulas:

$$I = 4150 d^{3/2};$$
$$W = 485 ld.$$

In practice, heat reflected from surrounding electrodes usually raises this emission efficiency to about 100 milliamperes per watt.

Fig. 11 shows the emission characteristics of a typical tube using a thoriated filament. Data for these curves were taken with a circuit similar to that shown in Fig. 10.

18. Coated cathodes.^{5, 8} Another very useful form of cathode is formed by coating a metal surface with a mixture composed chiefly of barium and strontium carbonates.

They are made in a large variety of forms. In high-vacuum tubes, the cathode consists either of a coated wire heated by current flow or a coated cylinder heated by an internal heater. The base metals most commonly used are nickel or special nickel alloys.

In gas-filled tubes, it is possible to raise the emission efficiency many times by thermal insulation. When this is done, less power is needed to maintain the active surface at the proper temperature. Heat-insulated cathodes usually take the form of a cylinder upon which are mounted radial vanes or discs. The outer surface of the cylinder and the

vanes is coated. The whole structure is surrounded by three or four concentric, closely spaced, polished metal cylinders which reduce the amount of heat lost by radiation from the cathode. These heat shields are penetrated by openings in the sides or ends to allow the flow of current from the coated parts. The cathode proper is maintained at the correct operating temperature by a tungsten heater mounted inside the inner cylinder. Some high-efficiency cathodes are made by winding coated ribbons in a zigzag fashion so that one section of the ribbon acts as a partial heat shield for the adjacent parts. A group of such cathodes is shown in Fig. 4.

Indirectly heated cathodes have been built which will deliver several thousand amperes of electron emission. Many of these heat-shielded cathodes operate with an emission efficiency as high as 200 to 1000 milliamperes per watt.

There is a wide divergence of opinion concerning the best ways of preparing and activating coated cathodes. Usually, however, the base metal is coated by dipping or spraying on one or more layers of a finely ground mixture of barium and strontium carbonates suspended in water. After coating, the cathodes are baked to remove the water.

Activation of the finished cathode consists of a thorough degassing and then heat treatment at 1300 to 1400° K to reduce the carbonates to oxides. Further heat treatment or "sintering" reduces part of the oxides and forms a layer of metallic barium. Some manufacturers prefer to draw current from the partially activated cathode to complete or accelerate the activation.

There are two conflicting opinions concerning the exact mechanism of emission from coated cathodes. One school believes that the emission comes from a layer of metallic barium on the surface of the core metal. The other school believes that the emission comes from a layer of metallic barium on the outer surface of the coating. Both theories

are upheld by considerable experimental evidence. At present, the latter theory seems to have the better foundation.

Measurements of the emission constants have been made by many investigators but the various results do not agree well because the observed emission depends so largely on the technique of coating and activating.

The most probable theory is that the emission comes from a layer of metallic barium on the outer surface of the coating.

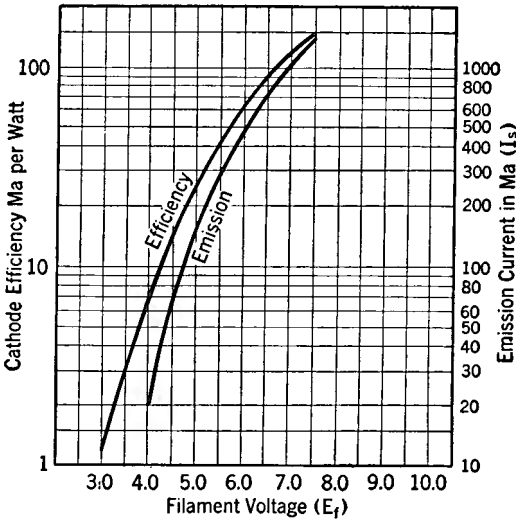

FIG. 12. The electron emission and emission efficiency for a tube using a barium-coated filament. The tube with which these data were taken is operated with a 7.5 volt filament supply.

The low work function which has been observed is supposedly due to the presence of barium ions adsorbed on the outer surface. These adsorbed ions or adions produce an electric field with a polarity which helps electrons to escape and so, in effect, lowers the work function.

Coated cathodes are usually operated at a temperature of about 1120° K. To maintain this temperature, a freely radiating coated cathode requires about 35 watts per square inch and furnishes about 1.75 amperes emission per square

inch. These data correspond to an emission efficiency of 50 milliamperes per watt.

This is a conservative rating of emission efficiency which may be relied on in practice. Here, also, the value is usually raised by the shielding effect of surrounding electrodes.

The emission per square centimeter and the emission efficiency vary considerably with exhaust and activation methods. Values of emission efficiency up to several hundred milliamperes per watt have been reported.

Fig. 12 gives the emission characteristics for a typical coated cathode.

19. Schottky effect.^{2, 5} Although the Schottky effect is not large enough to have any importance in the practical application of electron tubes, it serves as an introduction to the phenomena of field emission which is of considerable importance.

As we have already seen, the Schottky effect is responsible for a slight increase in electron emission over the value given by the thermionic emission equations. The magnitude of the effect can be found from the following relation derived by Schottky:

$$i_E = i_T e^{4.39E^{\frac{1}{2}}/(T)}$$

where

E is the field strength at the surface of the cathode in volts per centimeter.

i_T is the thermionic emission at temperature T given, for example, by Dushman's equation.

i_E is the actual current flowing in the presence of the electric field E .

Calculations, using Schottky's equation, show that, to get a 10 per cent increase in emission from a filament operating at 2500° K, we would need a field of more than 3000 volts per centimeter at the surface of the filament.

This equation holds very well for pure metal surfaces but not for thoriated filaments or coated metals.

In general, the emission from a compound surface shows

a larger dependence on field strength, and the saturation is much less pronounced or absent.

Thus we see that the saturation levels of Fig. 8 are not true saturation effects because the increasing electric field causes a slightly larger current to flow.

20. Field emission.² In our discussion of the Schottky effect we have seen how the electric field at the surface of the cathode can, in effect, reduce the work function. It would seem that, if the electric field were made very high, the work function could be reduced so much that large electron currents would flow even at low temperatures. This effect has been observed and studied by many experimenters.

The results of these tests show that large currents can be drawn from metals, even at room temperature, with field strengths of the order of 10^6 volts per centimeter. The effect is almost independent of temperature (at least up to about 1000° K), a fact which is in accord with the present concept of electron energy distribution in metals.

On the basis of these theories, the following relation has been derived:

$$i = ME^2\epsilon^{-N/(E)}$$

where M and N are constants characteristic of the metal and E is the field strength. So far, the difficult experimental technique has prevented our learning very much about the values of M and N .

However, recognition of these difficulties has been very valuable in the development of high-voltage electron tubes. In particular, field emission, or cold-cathode emission as it is sometimes called, is increased markedly by adsorbed layers of electropositive elements and, in some cases, by adsorbed gases. Small irregularities, such as ridges or sharp points on the metal surface, increase the field emission enormously because such points or ridges become the locus of electric fields much higher than the field over the rest of the surface.

The undesirable effects of field emission can be minimized by avoiding electrode structures with sharp edges or angles.

The electrode surfaces should be smooth and thoroughly outgassed.

21. Secondary emission.⁵ Electrons may be liberated by bombarding a surface with high-speed electrons, ions, or other particles. The electrons liberated in this way are called secondary electrons to distinguish them from the bombarding or primary particles. Secondary emission due to the impact of positive ions or metastable atoms is recognized as an effect which does occur, but very little is known about the magnitude. Positive ions of 1000 volts velocity will produce secondary electrons, but the number is usually less than 10 electrons for each 100 impacts. At higher voltages, the effectiveness probably increases, but there are few or no comprehensive data to confirm this supposition. Metastable atoms seem to be somewhat more effective, but, here again, the available data are scarce.

On the other hand, impinging electrons are very effective agents in the production of secondary electrons. The yield of secondary electrons increases with voltage to a maximum in the range from 200 to 400 volts and then decreases slowly for higher voltages.

The height of this maximum depends largely on the surface condition of the target and the kind of material. The presence of gas in or on the target surface usually increases the emission. Surface deposits of the electropositive metals increase the yield many fold.

For clean, well-degassed metals, the maximum number of secondary electrons driven out for each primary impact is usually about 1.0 or slightly more. The yield from surfaces which have not been well cleaned or degassed may be as high as 3 to 1. A surface layer of cesium may give as many as 10 secondary electrons for each primary electron.

Secondary emission phenomena are not used commercially to any great extent but do cause undesirable effects which must be recognized and eliminated.

22. Photoemission.^{9, 10} The history of the photoelectric effect begins with the observation by Hertz that the break-

down potential of a spark gap illuminated by ultra-violet light was lower than a similar gap without the illumination. The effect was studied in great detail by many observers and has become extremely important from the commercial as well as the purely scientific viewpoint.

In brief, experiment shows that incident light will cause the ejection of electrons from the surface of many metals. The effect is most pronounced for metals like sodium (Na), potassium (K), cesium (Cs), barium (Ba), and less for metals like tungsten (W), zinc (Zn), cadmium (Cd), and magnesium (Mg).

A comprehensive theory of the effect was lacking until Einstein proposed his photoemission equation in 1905. Einstein's equation is based on the quantum theory of radiation which teaches that light is made up of energy bundles or quanta. The kinetic energy associated with the energy bundles or light darts is equal to the frequency f multiplied by Planck's constant h . Einstein suggested that the kinetic energy of the ejected electrons is equal to hf , the amount given to the emitting surface by the incident light, minus ϕe , the amount of energy necessary to overcome the work function of the surface. That is: $KE = hf - \phi e$ is the kinetic energy of the electrons which have escaped. We see at once that there will be a value of frequency f_0 for which the excess kinetic energy is zero. The energy from the incident light at frequency f_0 is just enough to overcome the work function. Therefore, light of frequency less than f_0 will cause no photoemission at all, no matter how intense the light source may be. From Einstein's equation we find that the kinetic energy is zero when:

$$hf_0 = \phi e.$$

Substituting for f_0 the corresponding wavelength λ_0 and evaluating the constants gives the relation:

$$\lambda_0 = \frac{12,336}{\phi}$$

where ϕ is the work function of the surface in volts and λ_0 is the long wave limit in Ångström units.* Theory and experiment agree that photoelectrons will not be ejected from a surface unless the wavelength of the incident light is less than the long wave limit λ_0 fixed by the work function of the surface. Table VI gives the measured long wave limits of a group of metals.

The chart of Fig. 13 gives a rough correlation of wavelengths and the primary colors.

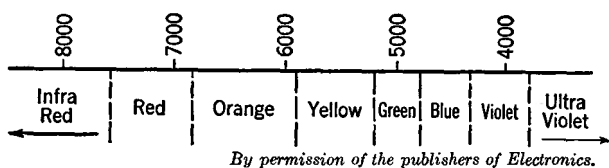

FIG. 13. Chart to show the approximate relation between the wavelength and color of visible light.

Einstein's equation also shows that the kinetic energy, and therefore the initial velocity, of the photoelectrons are functions of frequency only. This is borne out by experiments which show that the sensitivity of a surface increases steadily from the long wave limit to a maximum which is usually in the short wavelength part of the spectrum. The wavelength at which the maximum sensitivity occurs varies with the metal as shown in Table VI.

The work function of the surface can be found by measuring the initial velocity of the electrons ejected by light of a known frequency. The work function found in this way may differ considerably from the thermionic work function. There is good reason to believe that the two are identical, particularly in view of careful experiments, made by Du Bridge on platinum, which gave the results shown in Table VI.

Ordinary white light contains many frequencies or colors in varying proportions. The curve which represents the

* 1 Ångström unit = 10^{-8} cm.

TABLE VI

Metal	Long Wave Limit λ_0	Photoelectric Work Function	Thermionic Work Function	Wavelength of Maximum Sensitivity
Pt	1962	6.30	6.27	
Ag	2610	4.73	4.08	
W	2650	4.58	4.52	
Ca	4475	2.70	3.02	
Na	5000	1.9-2.46		3400
Li	5400	2.1-2.9		3000
K	5500	1.76-2.25		4400
Cs	6600	1.9	1.81	4800
Cs-CsO-Ag	> 10,000			

proportion of total energy radiated at each frequency is called the spectral distribution curve.

The photoelectric current given by any surface varies linearly with the light intensity provided the spectral distribution remains constant.

The use of photoemission phenomena in phototubes^{11, 12} will be discussed in greater detail later in the chapter.

23. Space charge.^{2, 13, 14} We have found, in studying our hypothetical vacuum tube, that two distinct phenomena coöperate to produce the characteristic curves shown in Figs. 7 and 8.

The complete journey of the electron current is therefore governed by two sets of laws: first, the principles of electron emission which control the passage of the electrons from the interior of the cathode material through the surface; and, second, the space charge laws which deal with the electron flow from the surface of the cathode to the anode. We have seen how the first of these effects operates to limit the number of electrons which flow through the cathode surface, and now we must inquire into the further limitations imposed by space-charge effects during the rest of the journey. Space-charge limitation is due, as the term suggests, to the presence of electrical charges in the inter-electrode space.

Although the initial velocity of the electrons will cause a few to cross to the anode, large currents will not flow unless huge numbers of electrons be drawn away from the cathode surface across the interelectrode space to the anode. In our experimental tube, this is accomplished by raising the anode to a potential positive with respect to the cathode. The positive charge on the anode establishes an electric field throughout the whole interelectrode space which causes

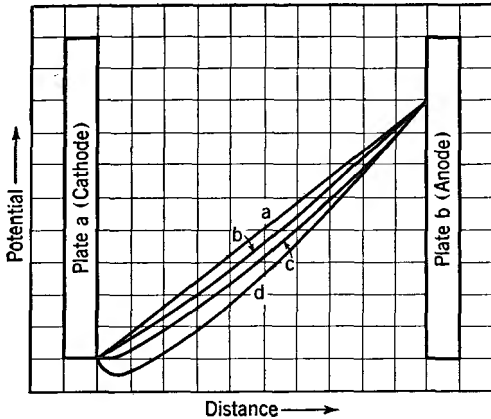

FIG. 14. The potential distribution between plane parallel plates with various degrees of space charge.

- (a) zero space charge.
- (b) current emission limited; small space charge.
- (c) current space charge limited.
- (d) potential depression near cathode due to initial velocity of electrons.

the electrons to flow from the cathode to the anode. The transfer of these charges constitutes an electric current which flows from cathode to anode within the tube and back to the cathode through the battery or other source of anode potential.

The effect of the anode potential is distributed throughout the space according to definite laws. By means of these laws, the potential

distribution may be calculated in certain cases. Consider two parallel flat plates *a* and *b*, Fig. 14, maintained at a potential difference V by a battery. If the effects of the edges are disregarded, the potential distribution between these plates will be linear. That is, the distribution is such that half way between the plates the potential is $V/2$. A third plate having a potential of $V/2$ could be placed parallel to the original two and midway between them without disturbing the conditions at either

plate. Similarly, one-quarter the distance from the reference plate, the potential will be $V/4$. In this case, the potential gradient — or rate of change of potential with distance — is a constant.

For other shapes of electrodes, the distribution is non-linear. In any case, there cannot be a point of maximum potential in the space between electrodes unless that point is occupied by a positive charge; and, conversely, there cannot be a region of minimum potential unless that region is occupied by a negative charge.

Suppose that these two, flat, parallel plates constitute the cathode and anode of our high-vacuum tube and that the anode is maintained at a positive potential V with respect to the cathode. The potential distribution will be given by curve (a) of Fig. 14 so long as the cathode is cold and non-emitting. As the cathode temperature is raised, electrons are emitted and are continuously drawn away to the anode by the electric field. The potential distribution then becomes something altogether different. The inter-electrode space now contains a cloud of electrons, and the potential at every point between cathode and anode is reduced by the negative charge of the electrons. We see that the potential distribution is changed by the passage of the current. This altered potential distribution is shown by curve (b). There is still an accelerating field at the cathode surface, and every electron which is emitted is drawn away; that is, the current is still emission-limited.

Since the electron velocity increases continuously from cathode to anode, and since the current is constant everywhere, the density of the electron cloud is large near the cathode but decreases toward the anode. It is this cloud of electrons which constitutes the space charge; and the lowering of the voltage in the space occupied by the cloud of electrons is known as the space-charge effect.

If the cathode temperature be increased again, more electrons will be emitted, the plate current will increase, and the potential distribution will be changed again.

Further increases in emission will eventually change the potential distribution to correspond to curve (*c*). Here the electric field at the cathode surface has been reduced to zero. No more electrons can be drawn away from the cathode because any excess emission will produce a potential minimum close to the cathode surface similar to curve (*d*), and additional electrons are then confronted by a retarding field which returns them to the cathode and, so, prevents their escape. The value of the electric field or gradient at the cathode dictates how much of the available emission can flow to the anode.

From the foregoing discussion we see that the gradient is determined partly by the anode potential and partly by the negative charges of the electrons which comprise the plate current.

Consequently, for every value of plate voltage, there is a corresponding value of electron current which produces a space charge just sufficient to reduce the gradient at the cathode surface to zero. This is the maximum value of current which can flow regardless of how much emission is available. If the anode potential be changed, the current flow will also change to a new value which again is just sufficient to reduce the cathode gradient to zero.

This picture is slightly inaccurate because we have not taken into consideration the effect of the initial velocities of the electrons. Owing to this initial velocity, electrons can flow away from the cathode even when the gradient at the cathode is zero. The result is that the potential at the cathode is actually depressed below zero slightly and a potential minimum is formed. The true potential distribution corresponds to curve (*d*) of Fig. 14. At first thought, it might seem that electrons could never leave the cathode. We know, however, that the initial velocity does enable some of them to move against the retarding field and reach the accelerating field beyond the potential minimum. In this way, the higher-velocity electrons pass to the anode while the slower ones are sorted out and returned to the cathode.

This sifting process goes on automatically. Between the potential minimum and the cathode, newly emitted electrons are moving away from the cathode; but, at every point, the slower-moving electrons are being stopped and sent back. Those which reach the point of minimum potential are rapidly accelerated away by the electric field.

For any one anode voltage, the depth and position of the potential minimum are determined by the number of emitted electrons, which is, in turn, fixed by the cathode temperature. For this reason, raising the cathode temperature causes a larger retarding field at the cathode surface and only a very small increase in electron current since the deeper potential barrier returns the increased emission to the cathode.

We can now explain the curves of Figs. 7 and 8 in detail. In Fig. 7, we know that, as the cathode temperature is increased, the emission, and with it the current, will increase. There is then a region AB of the upper curve (E_p equal to 3) where the current is limited entirely by emission. However, each increment in current causes a corresponding increase in space charge which progressively lowers the electric field gradient at the cathode surface. Finally, in the neighborhood of point B , the electric field becomes incapable of drawing away the increased number of electrons and the current ceases to rise. Consequently, no increase in current is brought about by raising the filament current to 5, 6, or 7 units because the additional emission cannot be used. The current in region BC is said to be space-charge-limited.

If the plate potential had been 2 units instead of 3, the cathode gradient would have been reduced to zero with a lower value of electron current.

In Fig. 8, the same two effects are brought into play but in the reverse order. Here the cathode temperature is fixed and the anode potential increased from zero. Throughout the range LM , there is an excess of emission and, as the voltage is raised, more and more of the electrons are drawn to the anode. All through this region enough electrons are emitted to maintain the potential minimum at the cathode.

In the neighborhood of point M , most of the electrons are drawn away as fast as they are emitted. Further voltage increase will destroy the potential minimum and draw away all the emitted electrons. From this point on, the current is emission-limited.

The problem has been analyzed mathematically by Langmuir, Child, and others for the geometrical arrangements ordinarily used.

The two most useful forms of the space-charge equation have been expressed by Langmuir as follows:

a. Cathode and anode are parallel planes.¹³

$$i = \frac{V^{3/2}}{9\pi x^2} \sqrt{\frac{2e}{m}}$$

or

$$i = 2.33 \times 10^{-6} \frac{V^{3/2}}{x^2} \text{ amperes per square} \\ \text{centimeter area of cathode}$$

where

V is the potential difference in volts.

x is the electrode spacing in centimeters.

b. Cathode and anode are co-axial cylinders.¹⁴

$$i = \frac{2\sqrt{2}}{9} \sqrt{\frac{e}{m}} \frac{V^{3/2}}{r\beta^2}$$

or

$$i = 14.65 \times 10^{-6} \frac{V^{3/2}}{r\beta^2} \text{ amperes per centi-} \\ \text{meter length of axis}$$

where

r is the anode radius in centimeters.

β^2 is a function of ratio of cathode and anode radii.

Values of β^2 are given in the Appendix.

These equations are applicable to current flow carried by electrons or ions provided the proper values of e and m are used. The numerical evaluation given above applies only to

electron currents. These equations give the maximum value of current which can flow with a voltage V on the anode.

Each electron hits the anode and gives up its kinetic energy at the impact in the form of heat. This fact establishes one of the limits upon the amount of power which any given tube can handle. The anode power loss is always equal to the anode current multiplied by the voltage between anode and cathode.

In this treatment of space charge, no consideration has been given to the effect of the remaining gas molecules. These molecules play an extremely important part.

It is certain that some of the gas molecules will become ionized by electron impact. These ions have a positive charge, and because their mass is large, they remain in the space a long time compared to the electrons. They will neutralize some of the effect of the negative charges of the electrons and raise the space potential, thus permitting more electron current to flow. A relatively small number of ions can neutralize so much of the space charge that the foregoing equations will not hold. If enough ions are present, the discharge may become unstable and the flow of electron current may become so great as to destroy the tube by overheating the anode.

It is very important, then, to have as few remaining gas molecules as possible in order to maintain a stable relation between current and voltage.

The gas molecules are removed by pumping out or "exhausting" the tube. In this connection, it should be remembered that all the materials that go to make up the tube contain gas either adsorbed on the surfaces or occluded in the material. This gas must be driven out by heating the parts and removing the gas with a pump. Even after a prolonged heat treatment, much gas is left in the parts and will be liberated if tube parts are heated above the temperature reached during the exhausting operation. Severe overheating of a finished tube may liberate enough gas to destroy it, either by neutralizing the space charge or by

spoil the cathode, particularly if it is a coated or thoriated cathode. Sometimes positive ions will bombard a spot on the glass wall of the tube with sufficient intensity to overheat the glass and melt a hole in it.

In many tubes further exhaust is effected by introducing into the tube a small amount of magnesium wire or a pellet of calcium which, after the tube is finished, is melted and

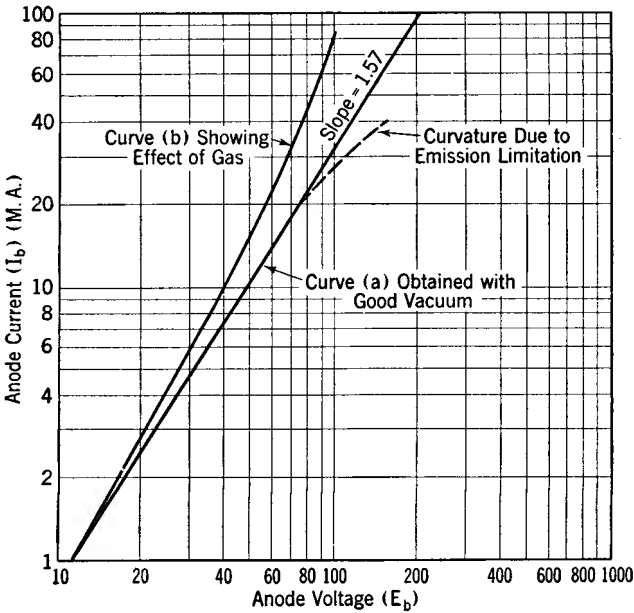

FIG. 15. A logarithmic plot of the volt-ampere characteristic of a high-vacuum tube. If the current is limited by space charge, the resulting plot will be a straight line.

allowed to condense on the glass wall of the tube. This coating serves to occlude a large amount of gas while it is condensing and also combines with certain gases which may be evolved during the tube life. A material put in the tube for this purpose is called a "getter."

The validity of the space-charge equations may be verified by comparing calculations with experimental data. If the experimental data be plotted on log-log graph paper, the

relation between anode voltage and current will be represented by a straight line. The slope of this line will be the numerical value of the exponent of the voltage term in the space-charge equations. Curve (a) of Fig. 15 illustrates the result of plotting experimental data on a typical high-vacuum tube. Deviations from the true space-charge law caused by ionization of residual gases are exhibited in curve (b) of Fig. 15.

Such deviations from the space-charge, or $3/2$ power, law are often used as a measure of the residual gases.

BIBLIOGRAPHY

1. Emission of Electricity from Hot Bodies, O. W. RICHARDSON, Longmans, Green & Co., 1921.
2. Electrical Discharges in Gases (Parts 1 and 2), K. T. COMPTON and IRVING LANGMUIR, Reviews of Modern Physics, April, 1930, and April, 1931.
3. Thermionic Emission, SAUL DUSHMAN, Reviews of Modern Physics, October, 1930.
4. Electron Emission, SAUL DUSHMAN, Electrical Engineering, July, 1934.
5. Physics of Electron Tubes, L. R. KOLLER, McGraw-Hill Book Co., 1934.
6. Characteristics of Tungsten Filaments as Functions of Temperature, H. A. JONES and IRVING LANGMUIR, General Electric Review, July, 1927.
7. The Electron Emission from Thoriated Tungsten Filaments, IRVING LANGMUIR, Physical Review, pp. 357, 1923.
8. Phenomena in Oxide-coated Filaments, G. A. BECKER, Physical Review, pp. 1323, 1929, and pp. 2193, 1931.
9. Photo Electricity, H. STANLEY ALLEN, Longmans, Green & Co., 1925.
10. Photo Electric Phenomena, A. L. HUGHES and L. A. DU BRIDGE, McGraw-Hill Book Co., 1932.
11. Characteristics of Photoelectric Tubes, L. R. KOLLER and H. A. BREEDING, General Electric Review, September, 1928.
12. The Photoelectric Cell, L. R. KOLLER, General Electric Review, July, 1928.
13. The Effect of Space Charge and Initial Velocities on the Potential Distribution and Thermionic Current between Parallel Plane Electrodes, IRVING LANGMUIR, Physical Review, April, 1923.
14. Currents Limited by Space Charge between Co-axial Cylinders, IRVING LANGMUIR and KATHARINE B. BLODGETT, Physical Review, October, 1923.

CHAPTER IV

TWO-ELECTRODE TUBES

24. High-vacuum phototubes.^{1, 2, 3} A phototube can be made by incorporating an electrode which gives a large emission of electrons in the presence of light, and another electrode to collect the electrons in an evacuated chamber. The first or photosensitive electrode is called the cathode, and in present-day tubes consists of some alkaline metal, such as cesium or sodium, deposited in the form of a very thin layer on the inner wall of the glass bulb or on a metal surface. The electron-receiving electrode is known as the anode.

Frequently, the cathode consists of a half-cylinder of metal mounted so that light transmitted through the tube wall will fall on the inner surface of the cylinder. The anode is a small wire mounted in the axis of the cathode cylinder.

One of the most sensitive photo-cathodes is formed by coating the cathode with silver which is later oxidized. Cesium is then distilled onto the silver oxide surface. Part of the cesium takes up the oxygen and becomes cesium oxide. The finished sensitized surface then consists of cesium on cesium oxide on silver.

If a battery be connected to the two electrodes of such a device, so that the anode is positive and the cathode negative, practically no current will flow through the evacuated space if there is no light falling on the cathode. However, if light is allowed to fall on the cathode, a small current of electrons will flow from the cathode to the anode. The amount of current which flows is very nearly proportional to the amount of light falling on the sensitive surface. Consequently, if a graph be made to show the relation be-

tween the electron current and the incident light, the resulting curve will be very nearly a straight line.

This relationship, for a typical phototube, can be found with the arrangement shown in Fig. 16. For this test, the light source should be one that is capable of delivering about 4 lumens over the area of the semicircular plate or cathode of the phototube and should be so arranged that the flux of light can be varied uniformly. A convenient source for the purpose is a 75-watt Mazda lamp in a box having a

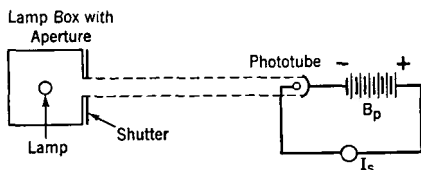

FIG. 16. Apparatus for determining the relation between light intensity and anode current in a phototube.

window the size of the phototube cathode and a shutter which will vary the area through which the light passes to the phototube. An intensity of light adequate for the maximum readings will be obtained if the lamp box is located about a foot from the phototube and is so placed that the beam falls directly on the inner surface of the phototube cathode. For accurate results, little or no light should be permitted to fall on the cathode from any other source.

With this equipment, a variation of the aperture area of the shutter will cause a variation in the electron current I_s . Because the amount of light reaching the phototube cathode is directly proportional to the area of the aperture, the response of the phototube may be indicated by a curve showing the relation between the varying areas of shutter aperture and the corresponding electron current. The curve in Fig. 17 is typical of the characteristic of vacuum phototubes in that it shows the proportional response of such tubes to light of varying intensity.

With a known light source, under the testing conditions described, the sensitivity of a phototube can be determined in microamperes of electron current per lumen of incident light.

This characteristic was taken with a tube having a

Cs-CsO-Ag cathode. The sensitivity of the tube as shown by this curve is 5 microamperes per lumen. Even more sensitive tubes are made by depositing a thin film of silver on top of the cesium. This cathode structure, Ag-Cs-CsO-Ag, will give a sensitivity of 30 to 60 microamperes per lumen.

Very low anode voltages are needed to draw all the emission to the anode. The tube we have been discussing has a volt-ampere characteristic like that shown in Fig. 18.

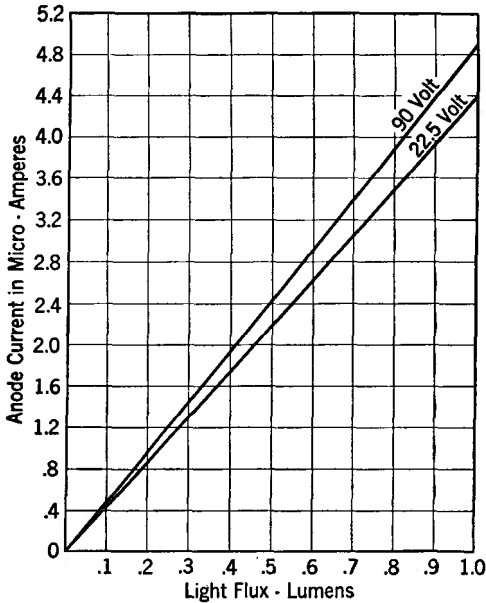

FIG. 17. The relation between the anode current and the light flux in a typical vacuum phototube.

According to this characteristic, the anode voltage need not be more than about 25 volts. At higher voltages, say 90 volts, the current is practically independent of voltage — a feature which may be of value where supply voltage variations are troublesome.

It is always advisable to use the lowest voltage and illumination consistent with the desired result. Adherence to these rules will give the most satisfactory life and stability of operation.

Phototubes may be made to give their maximum sensitivity in almost any part of the spectrum by using different combinations of cathode materials. Thus, we have blue-sensitive tubes, red-sensitive tubes, and tubes with quartz bulbs which give practically no response to anything but ultra-violet light. Further discrimination can be obtained by using color filters.

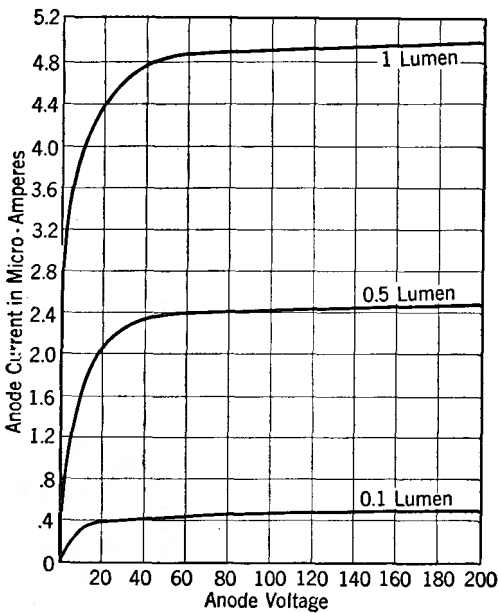

FIG. 18. The volt-ampere characteristic of a typical high-vacuum phototube.

25. Gas-filled phototubes.¹ The gas-filled phototube is much the same as the high-vacuum phototube in construction. It differs in that it contains some inert gas, such as argon, at a pressure of about 100 microns. The sensitivity of the device is increased because the electrons liberated at the cathode, photoelectrically, are accelerated by the anode voltage and ionize the gas. The electrons freed by ionization add to the original or primary electrons and increase the current flow. The positive ions flow back to the cathode

and produce a current in the same sense as the electron current. They, therefore, also increase the current flow.

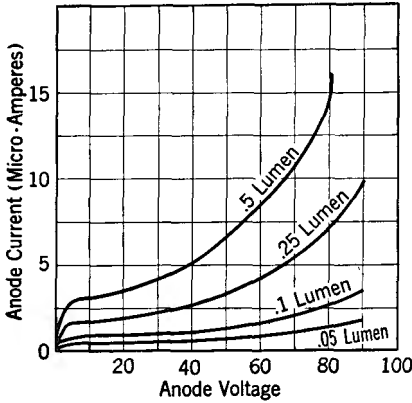

FIG. 19. The relation between the anode voltage and current for a typical gas-filled phototube.

general like the curve of Fig. 19. The variation of current with light flux is illustrated by Fig. 20.

Care must be exercised in the design of apparatus to use these tubes to prevent the occurrence of too much anode voltage or cathode illumination. Excess light or voltage can increase the ionization enough to form a glow discharge. After the glow discharge sets in, the anode current will no longer respond to changes in light intensity and the tube may be destroyed.

The two kinds of phototubes have another point of difference. If the light be interrupted rapidly, or chopped, the anode current of the vacuum

By this mechanism the sensitivity may be increased five to ten fold depending on the voltage.

The increased sensitivity due to gas ionization is called the gas amplification ratio. This is the ratio of anode current at the operating voltage to the anode current with an anode voltage so low that ionization is unimportant.

The volt-ampere characteristic varies greatly with gas pressure but is in

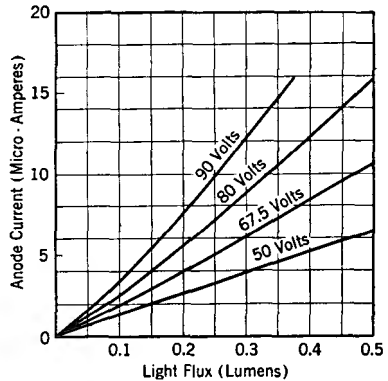

FIG. 20. Relation between light flux and anode current in a typical gas-filled phototube.

phototube will vary accordingly, and the amplitude will not be affected greatly by frequency. The amplitude of the anode current pulses from the gas-filled tube will decrease as the frequency increases because the heavy gas ions cannot move fast enough to give the full amplification ratio. This time lag is noticeable even at low frequencies but becomes more and more pronounced above 500 cycles.

26. Selenium tubes.⁴ The selenium tube is not an electron tube in the same sense as the other devices we have considered. It is a photosensitive device used in much the same way as a phototube.

Selenium tubes utilize the variation in ohmic resistance exhibited by the element selenium when it is illuminated. The cell consists of some arrangement of electrodes separated by a thin layer of selenium. One of the most common constructions consists of a glass sheet covered with a thin gold plating which is cut in a zigzag fashion to provide two electrodes separated by a narrow cut. Selenium is spread over the electrodes and the cut and annealed to give the desired photo property.

The whole plate is mounted inside an evacuated bulb fitted with appropriate leads and connectors.

The current which flows depends on the impressed voltage and light. The maximum value is limited by the heat developed and by the voltage which will cause breakdown between the gold grids.

The current response to illumination is not linear as it is in the phototube. The current change is proportional to the square root of the light intensity and therefore is largest for low values of illumination. The output under all conditions is larger than the corresponding size of phototube.

There are several drawbacks to the use of selenium tubes. The output is not as stable and reliable as it is in a phototube. Another disadvantage is a time lag very similar to the lag in a gas-filled phototube. This time lag is apparently a composite effect and is not well understood. Lastly, there is a residual current, called the dark current, which

flows by reason of the finite resistance of the tube with zero illumination.

All these facts must be considered when choosing between a phototube and a selenium tube.

27. Two-electrode thermionic tubes or diodes. The diode is the simplest form of thermionic electron tube and is

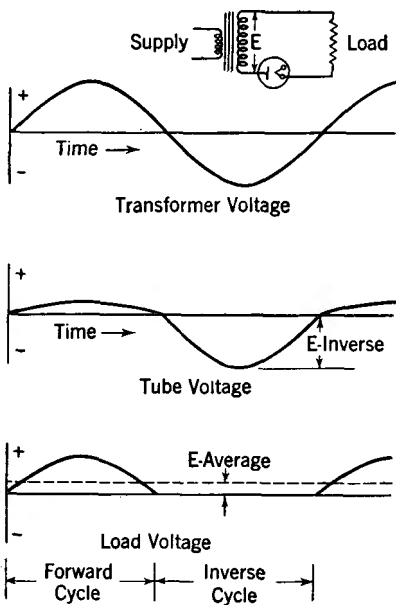

FIG. 21. Simplified chart of the voltage relations in a half-wave rectifier with a resistance load and no filter.

the type which was used in our study of electron emission and space-charge phenomena. For this purpose, we discussed two electrode tubes, considering, not the tube primarily, but rather the processes occurring within the tube.

The diode finds its widest application as a rectifier⁵ for converting alternating current and voltage to direct current and voltage. Use is therefore made of it in the power supply for radio transmitters and receivers, for high-voltage, cable-testing equipment, and for the high-voltage supply for X-ray equipment and smoke

precipitators. The tube is capable of performing this function because it will conduct current in only one direction. An electron current can flow from the filament to the anode but not from anode to filament. Consequently, if a diode be introduced in series in an alternating-voltage circuit, current flow will be permitted in only one direction. The result will be a pulsating, unidirectional current. In practice, this pulsating current is used to charge a condenser which, in turn, supplies the load circuit with a nearly uniform supply of direct current. Further uniformity is gained by the addi-

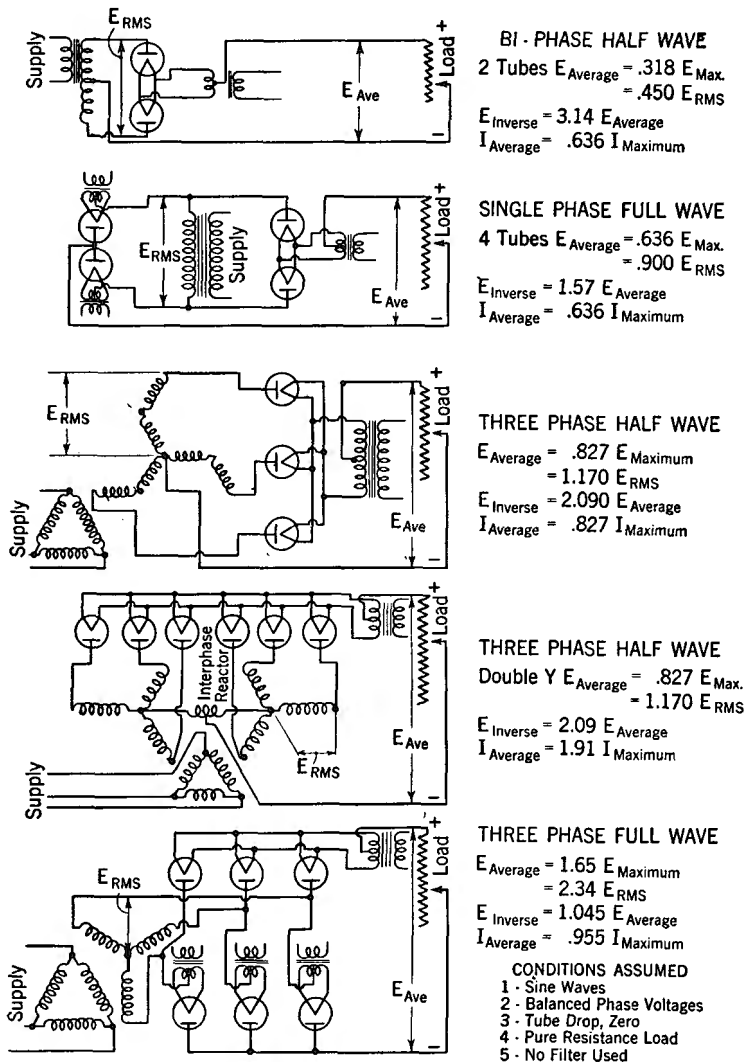

FIG. 22. Elements of various rectifier circuits and the Numerical ratios of the principal voltages and currents.

tion of a filter consisting of shunt capacitors and series inductors.

The operation of this simple rectifier circuit will be made clearer by reference to Fig. 21.

Such a rectifier, using one tube, is known as a half-wave rectifier because it utilizes only one-half the alternating-voltage supply. Other rectifiers may be built with two tubes to utilize both alternations in a single-phase circuit, or pairs of tubes per phase may be used in a polyphase circuit.

Fig. 22 gives the skeleton circuit and fundamental current and voltage relations for a number of rectifier circuits.

The diode acts as an insulator on the alternate half cycles. Consequently, when choosing the tubes to be used for any rectifier application, consideration must be given to the ability of the tube to withstand the open-circuit or "inverse" voltage as well as its ability to pass sufficient load current in the forward direction without overheating the anode.

The ability to perform these functions determines the safe voltage and current ratings given to the tube by the manufacturer.

BIBLIOGRAPHY

1. Physics of Electron Tubes, L. R. KOLLER, McGraw-Hill Book Co., 1934.
2. Operating Characteristics in Photoelectric Tubes, G. F. METCALF, Proceedings Institute Radio Engineers, November, 1929.
3. Characteristics of Photoelectric Tubes, L. R. KOLLER and H. A. BREEDING, General Electric Review, September, 1928.
4. The Selenium Cell, Its Properties and Applications, G. P. BARNARD, Journal Institute Electrical Engineers (London), 1928.
5. Rectifier Wave Forms, D. C. PRINCE, General Electric Review, September, 1924.

CHAPTER V

CONTROL OF ELECTRON SPACE CURRENTS

28. Single-grid tubes.^{1,2} In the two-electrode, high-vacuum tube with constant electron emission, the only way to control the electron current is to change the anode voltage.

It is possible, however, to gain further control by one of two means. The first and most important is the electrostatic control afforded by the addition to the tube of a third electrode made in the form of a grid. The second method is by the application of an electromagnetic field arranged to control the paths of the electrons.

In the electrostatic method, an electrode, usually made of wire mesh, is inserted in the tube between the cathode and anode in such a way that the cathode is totally enclosed.

This type of tube is known as a three-electrode tube or triode. It is, in fact, simply a diode with the grid added.

The ability that the grid has to control the electron current is explained on the basis of space-charge effects as described in Article 23. It has been shown that the current flowing through the tube depends on the voltage distribution throughout the tube and, in particular, the voltage near the surface of the cathode.

In the diode, the potential gradient at the cathode is determined by the geometrical character of the tube and the anode voltage. In the triode, it is made up of the sum of the field due to the grid and of the field of the anode. Furthermore, the grid is an electrostatic shield which reduces the field due to the anode.

Curve (A) of Fig. 23 shows the effect of a small negative grid voltage on the potential distribution throughout the tube. The field at the cathode is negative, and no current can leave even though there may be a large positive anode

voltage. The current is said to be cut-off, and the grid voltage which is just enough to reduce the plate current to zero is called the cut-off voltage. Curve (B) represents

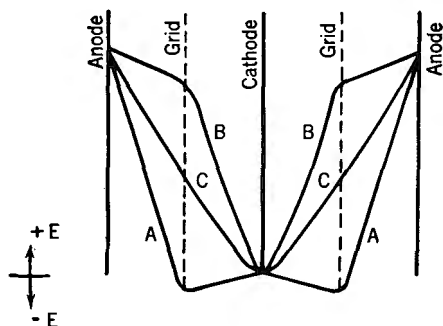

FIG. 23. The potential distribution in a hypothetical high-vacuum tube. Curve B shows the grid above normal space potential; in C the grid is at space potential; A shows the grid enough negative to produce a negative field at the cathode.

the potential distribution with the grid nearly as positive as the anode. The field at the cathode is now zero, and large space-charge-limited currents flow. The value of current under these conditions may be even greater than it is with the grid removed.

The equation which expresses the relation between the current flowing from the cathode as a function of the grid and plate* voltages is somewhat similar to the space-charge equations for the diode.

For parallel plane electrodes:

$$i = \frac{2.33 \times 10^{-6}}{x^2} \left(\frac{E_p + \mu E_g}{1 + \mu} \right)^{3/2} \text{ amperes per square centimeter of cathode surface.}$$

For cylindrical electrodes:

$$i = \frac{14.65 \times 10^{-6}}{r\beta^2} \left(\frac{E_p + \mu E_g}{1 + \mu} \right)^{3/2} \text{ amperes per centimeter length of axis.}$$

These equations were derived by reducing the triode to an equivalent diode. This is accomplished by supposing the grid to be replaced by a solid electrode. An equivalent voltage, expressed in terms of grid and anode voltage, must

* The word plate is the commonly used name for the anode. The two terms are synonymous.

be found which, when applied to the solid grid electrode, will give the same value of electric field at the cathode as the separate grid and anode voltages do. This equivalent voltage substituted in the diode equation will give the correct value of electron current leaving the cathode. The proper value of x or r to use with the above equations is, of course, the grid to cathode spacing or grid radius, depending on the type of structure.

In the plane parallel structure, the numerical value to use for cathode area is obvious for a heater-type cathode. If the cathode consists of a number of filaments, the proper value is not so apparent. Theoretical and empirical methods agree that a filament wire acts, so far as space-charge relations are concerned, like a ribbon having a width about equal to twice the grid-filament spacing. The proper area is then equal to twice the filament length multiplied by twice the spacing. In cylindrical structures, the above equation holds if the cathode is a heater type or a single axial wire. There is no satisfactory method of calculating the effective diameter of a cathode structure which consists of a number of wires spaced axially or helically on the surface of a cylinder.

Owing to the shielding effect of the grid, the field at the cathode can be changed more by a change of grid voltage than by an equal change of plate voltage. The relative influence of grid and anode voltages on the anode current is expressed by a characteristic tube constant called the amplification factor and designated by the Greek letter μ (mu). The effect of the shielding is shown by the appearance of μ in the expression for current flow.

Every value of field at the cathode determines a single value of space current, but these equations show endless combinations of grid and anode voltages which will give the same equivalent voltage. It is clear, therefore, that the volt-ampere characteristics of the device must be represented by a family of curves rather than a single curve.

The equations further show that varying the grid voltage

from some value negative with respect to the cathode to a value positive with respect to the cathode will change the current to the anode continuously from zero to a value even greater than could be obtained if the grid were absent. This control of current is possible regardless of the anode voltage, although different anode voltages will require different grid voltages.

The curves which show the relation between anode voltage, grid voltage, and grid or anode current are called the static characteristics. They may be plotted by using any

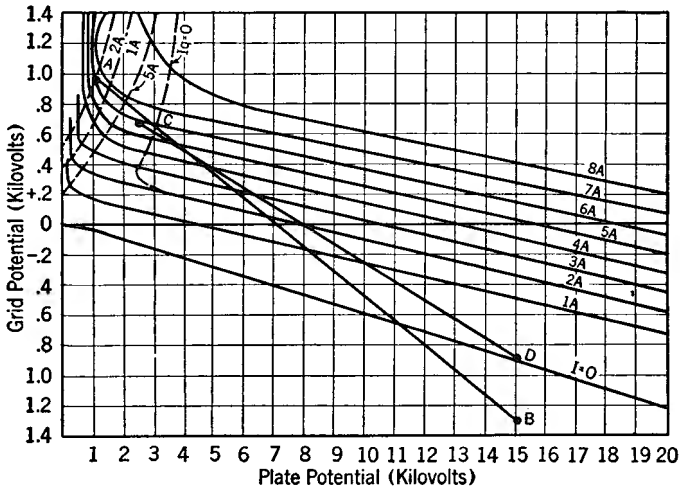

FIG. 24. A typical set of constant-current curves for a three-electrode, high-vacuum tube.

two of the quantities as variables and holding the third one constant. In this way, we plot constant-current curves, constant-grid-voltage curves or constant-anode-voltage curves. Fig. 24 shows a typical set of constant-current characteristics. Fig. 25 shows the constant grid voltage or plate characteristic for a different tube, and Fig. 26 presents the same data plotted with constant anode or plate voltage curves to give the so-called transfer characteristic. Although all three sets of curves contain the same information,

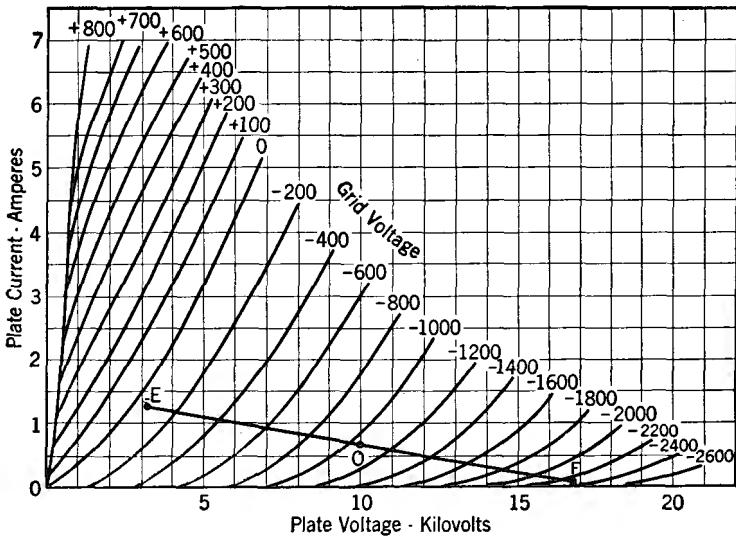

FIG. 25. One of the static characteristics of a three-electrode, high-vacuum tube commonly known as the plate characteristic. The line EOF is the "Class A" dynamic characteristic.

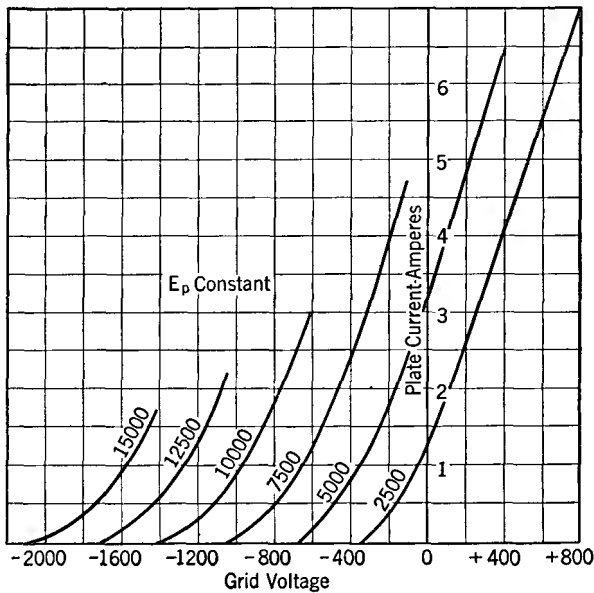

FIG. 26. The mutual or transfer characteristic of a high-vacuum, three-electrode tube.

it is sometimes more convenient to use one in preference to the others for the analysis of specific problems.

When the grid is negative with respect to the cathode, positive ions can flow to it, but electrons are repelled. However, if the tube is well exhausted, the number of positive ions which flow to the grid is small; usually the resulting current is only a few microamperes and can be neglected entirely. This means that, so long as the grid is maintained at a negative voltage, the plate current through the tube can be controlled by the grid voltage with the expenditure of an inappreciable amount of power in the grid circuit.

When the grid becomes positive with respect to the cathode, it can, and does, collect electrons so that an appreciable electron current may flow in the grid circuit.

The electrons flowing from the cathode to the anode must pass through the openings in the grid structure to get to the plate. Some of the electrons in this stream are intercepted by the grid wires and flow into the grid circuit. This current is determined by the area of the grid and by the grid and anode voltages. It is usually large enough so that it must be considered in the operation of the tube circuit.

The current collected by the grid causes power loss at the grid just as it does at the anode and, consequently, care must be exercised during operation to prevent overheating the grid in those cases in which the grid sometimes becomes positive.

The grid input power is a factor which must be taken into account in circuit design.

The grid current characteristic is usually complicated by the occurrence of secondary emission. We have seen how each impinging electron may liberate several electrons and give a net current leaving the bombarded electrode. This effect occurs in the triode during part of the positive grid voltage region of the characteristics.

In a vacuum tube, secondary emission may occur when the grid is at a positive potential of a few hundred volts and the plate at a somewhat higher voltage. The effect of secondary emission is not noticed unless the plate has the

higher positive potential, for only then will the secondary electrons leave the grid and flow to the plate. This emission of electrons causes distortion of the grid-current characteristics in the following way: if the plate voltage be held at some positive value, and the grid voltage raised from zero, the grid current will rise until the number of secondary electrons leaving the grid becomes equal to the number of primary electrons entering the grid circuit. At this point, the grid current will level off and start to diminish. Then as the grid voltage approaches the anode voltage, the secondary electrons have more difficulty in leaving the grid, and the grid-current curve will again reverse its direction and start to rise. As a result, the grid-current curve is often distorted badly.

This distorted characteristic contains a region of negative slope, and throughout this region, the associated circuit will behave as if there were a negative resistance in the circuit. In this way, secondary emission may cause unwanted or parasitic oscillations in certain types of circuits.

The equations which have been derived for the triode do not hold for the entire range of static characteristics. The reasons for departure are that the value of μ decreases slightly for low values of voltage and the exponent decreases at high currents. In addition, the equation does not show the saturation effect due to the limited amount of emission.

The greatest difficulty is that the space-charge equation gives the value of current leaving the cathode but tells nothing about its distribution. When the grid is negative, all the current goes to the anode, and the calculated values agree well with the measured values. However, for positive values of grid voltage, the calculated values give the sum of grid and anode currents rather than the anode current alone.

The performance of a triode as a circuit element can be predicted in certain cases by the use of three parameters calculated from the static characteristics. These parameters are:

- | | |
|------------------------------------------|-------|
| 1. Amplification constant | μ |
| 2. Grid-plate transconductance | g_m |
| 3. Plate resistance | r_p |

These three factors are related by the simple equation:

$$r_p \times g_m = \mu.$$

The amplification factor, transconductance, and plate resistance of a triode depend on the dimensions of the tube, such as the spacing between cathode, grid, and anode, the diameter of the grid wires, the spacing of the grid wires, the electrode area, and the electrode potentials.

The amplification factor can be calculated from known formulas,³ and the information obtained in this way may be used for preliminary tube design. After the static characteristics have been measured, it can be calculated best from a constant-anode-current plot. It is a measure of the relative influence of plate and grid voltages on the plate current and is expressed as the ratio of the change of plate voltage to the change in grid voltage which is required to maintain constant plate current. The amplification factor is the negative reciprocal of the slope of the constant-current curves and, referring to Fig. 24, is numerically equal to:

$$\mu = \frac{\Delta E_p}{\Delta E_g} = \frac{E_{p2} - E_{p1}}{E_{g2} - E_{g1}}.$$

The grid-plate transconductance is the rate at which the plate current changes with grid voltage. Numerically, it is the slope of the transfer characteristics and is expressed in terms of microamperes per volt or micromhos. The plate resistance is the reciprocal of the slope of the plate characteristics. Its units are volts per ampere, and it is expressed in ohms. This last term is sometimes called the a-c plate resistance. It measures simply the plate-voltage change per ampere and is dimensionally a resistance, but it should not be confused with the commonly accepted idea of resistance. The difference lies in the volt-ampere characteristic of the device. The volt-ampere characteristic of a

piece of wire is a straight line, and the resistance of the wire is found by dividing the voltage by the current. This gives the reciprocal of the slope of its volt-ampere characteristic. The number of watts lost in the wire in the form of heat is equal to EI or to I^2R . In the vacuum tube, however, the volt-ampere characteristic is not linear, and the slope of the characteristic, which is the reciprocal of the plate resistance, is not constant but varies with the plate current. In this case, the number of watts lost in heat is equal to $E_p I_p$, but is not equal to $I_p^2 r_p$. The plate voltage divided by plate current also defines a form of plate resistance which is of considerable interest in power applications. This resistance is a true measure of the anode power loss. These two resistances should not be confused. Ordinarily, the term plate resistance means the reciprocal of the slope of the plate characteristic curves and not the plate voltage divided by plate current.

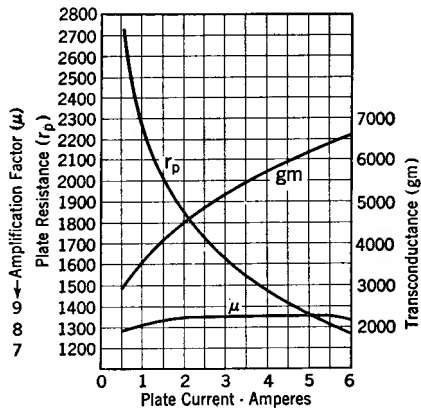

FIG. 27. Curves showing the variation of plate resistance, amplification factor, and transconductance with plate current.

The amplification factor is constant except for small values of plate current, while the plate resistance and the transconductance vary with the plate current. Consequently, values of plate resistance and transconductance are meaningless unless the corresponding voltages or currents are also given. The variation of these parameters with current in a typical instance is shown by Fig. 27.

All three of these factors are of use in certain types of vacuum-tube design work, but none of them are universally useful. As a general rule, the plate resistance, amplification factor, and transconductance can be used to predict

the performance of vacuum-tube circuits when the voltage variations are of the order of a few per cent of the applied voltage. For power applications, the voltage variations are large and the plate resistance and transconductance are not constant and are not useful in predicting tube performance except in very special cases. When the voltage variations are comparable with the applied voltage, accurate forecasts of tube performance can be made only by direct calculation from the tube characteristics. The actual use of the

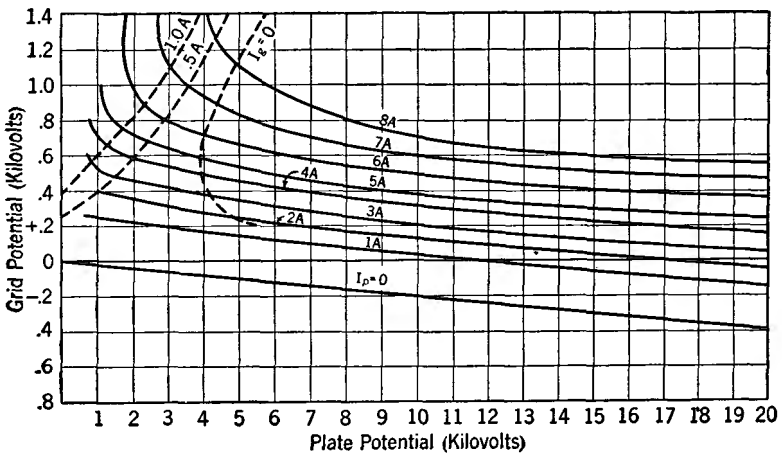

FIG. 28. Constant current curves for a high-vacuum tube. The tube with which these data were taken is the same as the one used for Fig. 24 with the exception of the μ which is higher.

static characteristics will be discussed in greater detail when we consider the application of the triode.

For comparison another set of constant-current characteristics is shown in Fig. 28. The tube which gave these characteristics has the same dimensions as the tube used for Fig. 23 with the single exception of the pitch of the grid winding. In this case, the turns are spaced closer together to give more shielding and, therefore, a larger amplification factor.

29. Double-grid tubes.^{4, 5} In the course of the development of triodes and their circuits, it soon became apparent

that additional grids could be added to give altered characteristics which would be of great benefit in certain applications.

A second grid is very often added to the triode to form a four-electrode tube or tetrode. In general, the second grid may be added for one of two reasons. Sometimes a grid may be added between the original grid and the cathode. A positive potential applied to this grid will increase the electric field at the cathode and thereby increase the transconductance and decrease the plate resistance. In use, this grid is maintained at a constant positive potential and, since it serves to decrease the space-charge effect, is called a space-charge grid. The original triode grid remains the primary source of current control and, hence, is called the control grid. The use of a second grid for a space-charge grid is not common practice.

One of the most important uses of high-vacuum tubes is the amplification of high- or radio-frequency voltages. Satisfactory performance of such an amplifier requires that the output or load voltage be completely controlled by a smaller voltage of the same frequency applied to the grid. The input or grid voltage is said to be amplified because it controls the frequency and amplitude of a much larger voltage in the load circuit. Triodes are inherently unsatisfactory for this service because of the electrostatic capacity between the grid and plate electrodes. This capacity couples the output circuit to the input circuit in such a way that some of the output voltage is impressed on the grid circuit. Then the output is not controlled completely by the primary excitation of the grid circuit. The reaction of the plate circuit on the grid circuit — or feedback as it is often called — can cause the circuit to generate self-excited oscillations at the fundamental or some other frequency. Parasitic oscillations render the amplifier completely useless for its original purpose and sometimes become severe enough in high-power amplifiers to destroy the tubes or some of the associated apparatus.

The triode can be relieved of this limitation to a very large extent by the insertion of a second grid between the control grid and plate. In this case, the grid is made of fine mesh to have a large electrostatic screening effect. Since it screens the anode very effectively, the anode voltage has very little effect at the cathode, and the plate current is controlled almost entirely by the control grid and screen-grid voltage. Such a tube will have a very high value of μ .

Furthermore, by providing a low-impedance path for high-frequency currents from this grid to the cathode, the grid and plate circuits can be very largely isolated from each other. Capacity current from the output circuit is diverted to the cathode and has little or no effect on the grid voltage.

This type of tube is a tetrode but is commonly called a screen-grid tube, and a grid inserted for the purpose we have just discussed is called a screen grid or simply a screen.

The screen-grid tube is characterized by a high amplification factor, high control-grid-to-plate transconductance, and a very high plate resistance. As may be expected, the plate voltage has only a slight effect on the plate current, except at voltages less than the screen voltage.

Since the screen is always maintained at a fairly high positive potential with respect to the cathode, conditions are favorable for secondary emission from the anode to the screen whenever the plate voltage falls below the screen voltage. This effect occurs in all screen-grid tubes and results in bad distortion of the volt-ampere characteristics at low plate voltages.

For this type of tube there will be two important transfer characteristics, one showing the effect which the control-grid voltage has on the plate current and the other showing the screen-grid-voltage effect. These two transfer characteristics are illustrated by Figs. 29 and 30. The amplification factor and the control-grid-to-plate transconductance can be calculated from Fig. 29.

The plate characteristic for the same tube is given by Fig. 31.

The distortion in the curves at plate voltages below the screen voltage is due to the secondary emission of electrons

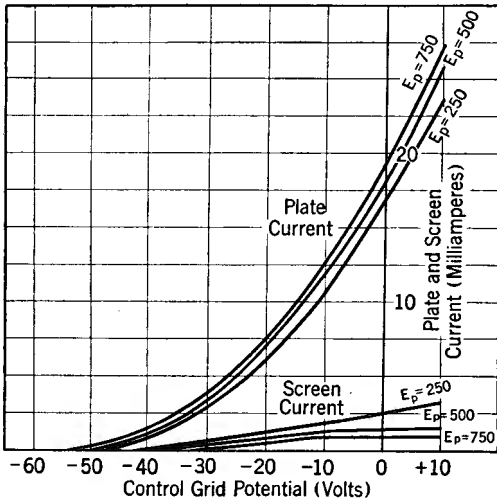

FIG. 29. Transfer characteristic of a screen-grid tube showing the effect of the control-grid voltage.

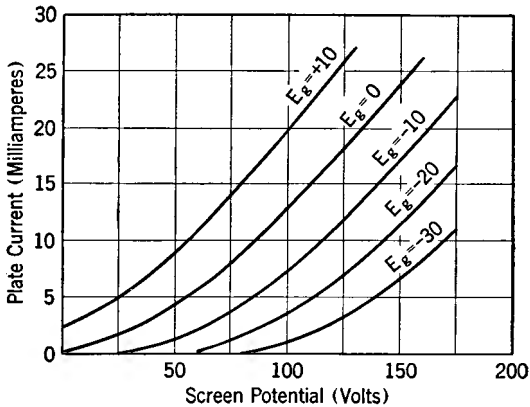

FIG. 30. Transfer characteristic of a screen-grid tube showing the effect of the screen voltage.

from the plate. This secondary emission of electrons takes place to some extent even at high plate voltages, but the electrons so emitted cannot leave the plate unless there is

some more positive electrode to serve as a collector. This latter condition is fulfilled when the anode voltage becomes less positive than the screen voltage. In this particular case, the anode can give off secondary electrons to the screen whenever the anode voltage becomes less than 125 volts. In this region, the screen-current characteristic is

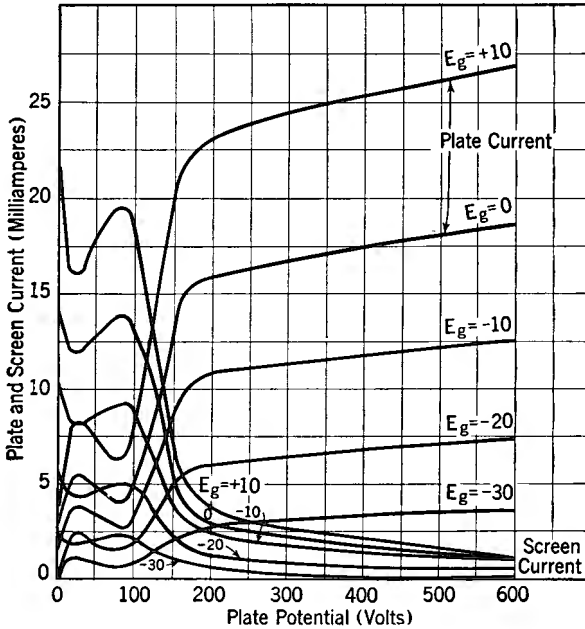
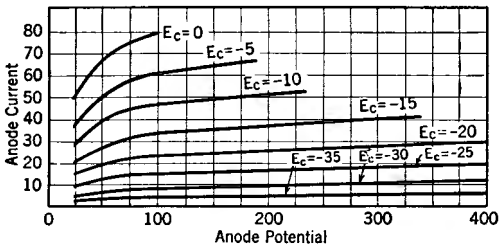

FIG. 31. The plate characteristic of a screen-grid tube. Note the distortion caused by secondary emission from the plate.

the exact opposite of the plate-current characteristic. The reason is that the number of electrons per second reaching the neighborhood of the screen is limited by space charge and is not greatly affected by changes of plate voltage. With a fixed amount of current at the disposal of the screen grid and plate, changing the plate voltage should simply bring about a continuous redistribution of the amount of current reaching the plate and screen. As a result, the amount of current taken by the plate is lost by the screen.

The continuity of this transition is destroyed by secondary emission.

30. Triple-grid tubes. Triple-grid tubes, or pentodes as they are called, are an outgrowth of the tetrode. The pentode is simply a screen-grid tube with a third grid added between the screen grid and plate to prevent the flow of secondary emission from plate to screen. This grid, which is termed a suppressor grid, is a wide-mesh grid and has little influence on the main current flow to the anode because the electrons which constitute the main plate current have been accelerated to a high velocity before they reach the suppressor grid. The action of the suppressor grid on second-



By permission of the R. C. A. Manufacturing Co., Harrison, N. J.

FIG. 32. The plate characteristic of a pentode. Compare these curves with those of Fig. 31.

ary electrons from the plate becomes clearer if we consider the plate to be a cathode and the screen an anode. The voltage accelerating the secondary electrons away from the anode is, then, the difference between screen and anode voltages. The suppressor grid is ordinarily designed to have a value of amplification factor which will cut off practically all the flow of secondary electrons with the suppressor grid at zero potential.

By eliminating the distorting effect of secondary emission from the anode, the tetrode characteristics are smoothed out. This is illustrated by Fig. 32, the plate characteristic of a commonly used pentode.

The suppressor grid is often connected directly to the cathode inside the tube, but in some cases, a lead is brought

out to a base pin, and the suppressor may then be connected to the cathode externally or used as an additional control electrode.

The improved plate characteristic of the pentode makes the tube more valuable as an amplifier of low-frequency voltages such as are present in the transmission of voice or music. It has also come into common use as a radio-frequency amplifier.

31. Internal-grid tubes. All the tubes considered so far are controlled by the electrostatic influence of a grid interposed between the cathode and anode.

One disadvantage of this construction is that the maximum current can flow to the anode only when the grid potential is made equal to or greater than the normal space potential. By normal space potential, we mean the potential at the point in the tube occupied by the grid due to the anode potential in the absence of the grid. In other words, with no grid in the tube, the space potential increases continually from cathode to anode — as shown by curve (C), Fig. 23 — so that the point between the two electrodes which the grid is to occupy normally should be at a positive potential. A grid at this point will reduce the current flow unless its potential is raised to or above the normal point.

We know the grid can be raised to this normal potential only at the expense of loss of current to the grid, with consequent grid heating, characteristic distortion, and the need for a driver circuit capable of supplying the grid power.

Internal-grid tubes are made with the filament between the grid and anode as shown in Fig. 33. Between the filaments the space potential is very near the cathode potential, so that, with the grid at zero or cathode potential, the current flow is not impeded. When this electrode, which is usually a solid metal sheet or cylinder, is made negative, it reduces the space potential throughout the interelectrode space and controls the space current in the same way as the more usual grid. Although there will be a small increase in current to the plate for low values of positive grid voltage,

the gain is small. At zero grid potential, the plate current is practically equal to the current through a similar tube with a conventional grid raised to normal space potential.

Clearly, the plate characteristics are confined to the negative grid region, and the disturbing effects of grid current are eliminated.

One disadvantage of this type of tube is that the amplification factor is low, usually slightly less than unity. The tube therefore requires large values of bias and excitation voltage. This disadvantage is largely counteracted by the low plate resistance and the absence of grid current. The μ may, of course, be increased by adding a screen grid.

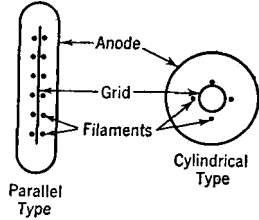

FIG. 33. Electrode arrangement in two types of internal-grid tubes.

The plate characteristic of a typical internal-grid tube is shown in Fig. 34. Because of its low plate resistance, large plate current variations can be obtained with the

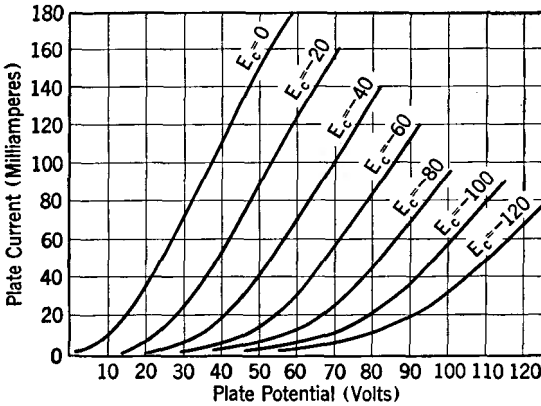

FIG. 34. Plate characteristic of an internal-grid tube.

expenditure of little or no power in the grid circuit. This type of tube is very useful for certain types of relay work, oscillograph amplifiers, and speech-frequency amplifiers.

In addition to the tetrode and pentode, there are a few

other special types of multi-grid tubes designed for specific service. No matter how many grids there are, however, the same fundamental conceptions hold true. The amount of current leaving the cathode is determined by the value of electric field at its surface, and this electric field is the composite field due to all the electrode voltages in the tube. The distribution of the space current to the various electrodes depends on their areas and the electric field in their neighborhood. For this reason, the current to any electrode is seldom a single-valued function of its own voltage, but instead is partly controlled by the potentials of the neighboring electrodes. Consequently, the volt-ampere characteristic of each electrode must be a family of curves to show the interaction of all the potentials involved.

The equations derived for the triode can be extended to include the tetrode and pentode, but the resultant formulas are clumsy and awkward to use.

The plate or transfer characteristics are used for circuit design purposes because they are much more convenient and because the equations become less useful as the number of grids increases.

32. Magnetic control.^{6,7} Another method of controlling electron space currents is afforded by the use of a magnetic field. Magnetically controlled tubes, in general, are of two types. Both consist of a cylindrical anode and an axial filament. One is controlled by means of a magnetic field applied externally to the tube in such a way that the magnetic lines of force pass through the tube parallel to the filament.

In the other type of magnetically controlled tube, the magnetic field is supplied by the current flowing through a single heavy filament placed in the axis of a cylindrical anode.

These two tubes function by virtue of the characteristic motion of electrons in a combined electrostatic and magnetic field. A moving electron acted upon by a magnetic field will be deflected from its original path and move along

a new path which is perpendicular to the original path and to the lines of magnetic force.

In the first type of tube, the electrons move radially outward from the filament toward the anode. During the outward journey, they are acted upon continually by a magnetic field parallel to the filament. The combined forces cause the electron to travel in a curved path lying in a plane perpendicular to the axis of the anode.

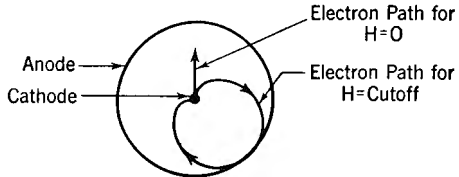

FIG. 35. Electron paths in a cylindrical, high-vacuum diode provided with a magnetic field parallel to the tube axis.

The path followed by an electron is shown in Fig. 35. As the magnetic field is increased, the paths become more and more curved until it becomes

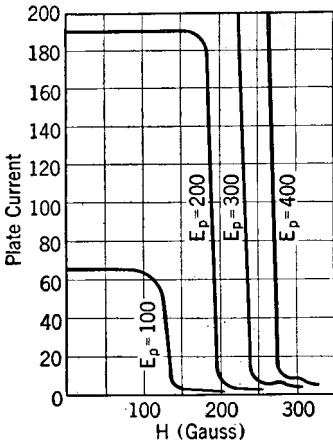

FIG. 36. The cut-off characteristic of a magnetically controlled tube of the type shown in Fig. 35.

possible for an electron to flow out from the cathode along a path which is curved so much that the electron misses the anode and returns to the cathode. The electron velocities are nearly equal, and the critical curvature occurs for practically all electrons at the same value of magnetic field density. At this critical value of magnetic field, the plate current falls abruptly almost to zero. Fig. 36 shows the type of control characteristic displayed by a typical tube. We see that magnetic field densities less than

cut-off have no effect on the plate current, but that the current does fall abruptly to a very low value when the field strength exceeds the critical value. The curve at the cut-off point is very steep but not discontinuous. The steep charac-

teristic is found only when the cathode, anode, and magnetic field are accurately co-axial. The presence of gas in the tube will cause the current to rise slightly before cut-off and may prevent cut-off entirely.

The relation between plate voltage, anode radius, and magnetic field density at cut-off is:

$$H = \frac{6.72}{r} \sqrt{E_p}$$

where

H is the flux density, at cut-off, in gauss.

r is the anode radius in centimeters.

E_p is the anode voltage.

The action of the axially controlled tube is similar except the paths of the electrons lie in a plane which also contains the filament of the tube. This tube is handicapped by the fact that the current which supplies the controlling magnetic field is also the filament-heating current. The variations of this current are limited not only by the magnetic field requirements but also by filament burn-out as a maximum and electron emission as a minimum. The relation between plate current and voltage has the same abrupt cut-off feature in both types of tubes. The dimensions, critical voltage, and current at cut-off are related according to the following equation:

$$E_p = 0.01876 I^2 \left(\log_{10} \frac{R}{r} \right)^2$$

where

E_p is the critical plate voltage.

I is the filament current.

R, r are radii of anode and cathode, respectively.

Experiments show that both these equations are very accurate. Neither type of tube is used extensively although the tube with separate field has many potential applications. Magnetically controlled tubes such as we have discussed and certain variations of these tubes are useful for the generation

of alternating voltages of extremely high frequencies.⁸ They may also be used in relays and in exploring instruments for determining the strength and direction of magnetic fields. For example, they may be used to study the shape of the field distribution around a coil or conductor. If the plate voltage be adjusted so that the tube is nearly cut-off for the magnetic field to be studied, then moving the tube around in space will give a minimum value of plate current only when the axis of the tube is parallel to the magnetic lines of force going through the tube. In this way, the direction of a magnetic field may be found and plotted on a chart. The actual field strength may be calculated from the equation for cut-off once the critical voltage is known.

BIBLIOGRAPHY

1. Electron Tubes and Their Applications, J. H. MORECROFT, John Wiley & Sons, Inc., 1935.
2. Theory of Thermionic Vacuum Tubes, E. L. CHAFEE, McGraw-Hill Book Co., 1933.
3. Amplification Constant for Three-Element Tubes, F. B. VOGDES and F. R. ELDER, *Physical Review*, December, 1924.
4. Some Characteristics and Applications of Four-Electrode Tubes, J. C. WARNER, *Proceedings Institute Radio Engineers*, April, 1928.
5. Four-Element Valve Characteristics, D. C. PRINCE, *Proceedings Institute Radio Engineers*, June, 1928.
6. The Magnetron, A. W. HULL, *Journal American Institute Electrical Engineers*, September, 1921.
7. The Motion of Electrons between Co-axial Cylinders under the Influence of Current along the Axis, A. W. HULL, *Physical Review*, May, 1925.
8. Investigation of the Magnetron Short-Wave Oscillator, E. C. S. MEGAW, *Journal Institute Electrical Engineers (English)*, April, 1933.

CHAPTER VI

TRIODE AND MULTI-GRID-TUBE APPLICATIONS

33. Dynamic characteristics.^{1, 2} It has been shown that a small change in the grid voltage of a triode will produce a change in plate current corresponding to a large change in plate voltage. Because of this fact, it is possible to increase the plate current in a vacuum tube by increasing the grid voltage in the positive direction even though the plate voltage be decreasing. It is true that the increase in plate current will be smaller than if the plate voltage were held constant, but an increase in plate current of some magnitude is nearly always possible provided the current does not become emission-limited or the plate voltage become so small that the plate current is not affected by grid voltage. This property of a vacuum tube gives it its ability to act as an amplifier.

In practice, this amplifying effect can be automatically produced by the use of a resistance, R , in series with the plate of the vacuum tube. Suppose that such an electrical set-up has been made and the grid has a negative, static, or bias voltage applied to it such that the plate current is just zero for the applied plate voltage E_b . Then, since no current is flowing in the circuit, there will be no voltage loss in the series resistor, and the full voltage E_b will be found at the plate of the tube. If now a small voltage E_g , which is to be amplified, be added to the existing grid-bias voltage E_c with such polarity that it makes the grid voltage less negative, some plate current will flow. This plate current will cause a voltage loss, in the series resistor in the plate circuit, which will be equal to $i_p \times R$. The plate voltage now is no longer E_b but $E_b - (i_p \times R)$. Because the change in grid voltage has more effect on i_p than an equal change of plate voltage, it is possible for the loss voltage $i_p R$ to be much larger than

the grid-voltage change E_g . Therefore, a large voltage change in the plate circuit has been produced with a small voltage change in the grid circuit, and it is said that the voltage applied to the grid has been amplified.

This is the basic principle upon which all amplifiers work. However, many other considerations must be taken into account, and they will now be explained.

Ordinarily, the resistor referred to in the previous paragraph is spoken of as the load resistor. The vacuum-tube load need not be a resistor, however; it may be an inductance or capacitance or any combination of these three.

Suppose that the vacuum tube is using a resistance load. The relation between current and voltage in the tube will now be something quite different from the plate characteristic or the transfer characteristic, because for each of these characteristics curves either the plate voltage or the grid voltage was held constant. No one of these curves will represent the conditions which exist when there is a load resistor in the plate circuit, for, then, all the voltages as well as the plate current vary. With a resistor in the plate circuit, the relation between the plate voltage and plate current must be a direct proportionality, because any change in plate current will produce a proportional change in the resistor voltage, and this voltage subtracted from the constant supply voltage must leave for the actual plate voltage an amount which is always directly proportional to the plate current. Consequently, the curve drawn as a plate characteristic — which represents the relation between plate current and plate voltage — will be a straight line. However, because of the influence of the grid, the plate current can be made very large and the plate voltage correspondingly small. Thus, there arises the condition that the current through the device is most when the plate voltage is least.

If now the straight line giving the plate current in terms of plate voltage is drawn, it will be found to have a negative slope. This line has a slope numerically equal to the reciprocal of the load resistance in ohms. Such a line is known

as the dynamic characteristic of the tube. The lines *AB* and *CD*, Fig. 24, are the dynamic characteristics for two modes of operation which are to be discussed in some detail. When the dynamic characteristic has a negative slope, the device exhibiting this characteristic is said to have a negative resistance characteristic. The value of the dynamic characteristic depends not only on the tube but also on the value of the load resistance and the voltages selected. It is the characteristic of the tube when working into a load in contrast to the static characteristic which represents the tube when idle, i.e., no load. The dynamic characteristic can be predetermined from the static characteristic if the circuit constants and voltages are known.

If the static characteristics of the tube were exactly parallel everywhere, the dynamic characteristic for a resistance load would always be very nearly a straight line. However, at the lower plate currents, the static characteristics change curvature rapidly, and if the dynamic characteristic be extended into this region, the relation between grid voltage and load voltage will not be linear. The dynamic characteristic for a reactive load taken with direct current will be the same as the static characteristic, but, if alternating current be applied to the grid, the dynamic characteristic will be looped because the alternating components of load voltage and plate current are out of phase. Curvature of the dynamic characteristic is also caused by attempting to exceed the emission limit of the cathode or by making the grid become more and more positive. In the latter case, two effects occur. First, the tube will become saturated, that is, a point may be reached where further increases in grid voltage will no longer increase the plate current. Second, since the grid circuit usually contains some resistance, the flow of grid current will cause a voltage drop in the grid circuit which shifts the dynamic characteristic to lower plate-current values by changing the bias voltage. For distortionless amplification, all these effects must be avoided. In some other types of service, the

dynamic characteristic is intentionally curved to give high-efficiency operation.

Some of the foregoing actions are utilized in the vacuum-tube voltmeter, which may use the circuit shown in Fig. 37. With the set-up illustrated, very little emission current is needed, and, therefore, the filament may be operated at low voltage. This voltmeter is made ready for use by adjusting the grid voltage accurately to give zero plate current with

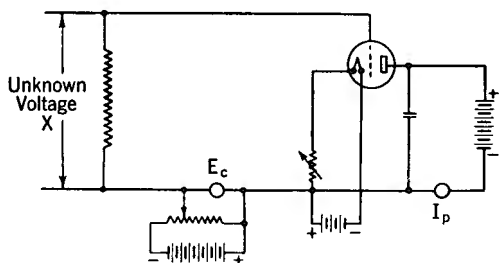

Fig. 37. The circuit for the slide-back voltmeter using a high-vacuum, three-electrode tube.

no voltage at X . In practice, this is not always feasible, but the current should be reduced to some low but conveniently read value, such as 0.5 microampere.

If now a d-c voltage be applied at X of such polarity that the grid becomes more positive, i_p will increase. This current i_p should now be reduced to its original value by increasing the negative bias voltage. Enough bias voltage in opposition to the unknown voltage has now been added to make the actual grid voltage return to its original value, as indicated by the return of the plate current to its original value. Evidently, then, the increase in grid-bias voltage must be equal to the unknown voltage. There is thus a voltage setting E_{c0} corresponding to zero voltage at X , and another voltage E_c when the unknown voltage is applied at X . In view of these considerations:

$$E_x = E_c - E_{c0}$$

If an unknown alternating voltage be applied at X , the

procedure for measurement is the same. In this case, however:

$$\text{Peak } E_{a-c} = E_c - E_{c0}$$

After the value E_{c0} is found and before E_x is applied, the grid-bias voltage should always be increased to its maximum value to avoid destroying the plate microammeter. If the battery voltages remain constant, E_{c0} will not vary and need not be repeated for every reading of E_x .

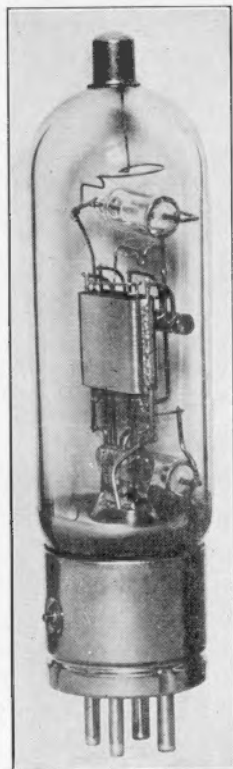

FIG. 38. A low-grid-current, high-vacuum tube.

This type of voltmeter is called the slide-back voltmeter and is useful for measuring voltage where insufficient power is available to operate an ordinary instrument. We know that the grid current will be only a fraction of a microampere, and, therefore, we are able to measure voltages in a circuit without disturbing that circuit by drawing current to actuate the voltmeter.

The tube shown in Fig. 38 is particularly useful when a measuring device with an extremely high input resistance is needed.³ This tube is a tetrode so designed that the grid current is a minimum. The tube can be used as a voltmeter or ammeter in circuits where the measuring instrument must add no load. The extremely low grid-current characteristic is obtained by using voltages below the ionization voltages of most gases, together with an exceptionally good evacuation. In addition, the control grid is mounted on special quartz insulators.

Using this tube, many circuits have been devised which are capable of measuring currents of the order of 10^{-16} ampere.⁴

Another special tube⁵ that is very useful in measurement work is shown in Fig. 39. It has been found that the steady plate current flowing in a vacuum tube is contaminated with random current effects due to a number of causes. Among these causes are charges on the glass walls and insulating members, space-charge fluctuation due to positive ions, and electrical leakage over the glass stem. Most of these random effects are found in the frequency band below 200 cycles, and consequently, if ordinary tubes are used for measurement purposes on direct current or low-frequency alternating current, a definite limit is put on the sensitivity of the measuring device.

Careful study has segregated the disturbance into the causes mentioned in the preceding paragraph, and this triode has been designed to reduce these effects to a minimum. The result has been accomplished by adopting a design which prevents the escape of electrons to surrounding insulating members and by the reduction of the residual gas content to a very low value.

Voltages of the order of 1.0 micro-volt can be measured, without interference from random effects, with an amplifier which uses one of these tubes in the first, or coupling, stage. For greater sensitivity, use is made of these tubes in the first two stages of the amplifier.

The vacuum-tube voltmeter is found to be very suitable for the measurement of small voltages in a high-resistance or low-regulation circuit, and for the measurement of radio-frequency voltage and current. In connection with an



FIG. 39. A three-electrode high-vacuum tube designed to have a minimum of undesired disturbances in the plate current flow; that is, a "low-noise" tube.

ondograph, it can be used to analyze complicated voltage or current wave forms.

34. Amplifiers.^{2, 6} Amplifiers are usually divided into the three following classes according to their specific functions:

1. Current amplifiers.
2. Voltage amplifiers.
3. Power amplifiers.

These three main divisions may be subdivided further according to less general characteristics. Fundamentally, all high-vacuum tubes are voltage-operated devices since the effect produced in the plate circuit by means of the grid voltage does not require a flow of current to or from the grid.

Current amplifiers, as such, are devices that convert small changes of grid voltage into large changes of plate current. They are characterized by an extremely low value of load resistance.

Voltage amplifiers are designed to give large output voltages for small grid voltages. This type of amplifier commonly uses a load of the order of 100,000 ohms or higher.

Power amplifiers use load resistances of only a few thousand ohms and are characterized by large grid- and plate-voltage variations and large plate-current variations.

The grid voltage for all vacuum-tube amplifiers is made up of two voltages. One of these is a constant voltage, called the bias voltage; and the other is the voltage to be amplified, called the exciting voltage or excitation. The bias voltage fixes the average value of grid potential. The actual instantaneous grid-cathode voltage is the algebraic sum of the bias and excitation voltages. Similarly, the total plate-circuit voltage is made up of two voltages. One of these is the constant plate-supply voltage and the other is the load voltage. The instantaneous anode-cathode voltage is the algebraic sum of the load voltage and supply voltage.

Usually the input voltage (exciting voltage) is some periodically changing voltage, such as a sinusoidal alternating voltage.

Vacuum tubes can be used with periodic voltages of any frequency up to about 6×10^8 cycles per second and in certain cases at higher frequencies. The frequency range below 16,000 cycles is usually called the audio-frequency range; above 16,000 cycles, the radio-frequency range. In the audio-frequency range, high-vacuum tubes serve principally as amplifiers of the alternating voltages used in the transmission of speech or music. Such amplifiers must amplify all frequencies in a rather wide band equally well, whereas amplifiers used in the radio-frequency range are usually required to operate over only a narrow frequency band. Because of the many differences in the circuit arrangement dictated by the frequency difference, all amplifiers which are used at low frequencies are commonly called audio-frequency amplifiers and higher-frequency amplifiers are called radio-frequency amplifiers. The load circuit for audio amplifiers may be a resistance or transformer or some combination of resistance and impedance which does not favor or discriminate markedly against any frequency. Radio-frequency amplifiers generally use a tuned circuit consisting of inductance and capacity in parallel. When such a circuit is tuned to the operating frequency, it acts like a high resistance for this one frequency and so may be used for a load circuit in much the same way as a true resistance.

A power amplifier operating with a tuned circuit for a load may be made to supply its own exciting voltage by returning part of the load voltage to the grid circuit with a suitable coupling device. With a properly adjusted circuit, such a device will convert power from a direct-current source to power in the form of alternating voltage and current at a frequency determined by the circuit constants. This device is called a self-excited oscillator or simply an oscillator and may be used as a power converter in the frequency bands previously mentioned.

Very often, the capacity that exists between the plate and grid of a vacuum tube will be sufficient to cause enough of the output voltage of an amplifier to return to the grid

circuit to make the circuit oscillate regardless of the voltage to be amplified. An amplifier which does this is useless, and corrective circuits must be added to neutralize the unwanted or feedback voltage. This effect is largely overcome with the screen-grid tube because the screen may be made to act as an electrostatic shield between the grid and plate and thus reduce the troublesome control-grid-to-plate capacity to a very small value. By using screen-grid tubes, voltage amplifiers can be built that will amplify the applied grid voltage about one hundred times.

In the foregoing explanation of the action of an amplifier, the grid voltage was considered to be made up of two parts: the bias voltage and the exciting voltage. For any value of applied plate voltage, there will be a value of negative grid voltage just sufficient to bring the plate current to zero.

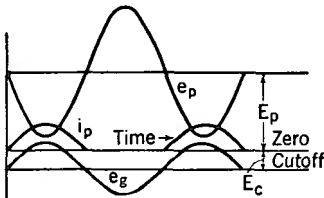

FIG. 40. The current and voltage relations in a high vacuum tube Class B amplifier.

This is called the cut-off point. Suppose a sinusoidal alternating voltage applied to the grid circuit with the tube biased just to cut-off. Then for every value of grid voltage on one-half cycle of exciting voltage, a proportional amount of plate current will flow and a voltage change will be produced in the plate circuit. However,

during the other half cycle, the tube will have more than enough voltage for cut-off and no current will flow. The current and voltage relations for the circuit will then be as represented in Fig. 40.

If the bias voltage be made greater than E_c , plate current will flow for less than one-half cycle; and if the bias is less than cut-off, plate current will flow for more than one-half cycle.

The properties of the amplifier are very largely determined by this choice of current period. Amplifier types are further subdivided into class A, B, or C, according to the length of the current period.

35. Class A amplifiers.^{2, 6, 7} These amplifiers are so biased and excited that plate current flows during the entire cycle, but the grid is never allowed to become positive with respect to the cathode. The output voltage is nearly an exact reproduction of the input voltage. The power amplification is high and the efficiency low. The grid bias is much less than cut-off as shown in Fig. 41.

Class A amplifiers are used to give high power amplification, medium power out-

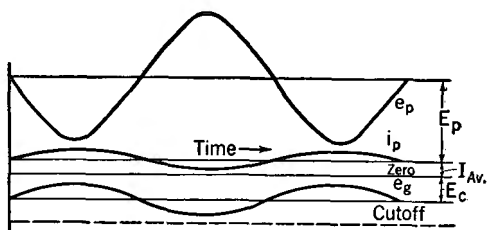

FIG. 41. The current and voltage relations in a high-vacuum tube used as a Class A amplifier.

put, and good reproduction of the wave shape of the exciting voltage. The dynamic characteristic is nearly linear, and the distortion is therefore small. They are used almost exclusively as audio-frequency amplifiers to supply power for telephone transmission, loud speakers for radio receivers, public address systems, and to supply the large amounts of audio-frequency power required for radio telephone transmission.

Class A voltage amplifiers are ordinarily used for the distortionless amplification of a small voltage. The plate load resistance or impedance is large compared to the plate resistance, and the plate current variation is small. Van der Bijl has shown that, under these conditions, the performance of the amplifier may be predicted by assuming a purely fictitious alternating voltage μe_g to be inserted in the plate circuit in series with the plate resistance and load resistance. Then the alternating component of current i_p in the plate circuit of the voltage amplifier can be written as:

$$i_p = \frac{\mu e_g}{r_p + R_1}$$

where r_p is the plate resistance of the tube, R_1 is the resistance

of the load, and e_g is the signal voltage applied to the grid. Then the output voltage is:

$$e_1 = \frac{R_1 \mu e_g}{R_1 + r_p}$$

and the voltage amplification is:

$$\frac{e_1}{e_g} = \frac{R_1 \mu}{R_1 + r_p}.$$

r_p is the plate resistance corresponding to the average tube voltages, i.e., plate potential equal to the supply voltage and grid potential equal to the bias voltage. The equation holds rather well for any type of amplifier tube. The effect of load resistance is shown by the theoretical curve, Fig. 44.

An amplifier of this type may be used in radio receivers and transmitters, phototube amplifiers, or in any other application requiring the distortionless amplification of a small voltage.

Class A power amplifiers operate with much lower values of plate load and larger current and voltage variations. *EF* of Fig. 25 shows a typical dynamic characteristic. Point *O*, which corresponds to the average value of plate voltage and current, is selected to give the highest power input to the tube without exceeding the rated anode power loss. The load resistance is chosen to give the highest power output without exceeding the allowable distortion. The slope of the dynamic characteristic is the negative reciprocal of the load resistance, and, so, lines may be drawn through the point *O* corresponding to any value of load resistance. The terminals of the dynamic characteristic give the peak values of the alternating component of plate voltage and current, and from these values, the power output and distortion may be calculated according to the following formulas:

$$\text{Power output} = \frac{(I_{\max} - I_{\min})(E_{\max} - E_{\min})}{8}.$$

$$\% \text{ Second harmonic distortion} = 50 \frac{I_{\max} + I_{\min} - 2I_b}{I_{\max} - I_{\min}}$$

Power input = $E_b I_b$.

I_b is the average value of plate current.

The proper operating conditions may be found by trying a number of different values for slope and, hence, load resistance. The best value of load resistance is usually about twice the plate resistance.

Briefly, the distinctive features of Class A service are low distortion, low efficiency, low power grid excitation. These features are obtained by biasing so that plate current flows all the time and by restricting the grid excitation to the negative part of the characteristics.

36. Class B amplifiers.^{2, 8, 9} In this type of amplifier, the plate current is allowed to flow for one-half cycle, and the grid is allowed to become positive. The grid driving circuit must, therefore, be capable of supplying power to the grid without changes in grid-voltage wave shape. The distortion is reduced by using a second tube arranged to supply a common load circuit with each alternate half cycle of plate current. In this way, the load receives a full cycle of alternating current although each tube supplies only one-half cycle.

The tube is biased almost to cut-off and excited by a large grid swing which forces the grid positive as far as distortion will permit.

The grid bias is usually made slightly less than cut-off to avoid the changed curvature in the low current part of the static characteristics.

The current-voltage relations are illustrated by Fig. 40 and by the typical dynamic characteristic CD of Fig. 24.

These relations are much the same whether the tube be used at high or low frequencies. The plate current is very nearly a half sine wave so that the ratio of peak to average is:

$$I_{\max} = \pi I_{\text{ave}}$$

Since the output voltage is also a sine wave with sinusoidal grid excitation, the following relations hold:

$$\text{Power output} = \frac{I_{\max} (E_{\max} - E_{\min})}{8}.$$

$$\text{Power input} = I_{\text{ave}} E_b = \frac{I_{\max} E_b}{\pi}.$$

These relations hold exactly if the wave shapes are sinusoidal, and if the plate current is biased exactly at cut-off. It is common practice to permit the flow of a small current, with bias only, to avoid distortion, and this residual current causes a small error unless taken into account.

Perhaps the greatest amount of distortion in the Class B amplifier is introduced by wave-shape distortion in the grid circuit due to grid current flow during part of the cycle. This distortion can be minimized by using low-resistance grid circuits fed from a source of excitation of sufficient capacity to supply the grid driving power without undue changes of wave shape.

This type of amplifier, as compared with the Class A amplifier, permits higher power output from the same size tube. Class B amplification is characterized by higher power output, lower power amplification, higher efficiency, and higher distortion.

Class B amplifiers are in common use as radio- and audio-frequency amplifiers.

37. Class C amplifiers.^{2, 8, 10, 11} Plate current flows for considerably less than a half cycle in the Class C amplifier. The distortion is large. The grid is driven positive to reduce the plate resistance to the lowest possible value regardless of plate-current wave-shape distortion. This mode of operation gives the greatest distortion, the highest power output, and the highest efficiency. Fig. 42 shows the current and voltage relations corresponding to the typical dynamic characteristic *AB* of Fig. 24. The Class C amplifier commonly uses a tuned load circuit and is employed only with exciting voltage of one frequency.

Class C operation is similar to Class B in many respects, but owing to the wave-shape distortion, straightforward calculation of the performance by means of simple formulas is rarely possible.

Accurate predetermination of Class C performance is best found by selecting a trial dynamic characteristic and calculating the average value and fundamental frequency component of the resultant plate-current wave shape. The

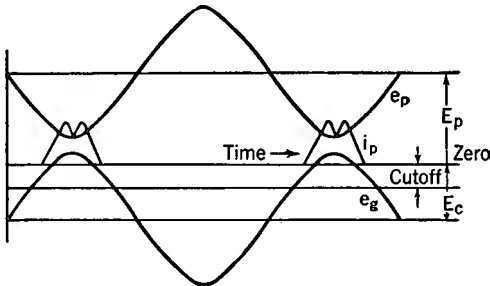

FIG. 42. The relation between plate current, plate voltage, and grid voltage for the Class C mode of operation.

load voltage and grid voltage, average input voltage, and grid bias are all determined by the chosen dynamic characteristic. These data taken directly from the tube characteristic permit an accurate forecast of the power output and input, load impedance, and other design features.

Fig. 43 shows the essential elements of the circuit arrangements used with the various modes of operation. The operation of the Class C self-excited oscillator is not self-evident because the tuned circuit plays such a large part.

The inductance L and the condenser C comprise a parallel electrical network. This network becomes resonant at some one frequency and when operated at the resonant frequency has several characteristics which make it useful for the plate load circuit of a vacuum tube. At resonance, this parallel network, or "tank" as it is commonly called, acts like a pure resistance having a value given by:

$$R_{\text{effective}} = \frac{L}{RC}$$

The circuit has the further property that energy may be supplied to it for a small fraction of a cycle and be stored during the charging period in the tank condenser. The

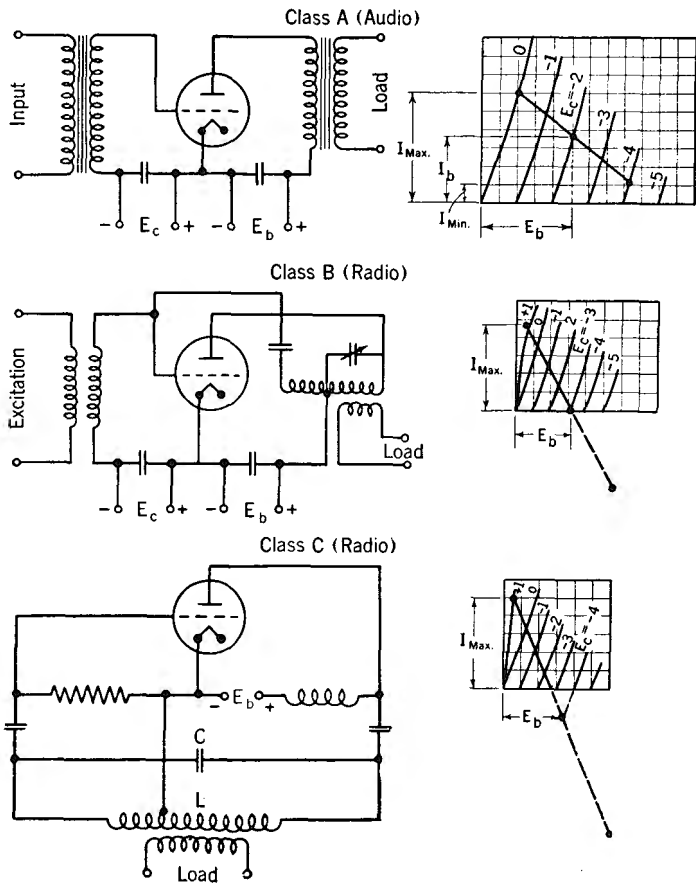

FIG. 43. Circuit elements for Class A, B, and C operation. The dynamic characteristics and the principal values of current and voltage are shown to the right.

stored energy will develop an alternating voltage between the condenser or inductance terminals provided the resistance is not too high. This alternating voltage will be nearly sinusoidal and will have a frequency given approximately

by the relation:

$$f = \frac{1}{2\pi\sqrt{LC}}$$

These properties are used in the vacuum-tube oscillator. Energy is supplied, in the form of plate-current pulses, to the tank circuit each cycle. This energy maintains an alternating voltage, having a frequency given by the foregoing formula, across the terminals of the tank circuit. So long as enough energy is stored during each cycle to supply all the circuit losses in that cycle, the oscillations will be maintained. During operation, a large alternating voltage is present between the plate and the filament, and a smaller

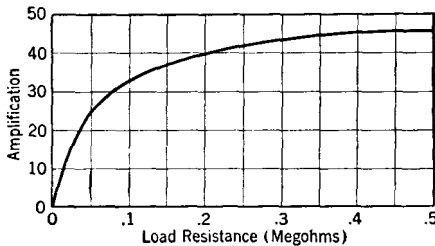

FIG. 44. The calculated gain in a high-vacuum tube amplifier for various load resistors. The tube for which this curve was calculated has a μ of 50 and a plate resistance of 50,000 ohms.

voltage, 180 degrees out of phase, between the grid and the filament. Consequently, even though the plate voltage decreases, the increasing grid voltage causes a large increase in plate current. This plate current must flow for only about one-quarter of the cycle, and the peak plate current must occur when the plate voltage is least, to obtain high efficiency.

When the grid goes positive, it, of course, draws electron current which is used to charge the grid blocking condenser and supply the grid-bias voltage automatically. The Class C amplifier is very similar to the Class C oscillator. In the amplifier, however, the grid alternating voltage is supplied from some lower-powered oscillator or amplifier. Since the frequency of the grid excitation is fixed by the preceding or driving stage, changing the constants of the amplifier tank

no longer changes the frequency, but instead presents a different load impedance to the tube. This circuit is brought into resonance usually by changing the tank condenser until the average plate current to the tube is minimum. At this point, the amplifier will operate with maximum efficiency unless extraneous oscillations occur.

Vacuum-tube oscillators or Class C oscillators, such as that described, are used as radio-frequency power converters for radio transmitters, testing purposes, induction furnaces, therapeutic treatments, and elevator leveling.

The power output of a radio-frequency oscillator or power amplifier may be radiated from an appropriate radiating system or antenna and caused to induce similar voltage variations in another, distant antenna.

At the receiving station, a vacuum tube may be used to detect these minute voltage fluctuations induced in the receiving antenna. Ordinarily, the load circuit of this detector tube is a high impedance (giving a resistance effect) or a resistance, so that small plate-current variations will cause large voltage changes in the load circuit. If the voltage induced by the distant transmitter be coupled to the grid of the detector tube, the plate current will change from the steady-state condition, provided the grid-bias voltage is not so large that no current can flow. This plate current will be made up of several components. One of these components will be a unidirectional current whose magnitude depends on the strength of the received signal. If a telephone receiver be connected in the plate circuit of this tube, nothing will be heard as long as the transmitter power remains constant. However, if the transmitter power be made to vary between fixed limits at a rapid rate, the radiated power and the received signal would vary in the same way; and the direct-current component in the plate current of the detector tube would no longer be constant but would vary between proportional limits at the same rate. The result would be a sound of the same pitch in the telephone receiver. If, for example, the transmitter

power were sinusoidally varied from maximum to minimum and back to maximum 256 times a second, the formerly constant component of plate current in the detector tube would have superimposed an alternating component of current having a frequency of 256 cycles per second and an amplitude of variation dependent on the amount of power variation in the transmitter. This alternating component of current would produce in the telephone receiver a musical note having a frequency of 256 cycles per second, i.e., middle C on the piano scale.

When the power output of a radio-frequency amplifier or of an oscillator is varied in this fashion, the power is said to be modulated. Modulation is accomplished by means of other vacuum tubes, and a tube used for modulating purposes is called a modulator tube or modulator. The modulator tube is simply a Class A or B amplifier capable of large amounts of power output.

The plate circuit of the modulator tube is so connected to the plate circuit of the power amplifier or oscillator that any variation of the output voltage of the modulator will cause a corresponding change in the plate voltage of the power amplifier or oscillator, and thereby change the radio-frequency power output in accordance with the plate-voltage variations of the modulator. The plate-voltage variations of the modulator tube are controlled by the signal voltage applied to the grid of the modulator. Since this type of amplifier will reproduce, with very little distortion, the wave shape and frequencies of the voltages applied to its grid, it follows that the voltage from a telephone transmitter may be made to change the radio-frequency power in an antenna system in accordance with the speech input to the telephone transmitter. At the receiving station, these power variations are translated into audible speech again by the rectifying action of the detector tube and the telephone receiver.

This is the fundamental arrangement of all radio broadcasting systems. There are at the transmitting station, first,

Class B or C radio-frequency power amplifiers to raise the power level of a small radio-frequency oscillator to the desired high value; second, Class A or B amplifiers to amplify the output of the microphones to a high power level; and, last, modulator tubes to modulate the radio-frequency power in accordance with the audio-frequency variations from the microphone.

At the receiving station, there are radio-frequency voltage amplifiers to magnify the received signal to a considerable voltage, and then a detector to translate the radio-frequency voltage variations into audible-frequency voltage variations. Following the detection, the audio-frequency voltages are usually amplified again by Class A amplifiers to any desired power level and supplied to the loud speaker.

The vacuum tube has found extensive application in this manner in radio service, but, nevertheless, it should not be regarded as a radio device. It is, instead, an electronic device which in one field of application has made modern radio transmission possible because of its inherent amplifying ability. Its extreme versatility is rapidly making it an invaluable tool in countless other applications as well.

Many hundreds of tubes are used in automatic train control systems which, by bringing information concerning the track ahead to the oncoming train, help make railroad transportation safe. For the past few years, the so-called fever machine^{12, 13} has attracted much attention. Research workers in the medical field have suspected for a long time that the fever accompanying a diseased condition is sometimes a corrective condition and would be helpful if it could be produced artificially and controlled. The possibility of doing this was demonstrated when several men working near a high-power, short-wave oscillator developed a fever. Subsequent tests proved that a patient placed between two large condenser plates could be given an entirely controllable fever with no permanent ill after-effects. The condenser plates are fed with alternating voltage — with a frequency of about 10,000 kilocycles — supplied by an ordinary Class C oscil-

lator. The temperature rise or fever is due to the heat generated in the patient's body by the high-frequency electrostatic field. This equipment promises to be a very valuable aid in the treatment of certain diseases.

High-vacuum tube amplifiers are also used in conjunction with phototubes to perform a vast number of automatic selection, control, and counting jobs in the manufacture of various articles.

We have seen how electron emission and space charge cooperate to give us the versatile high-vacuum tube, and now we must consider another great class of electron tubes in which the space-charge effect is modified by the addition of gas or vapor.

BIBLIOGRAPHY

1. *Electron Tubes and Their Applications*, J. H. MORECROFT, John Wiley & Sons, Inc., 1933.
2. *Radio Engineering*, F. E. TERMAN, McGraw-Hill Book Co., 1932.
3. *A Low Grid-Current Vacuum-Tube*, G. F. METCALF and B. J. THOMPSON, *Physical Review*, November, 1930.
4. *Amplification of Small Direct Currents*, L. A. DU BRIDGE, *Physical Review*, February, 1931.
5. *New Low-Noise Vacuum-Tube*, G. F. METCALF and T. M. DICKINSON, *Physics*, July, 1932.
6. *The Output Characteristics of Amplifier Tubes*, J. C. WARNER and A. V. LOUGHREN, *Proceedings Institute Radio Engineers*, December, 1926.
7. *Power Output Characteristics of the Pentode*, S. BALLANTINE and H. L. COBB, *Proceedings Institute Radio Engineers*, March, 1930.
8. *Operation of Valves as Class B and Class C Amplifiers*, *Proceedings Institute Radio Engineers*, March, 1932.
9. *Comparative Analysis of Water-Cooled Tubes as Class B Audio Amplifiers*, I. E. MOURMTSEFF and H. N. KOZANOWSKI, *Proceedings Institute Radio Engineers*, October, 1935.
10. *Analysis of the Operation of Vacuum Tubes as Class C Amplifiers*, I. E. MOURMTSEFF and H. N. KOZANOWSKI, *Proceedings Institute Radio Engineers*, July, 1935.
11. *Vacuum Tubes as Power Oscillators*, D. C. PRINCE, *Proceedings Institute Radio Engineers*, June, August, October, 1923.
12. *High Frequency Heating*, K. C. DEWALT, *Electronics*, November, 1932.
13. *Radiotherapy*, W. R. WHITNEY, *General Electric Review*, August, 1932.

CHAPTER VII

GAS- OR VAPOR-FILLED ELECTRON TUBES

38. Comparison with high-vacuum tubes.^{1, 2} It has been shown that in high-vacuum tubes the space-charge-limited current flow is determined entirely by the geometrical characteristics of the electrodes and the voltages applied to these electrodes. In the tubes to be considered now, the magnitude of the current flowing is not affected by relatively large changes in the shape and size of the electrodes.

This class of tubes comprises all the gas- or vapor-filled tubes. These tubes resemble the high-vacuum tubes in a general way inasmuch as they ordinarily use a hot cathode as a source of electrons, an anode to collect the electrons, and may have any number of control elements. In addition, however, all these tubes are filled to a low pressure with some inert gas such as argon or helium or with the vapor of some material such as mercury or cesium. It is this gas content which makes the great distinction between this class of tube and the high-vacuum tubes.

The conduction of electricity through gases includes a number of associated phenomena, such as corona, sparks, arcs, and glow discharges.^{11, 12} These phenomena are all related by their dependence on electron flow and ionization. They are distinguished, one from another, by the pressure and kind of gas and by the electron-emitting mechanism.

It is not necessary for our purpose to explore this entire field since we are primarily concerned with tubes using hot cathodes and a low pressure of some monatomic gas. The gases commonly used are argon or mercury vapor. If the gas be mercury vapor, the pressure is generally between 1.0 and 100 microns. With argon, the pressure is about 150 to 500 microns. Therefore, we need consider only the

conduction of electricity through gases at low pressures. This branch of the whole field has been the subject of intensive study by many workers who have brought to light a vast amount of experimental information upon which to base workable theories.

The difference in the gas- or vapor-filled tubes and the high-vacuum tubes may be clarified by the following summary:

The high-vacuum tube is characterized by:

1. Large cathode-to-anode voltage differences.
2. A high effective resistance to current flow.
3. The necessity for large voltage changes to obtain large current changes.
4. Medium efficiency of energy transfer.

The gas- or vapor-filled tube is characterized by:

1. Small cathode-to-anode voltage differences.
2. A low effective resistance to current flow.
3. Large current changes with practically constant voltage difference between anode and cathode.
4. High efficiency of energy transfer.

These points of difference are not obtained by design features but are the results of the fundamentally different method of current conduction through the tube. The current flow in the high-vacuum tube is controlled entirely by the electrostatic influence of the electrodes. This advantage is gained, as we have seen, only at the expense of high voltage and power losses. In the gas- or vapor-filled tubes, the view point is reversed. We wish to obtain the desired current flow with the least power loss and the lowest voltage drop. Space-charge, such as we found in the high-vacuum tubes, is unwanted and we make every effort to minimize it.

39. Formation of the arc. In the high-vacuum tube, the magnitude of the electron current flow is controlled by the distribution of potential in the space between the emitting and collecting electrodes when that space contains the electrons which make up the current flow. The presence

of these electrons decreases the potential in the space below the values which would exist if no charges were present. All these factors are effective in governing the amount of current flow in a way expressed quantitatively by the well-known space-charge equations.

Suppose now that a small amount of gas be admitted to the tube. The current-voltage characteristic would no longer follow the space-charge equation. The curve would be steeper; that is, the current would increase more rapidly with voltage than the space-charge equations predict. The addition of more gas would cause still greater departures from the high-vacuum characteristic. In addition, we would find the tube filled with a colored glow characteristic of the kind of gas admitted.³

In particular, suppose that one of the high-vacuum, two-electrode tubes had been filled with mercury vapor by distilling some mercury into the tube after the tube had been exhausted of other gases. If then a volt-ampere characteristic were taken on this tube, it would be found that

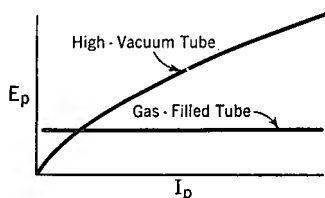

FIG. 45. Simplified curves to show the distinction between the volt-ampere characteristics of high-vacuum tubes and gas-filled tubes.

increasing the plate potential from zero to about 8.0 volts positive would cause a small current to flow to the anode. This current might be even less than if no vapor were present in the tube. However, the current through the tube would increase more rapidly as the voltage was raised until, at about 12 or 15 volts, the current would jump to a very large value. If

the cathode were capable of emitting large currents, it would be found that changing the plate load resistance would cause large variations in current with but little change in the voltage between the cathode and anode of the tube. The volt-ampere characteristic of such a tube and that of a high-vacuum tube are represented in Fig. 45 to show the main difference between this charac-

teristic of these tubes. The tube has changed its nature because of the positive ions formed by electrons colliding with gas atoms.

The ions are the loci of positive charges corresponding to the loss of one or more electrons from the atom. They tend to make every point in the interelectrode space more positive. If enough ions are present, not only can the original negative space charge due to the electrons be eliminated, but also a positive space charge can be substituted. The positive ions are very heavy and do not move rapidly. Therefore, they do not contribute much to the total current flow. They do permit, however, the flow of extremely large electron currents by altering the space potential. For example, Langmuir has shown that, for very low rates of ion production, one mercury ion generated at the anode will permit the flow of 229 additional electrons.⁴ Similarly, one argon ion will cause 102 more electrons to cross from cathode to anode.

The gas discharge is made up of three types of particles; the electrons, the neutral gas atoms, and the positive ions. Each of these three constituents has its own characteristics and each plays an important rôle in the conduction of the current from cathode to anode.

We have discussed the production and behavior of ions and atoms in a general way in an earlier chapter. Now, we must inquire into the part which they play in making our electron-tube family even more versatile.

The mechanism of the building-up of the gas discharge may be described briefly as follows: if a gas- or vapor-filled tube be connected to a circuit arranged to study the volt-ampere characteristic, no current can flow until plate voltage is applied.

When the circuit is closed — assuming the cathode to be raised to an emitting temperature — some electrons will leave the cathode and move toward the anode.

In the high-vacuum tube, these electrons follow a continuous path from the cathode to the anode. In the gas-

filled tube, however, the average length of uninterrupted motion is the length of the mean free path.

If the electric field strength in the space between electrodes is high enough to give the electrons an ionizing velocity, some of the collisions will result in the formation of positive ions and free electrons.

Owing to their much larger mass, the ions cannot flow across the interelectrode space as rapidly as can the electrons. The influence of each positive ion is exerted for a comparatively long time and, therefore, a few ions can neutralize the negative space-charge effect of hundreds of electrons. As the rate of ion generation increases with increasing voltage or gas pressure, the ions first counterbalance the negative space charge due to the electrons and then raise the space potential above normal by substituting a positive space charge. The positive space charge may be made so intense, and the space potential raised so much, that finally the potential gradient at the anode will be reduced to zero. As shown by Langmuir, any further increase in the number of ions generated will develop a potential maximum near the anode.^{4, 5}

However, the existence of a potential maximum means that there is a retarding potential which tends to prevent electron flow to the anode.

The electrons knocked out of the atoms when the ions are formed join the stream of electrons which come from the cathode. So long as there is no potential maximum, all of the electrons flow to the anode. If, however, the ion generation rate is high enough to form a potential maximum, only those electrons with sufficient energy can move against the retarding field and reach the anode. The low-speed electrons accumulate in the potential maximum. The trapped electrons add negative space charge which lowers the height of the potential maximum and, hence, the retarding field at the anode. The lower-potential barrier permits a larger electron flow to the anode and checks the accumulation in the potential maximum. This process of

self-adjustment continues until the number of electrons flowing into the potential maximum is exactly balanced by the number which escape to the anode.

The whole process can be summarized by saying that the transition from no current flow to the arc discharge is brought about by increasing the ion generation rate from zero to the value needed to produce a

potential maximum in space between the anode and cathode. The potential distribution changes progressively from that corresponding to a slight negative space charge to that of a more and more intense positive space charge until the potential maximum is formed. Further potential increases are prevented and equilibrium is established by the accumulation of electrons in excess of the number needed for current conduction. This mechanism gives rise to a potential distribution in the interelectrode space similar to that illustrated in Fig. 46.

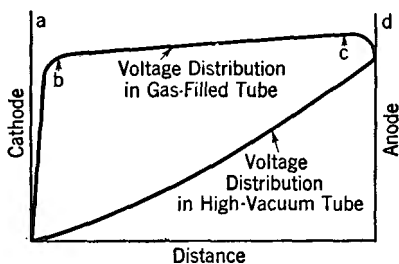

FIG. 46. Comparison of the voltage distribution in a high-vacuum tube and in a gas-filled tube.

Further potential increases are prevented and equilibrium is established by the accumulation of electrons in excess of the number needed for current conduction. This mechanism gives rise to a potential distribution in the interelectrode space similar to that illustrated in Fig. 46.

The conditions which must be fulfilled before the arc can start may be made clearer as follows. Consider a tube having a hot cathode and an anode and filled to a low pressure with some gas — say mercury vapor. An arc discharge will not be established between these two electrodes until enough ions are being generated to raise the potential of some point in the interelectrode space above anode potential. The number of ions required depends on the anode potential and electrode configuration but, obviously, for any one tube depends only on the anode potential since electrode shapes and sizes are fixed in manufacture. The number of ions produced by electron impacts obviously involves the number of electrons flowing from cathode to anode.

The electron current and the required positive-ion

density are related by the ionization probability^{6, 7, 8} which we discussed in an earlier chapter.

When we say that, for every anode voltage, there is a minimum required rate of ion production, we are at the same time fixing the minimum electron current flow needed to produce the ions. The value of electron current which will produce the required number of ions depends, of course, on the electrode configuration, the kind and pressure of the

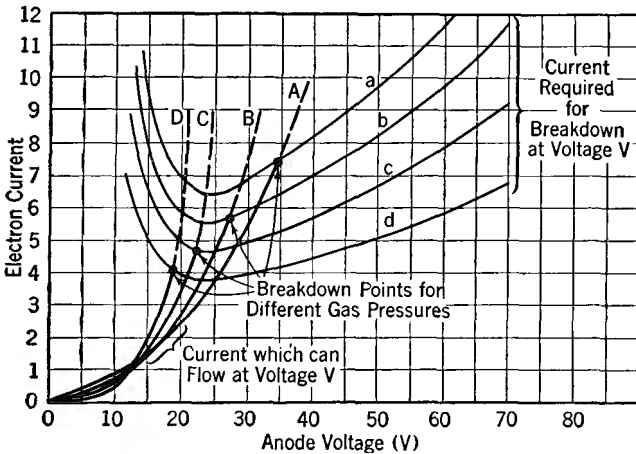

FIG. 47. The calculated current required for breakdown in a hypothetical case and the actual current flow. The intersections of the two sets of curves give the breakdown voltages for different gas pressures.

gas, and the accelerating voltage. In the tube we are considering, we can change only the gas pressure and voltage. The curves of Fig. 47 illustrate the relation between anode voltage, gas pressure, and electron current needed to start the arc discharge.

These curves are boundaries which mark the points where the arc can start. The arc will start, therefore, when the anode voltage is increased enough to make the actual current flow equal the boundary value. For example, curve (a) of Fig. 47 shows the current required and curve (A) gives the values of current which can flow. Both curves are for the same gas pressure. With anode voltages below about 35

volts, the electron current is not enough to produce the required ionization. Any anode voltage equal to or greater than the intersection point of the two curves will cause the arc to start. Curves *B-b*, *C-c*, and *D-d* show the effect of higher gas pressures.

Certain sections of the discharge behave quite differently and have been given distinguishing names. The regions of large potential change *ab* and *cd* in Fig. 46 are called "sheaths," and the region *bc* is called the "plasma." The plasma will be recognized as the flattened potential maximum.

The plasma is a region where the change in voltage in the cathode-anode direction is small and the number of ions is about the same as the number of electrons.

The sheaths are regions of high electric fields and are characterized by a preponderance of ions or electrons. In Fig. 46, the regions *ab* and *cd* have a voltage distribution which will accelerate positive ions out of the plasma to the anode and cathode, and are known as positive-ion sheaths.

40. The Plasma.^{2, 5, 9} The characteristics of the plasma and of the sheaths are so different that they can best be discussed separately.

The plasma is the main body of the arc and is a region of small electric fields. Theoretically, ions and electrons are present in about equal numbers. Three types of particles are present: neutral and excited gas molecules, ions, and electrons. The electrons in the plasma usually have a Maxwellian velocity distribution and behave like a gas, but with the added feature that this electron gas is influenced by electric and magnetic fields.

Of all the gases or vapors which might supply the ions, mercury vapor usually is the most satisfactory, because the mercury ion is heavy and is more effective for reducing electron space charge. Mercury vapor has a relatively low ionization potential and a high ionization probability. These factors contribute to high efficiency of current conduction. At ordinary pressures, if all other conditions re-

main the same, the density of gas atoms controls the number of collisions, and consequently, the number of ions, which an electron can make. We can therefore expect the characteristics of the discharge to depend on gas pressure.

In mercury-vapor-filled tubes, the vapor is supplied by evaporation from a small pool of mercury at the bottom of the tube. The vapor pressure, and therefore the atomic density, are controlled by the temperature of the coldest

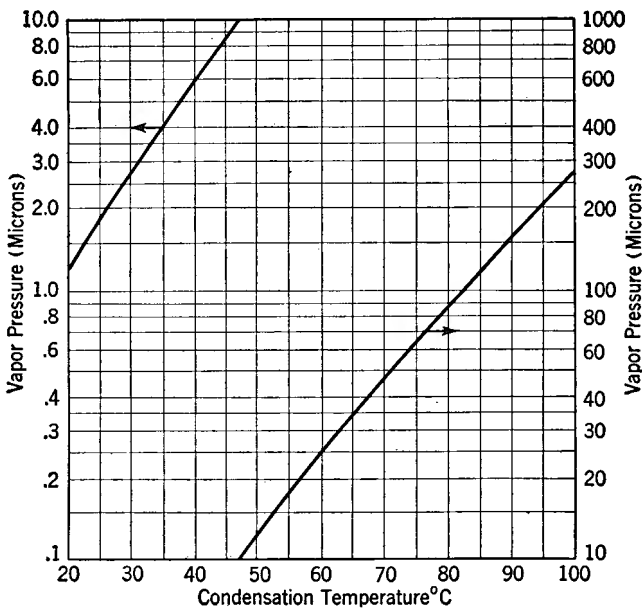

Data from International Critical Tables.

FIG. 48. The vapor pressure of mercury for various values of condensation temperature.

point (condensation point) in the tube. The relation between condensation temperature and vapor pressure is given in Fig. 48. The actual density of mercury atoms can be calculated with the equation relating density and pressure, given in Chapter II.

The fact that the atomic density is controlled by tube temperature is a slight disadvantage, and sometimes artificial temperature control must be provided.

If the tube be filled with some inert gas, such as argon, the temperature effect disappears. In this case, a definite amount of gas is put into the tube during manufacture, and, although the gas pressure changes with temperature according to the well-known gas laws, the number of atoms remains the same. This advantage is counteracted by the lower conductivity arising from the lower mass and ion productivity and the higher ionizing potential. Another, and more serious, disadvantage of the inert-gas filling is the removal of gas by the tube walls and electrodes. The gas is very slowly adsorbed, or cleaned up, by the tube walls and electrodes and causes a progressive lowering of gas pressure during the life of the tube. In extreme instances this will change the tube characteristics markedly and, in addition, render it unable to carry rated current.

The higher electrical conductivity afforded by mercury vapor so far outweighs the temperature disadvantage that it is used very extensively. Argon is widely used for low-current tubes and special-purpose tubes.

The permissible condensed mercury temperatures usually lie between 20° C and 80° C and are always given on the rating sheet supplied with the tube.

The cathode is surrounded by a positive-ion sheath⁴ which is the seat of most of the total voltage change through the tube. The electrons which leave the cathode are accelerated by the voltage drop in the cathode sheath and are projected into the plasma. They collide with gas molecules in the plasma and ionize some of them with the energy gained during acceleration in the cathode sheath.

In low-current discharges, most of the ions seem to be formed by single-stage ionization, i.e., ionization due to a single impact by an electron of sufficient velocity. As the current density increases, cumulative or multiple-stage ionization plays an increasingly important part. Many of the ions are produced by encounters between low-velocity electrons and atoms in excited states. Ionization of atoms in a metastable state seems particularly probable in view

of the relatively long time which this state may persist. For example, a mercury atom may be put into a metastable state by collision with an electron which has a velocity of 4.66 volts. A subsequent impact by a 5.74-volt electron can ionize the atom. Atoms may be put in an excited state by a number of processes.^{6, 7, 8} The most important seem to be excitation by collision and excitation by absorption of radiation. Energy radiated by an excited atom when it reverts to normal may be absorbed by a neighboring atom which is then raised to an excited state. It, in turn, re-radiates the energy after a short time; possibly, to nearby atom. In this way, the radiated energy is passed on from atom to atom until it finally escapes from the tube leaving in its wake a train of successive excitations. Thus, the

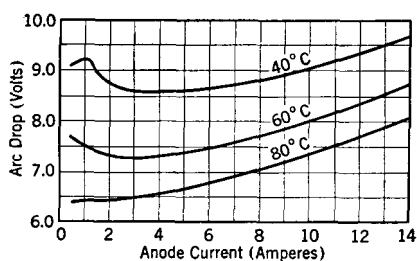

FIG. 49. The effect of load current and mercury temperature on the arc drop.

energy radiated from each excited atom gives rise to many opportunities for ionization by low-velocity impacts.

The usual result is that the voltage drop or arc drop between cathode and anode is somewhat higher for the lowest values of current than for somewhat higher values. This imparts a negative resistance character to the low-current end of the arc-drop curve as shown in Fig. 49.

The electrons in the plasma behave like a gas having a very high temperature and a random current density determined by this temperature. In addition, there is a small electric field in the plasma which causes a steady flow of electrons toward the anode. Electrons progress through the plasma by a series of random paths which, no matter how erratic, give an average flow in the direction of the anode. For every value of load current, there will be needed a definite electron current density at the anode equal to the load current divided by the anode area. If the random

current density at the surface of the anode is more than enough to supply the load current, the retarding voltage barrier cd builds up to repel the electrons which are not needed. The anode is then surrounded by a positive-ion sheath. If the load current is higher than can be supplied by the random current, there will be a positive drop at the anode to accelerate more electrons from the plasma. If the supply and demand are equal, there will be no voltage change at the anode, i.e., the anode and plasma will be at the same potential.

Variations in the anode drop with load current account for part of the total arc-drop change. Ions are continually being formed in the plasma. They cannot accumulate in unlimited numbers because of their own charge. Ion accumulation in any region raises the potential of that region and drives the ions out. This self-correcting ability gives the plasma a small electric field which accelerates ions outward to the walls of the tube and to the electrodes as fast as they are made.

The plasma is the seat of the glow which we see when the tube is working. The glow is light radiated by the excited atoms in the plasma and has a color which is a characteristic of the kind of gas.

The main function of the plasma is to supply a highly conducting path through the major part of the distance from cathode to anode.

41. Sheaths.^{1, 2} Fig. 50

shows the volt-ampere characteristic of an electrode immersed in a typical plasma. This curve shows that, when the electrode is made negative, electrons are repelled from it and positive ions collected.

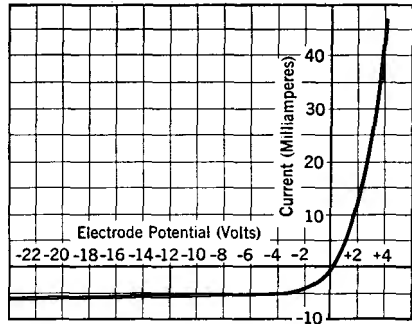

FIG. 50. Volt-ampere characteristic of an auxiliary electrode immersed in an arc discharge.

When the electrode is positive, ions are repelled and electrons collected. No sharp line of demarcation divides the electron current from the ion current because, as the curve shows, when the electrode is only slightly negative, some of the high-velocity electrons can move against the retarding field and reach the collector. In Fig. 50, this is noticeable at about -4 volts. As the collector potential approaches zero, more electrons can reach it, and the curve turns smoothly upwards.

For negative voltages greater than 4.0 volts, the current is almost entirely made up of positive ions which flow in from the plasma. Then, the collector is surrounded by a positive-ion sheath.

This sheath¹³ is a thin, well-defined region of high electric field containing almost no electrons. Immediately outside the sheath, that is, just within the plasma, the electric field is essentially zero. This is the potential condition which exists in the high-vacuum tube when it is conducting space-charge-limited current. The sheath edge acts like a cathode emitting charges of one sign to the collector within the sheath. Langmuir and Mott-Smith, who have made an extensive study of the properties of sheaths, show that the space-charge laws are applicable to the region inside the sheath. The sheath is usually so thin that it has essentially the same shape as the collector, and the proper space-charge relation can be selected from a knowledge of the shape of this collector. The space-charge equations need to be modified only by replacing the electron mass by the value of the mass of the gas atom.

The potential drop through the sheath is the difference between the collector potential and plasma potential.

The number of positive ions which can flow to the collector is limited to the number which cross the sheath edge from the plasma because of energy acquired in the plasma. Consequently, the ion current to the collector is almost completely independent of collector potential and is determined by the number of ions being generated within the plasma. This independence is shown by the left-hand part

of Fig. 50. Since the current flow through the sheath is determined by conditions within the plasma, the boundary conditions and the space-charge relations can be satisfied only by a change in sheath thickness with voltage or current. The result is that changes in collector voltage have very little effect on the positive ion current and cause simply a change in sheath thickness which is calculable from the appropriate space-charge equation.

For example, the area of the electrode used in Fig. 50 was about 38 square centimeters, and the saturation current density was, therefore, about 1.45×10^{-4} ampere per square centimeter. The sheath thickness in mercury vapor can be calculated from the relation:

$$I = 3.86 \times 10^{-9} \frac{V^{3/2}}{x^2}.$$

With -10 volts on the collector, about -20 volts with respect to the plasma, the calculated sheath thickness is 0.019 inch.

Since the whole potential difference between the plasma and the collector occurs in the sheath, the collector potential can have no influence outside the sheath. We may consider the sheath as a highly effective electrostatic shield which usually eliminates any effect of the electrode potential on the anode current. Special conditions, which we will examine later, permit the potential of an auxiliary electrode to exert some control over the arc current.

Electron sheaths have approximately the same properties provided there is no ionization within the sheath. The simple forms of space-charge equation are not as accurate for low potential differences because the effect of the large thermal velocities of the electrons is not included.

Positive-ion flow from the plasma to the surrounding electrodes and walls constitutes the chief loss of ions from the arc. Experiment has shown that recombination of electrons and ions in the arc is relatively rare, practically all recombination occurring at the surface of the electrodes or

tube walls. Although we speak of positive-ion currents to an electrode in a gas discharge, it must be remembered that the current flow in the external circuit of that electrode is not a flow of ions away from the collector, but rather a flow of electrons toward the electrode. Positive ions flow in from the space surrounding the electrode, recombine with electrons at the electrode surface, and re-evaporate as neutral gas molecules.

These sheaths cover every part of the tube, including the walls and all insulating materials. There can be no preponderance of charges of one kind arriving at the insulating parts of the tube, because practically no current can flow away. Consequently, the positive ions and electrons must arrive in equal numbers. The insulators, such as the glass walls, automatically acquire a potential, negative with respect to the plasma, such that the ions and electrons will arrive in substantially equal numbers and recombine at the surface into neutral gas atoms.

The cathode⁴ is surrounded by a positive-ion sheath since it is at a negative potential with respect to the plasma. The situation here is somewhat different because there is a flow of electrons out from the cathode as well as a flow of ions in from the sheath edge. If the available cathode emission is in excess of the current required in the load circuit, the electric field at the cathode as well as at the sheath edge must be zero. The cathode is surrounded by an electron sheath which in turn is surrounded by an ion sheath.

The potential distribution within this double sheath is determined by the relative numbers of electrons and ions. Ions flow into the sheath from the plasma and partly neutralize the electron space charge. The ion flow in from the plasma will increase until the electric field at the sheath edge is reduced to zero. Electrons flow in from the cathode and neutralize some of the positive-ion space charge. Equilibrium is reached when the electric fields at the cathode and at the sheath edge are reduced to zero, and the electron

and ion currents bear the following relation:

$$\frac{I_e}{I_p} = \sqrt{\frac{m_p}{m_e}}.$$

For mercury vapor, this ratio becomes:

$$\frac{I_e}{I_p} = 605$$

and for argon:

$$\frac{I_e}{I_p} = 271.$$

Since the electric field at the cathode is zero, the electron current is space-charge limited. An increase in load current demands an increase in ionization intensity in the plasma so that the above relation can still hold. The cathode voltage drop adjusts itself to give the electrons enough energy to produce the required ionization in the plasma. In general, the cathode drop varies inversely with ease of ion production. For example, high gas densities, heavy atoms, high ionization probabilities, and low ionization and resonance potentials all tend to reduce the cathode drop.

The above relations show that, for a given current density, the use of argon in place of mercury requires the formation of about 2.2 times as many ions. This fact coupled with the lower ionization probability accounts for the use of a higher gas pressure in argon-filled tubes. Experiments made by C. G. Found¹⁴ show that, if we try to draw a load current higher than the cathode emission, the double sheath disappears, and the ratio of ion and electron currents at the cathode is no longer proportional to the square root of their masses. In this event, the positive-ion sheath extends right up to the cathode surface, and the electric field at the cathode is raised. Calculations show that the electric field is enough to cause field emission from the cathode and permit the flow of a load current which exceeds the thermionic current.

The increased field is accompanied by an increased cathode drop and, consequently, a higher arc drop.

A. W. Hull has discussed a very important effect¹⁵ which permits the use of coated cathodes in gas discharges in spite of the continual positive-ion bombardment of the coating. Although bombardment by high-velocity positive ions will destroy a coated cathode in a very few minutes, the destructiveness decreases with ion velocity, and below 25 or 30 volts the ion bombardment has little or no effect. The destructive action begins fairly abruptly in this voltage range. The exact value — called the disintegration voltage — depends on the type of coating and the kind of gas. Fortunately, in some gases, the cathode drop required to give the proper ion production is only about 40 or 50 per cent of the disintegration voltage. A coated cathode used with these gases is not injured by the ions flowing to it through the cathode sheath.

These effects account for two of the most important precautions which must be observed when the tube is used. If full-load current be demanded from the tube before the cathode has reached the proper operating temperature, the emission may be too low and a high cathode drop will develop to increase the ionization rate and so make up the deficit in thermionic emission with field emission. Similarly, if the mercury temperature is too low, the required ion generation can be obtained only by increasing the cathode drop and thereby increasing the ionization probability. Either of these conditions may result in a cathode drop which exceeds the disintegration voltage and injures the cathode. Sputtering — the name given to this harmful action — consists of gouging small particles of coating out of the surface by high-speed ion bombardment.

Let us summarize the general action in the arc discharge. Electrons are emitted from the cathode and are accelerated by a strong electric field to the edge of the cathode sheath. The energy so acquired causes the generation of positive ions throughout the main body of the arc or plasma. The plasma is occupied by normal and excited gas atoms and by ions and electrons in roughly equal numbers. It has only a small electric field which causes a drift current of electrons to the

anode. It is entirely surrounded by sheaths which contain nearly all the potential difference between the plasma and the physical boundaries. Electron space charge throughout most of the path is eliminated by the positive ions.

The total voltage or arc drop between cathode and anode is made up of the cathode drop, a small drop in the plasma, and an anode drop which may be positive, negative, or zero. The amount of the drop is dictated primarily by the nature of the gas and, for any one gas, decreases with an increase in gas density and to some extent with an increase in electrode area. The total arc drop is made up of the sum of all these drops and varies with arc current and gas density. The value of the arc drop is usually between 5 and 18 volts.

The total energy loss in the tube is equal to the arc drop multiplied by the arc current. In the high-vacuum tube, the energy loss is all dissipated by the anode; but in the gas-filled tube, this is not true. The total energy loss is distributed in many ways. Ion currents to the electrodes and to the walls account for some of the energy. Some of the energy is lost by radiation and some by electron impact at the anode. Not very much is known about the relative amounts of energy lost in various ways. There is some evidence which indicates that the energy loss at the anode is not more than half of the total.

These experimental and theoretical considerations may be an aid in understanding the performance of the many useful forms of gas-discharge tubes.

42. Two-electrode gas- or vapor-filled tubes. The two-electrode tube is made in a variety of forms to suit specific needs. All have a vacuum-tight chamber which in some tubes is made of glass and in others of steel. The cathode is one of two types. It may be a barium-coated filament or an indirectly heated surface, or it may consist of a mercury pool. We will consider the hot-cathode type first.

We have seen how the formation of thin sheaths over all the boundary surfaces and the high conductivity of the plasma remove many of the restrictions of electrode size and

shape. The electrodes may be designed to have other desirable features, such as rigidity, large heat-radiating surfaces, etc. In particular, we may use the heat-insulated cathode structures described in an earlier chapter. In the high-vacuum tube, heat shields cannot be used because they would act also as electrostatic shields. Such shielding would in turn require very much larger anode voltages and consequent anode losses. The following example is typical of the difference in the two cases.

	High-Vacuum Tube	Gas-Filled Tube
Cathode Power.....	6.8 kw	0.32 kw
Rated current.....	10 amp	70 amp

These tubes have many advantages over high-vacuum tubes for rectifier service. The low voltage loss and the resulting low power loss permits the construction of rectifiers which operate with very high efficiency. Furthermore, the removal of many restrictions on cathode design permits the construction of tubes for service in high current rectifiers.

During one-half of the voltage cycle, the tube must remain non-conducting, and it is during this inverse cycle that the greatest voltage strains are imposed on the tube. In general, gas- or vapor-filled tubes break down under reverse voltage stress more easily than high-vacuum tubes do. An arc discharge in the reverse direction, i.e., from anode to cathode, is called "arcbak." Many causes contribute to arcbak. Foreign gases adsorbed on the surface of the anode or buried in the anode material seem to cause arcbak trouble.

In general, the voltage at which arcbak occurs varies, in a given tube, inversely as the vapor pressure; that is, high vapor pressures lead to low arcbak voltages. The curve shown in Fig. 51 is typical of the variation of arcbak voltage with mercury-vapor pressure.

Paradoxically, operation with too low a value of mercury-vapor pressure may also cause arcbback. Arcbback in this case is usually due to voltage surges set up in multi-tube circuits when any tube fails to carry its share of load current at the proper time.

Arcbback may also occur through mistreatment, such as the passage of large peak currents which exceed the tube rating or by operating the cathode under temperature. In either case, small pieces of the cathode material may be sputtered off and deposited on the anode or other parts of the tube. This highly emissive material can cause reverse electron emission leading to arcbback.

The tube does not attain its maximum non-conducting ability at the instant that the forward current ceases. Immediately after the load current stops flowing, there is left in the tube a high density of positive ions which must be removed before the tube is capable of withstanding maximum inverse voltage. The process of sweeping out these residual ions is called deionization, and the time required is called the deionization time. In some multi-tube rectifier circuits, and where the load is highly inductive, the inverse voltage builds up very rapidly. These conditions are conducive to arcbback because very little time is permitted for deionization.

The contributory factors are largely eliminated by careful construction and inspection. Each tube type is given a peak inverse voltage rating which must not be exceeded.

Fig. 52 shows a group of mercury vapor-filled, two-electrode tubes covering a wide range of current and voltage ratings.

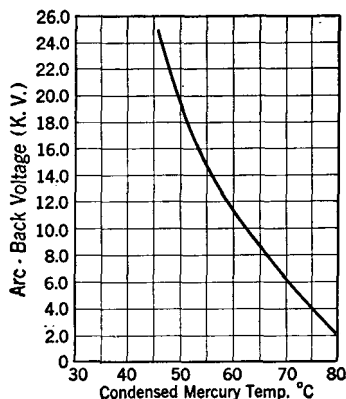

FIG. 51. Curve illustrating the effect of mercury-vapor pressure on arcbback voltage.

43. **Three-electrode, gas- or vapor-filled tubes.**^{1, 2, 10} A vast increase in the versatility of the gas-filled tube may be obtained by adding a control electrode to the two-electrode tube. The circuit action of the two-element high-vacuum tube and that of the two-element gas-filled tube are

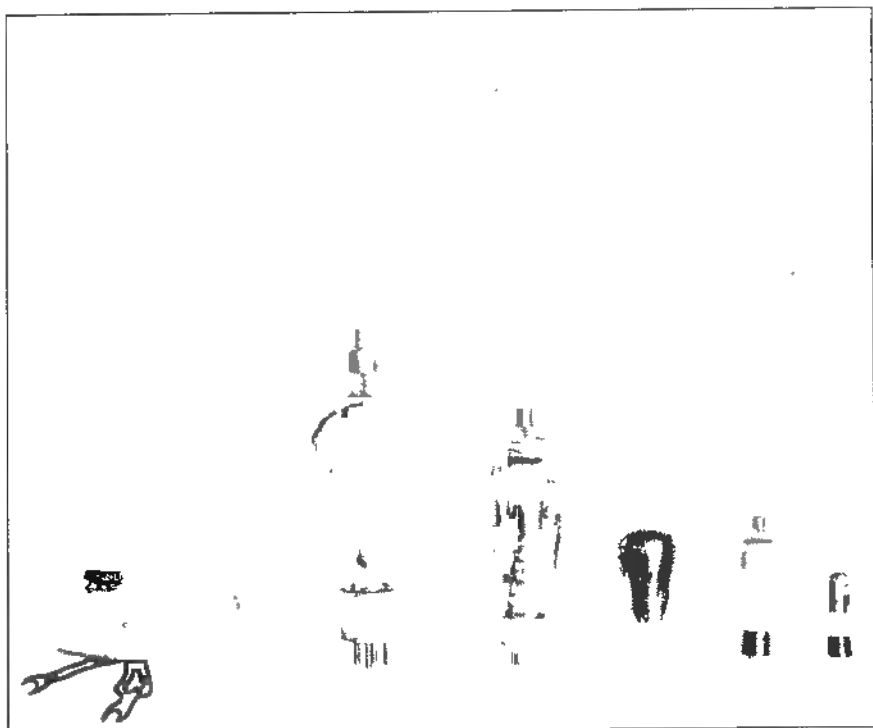

FIG. 52. A group of two-electrode, mercury-vapor-filled tubes. The average current rating, in amperes, of these tubes is: (from left to right) 100A., 12.5A., 6.4A., 2.5A., 0.5A., 0.125A.

very similar, but the corresponding three-electrode tubes have quite different electrical characteristics.

This type of tube is usually of the end-on construction: the cathode at one end of the tube and the anode at the other. The control element or grid is a metallic cylinder enclosing the whole arc stream and provided with one or more internal disc-like partitions or baffles placed between

the cathode and anode. The baffles are penetrated with one or more holes, depending on the characteristics which are required.¹⁶

It has been shown that the starting of an arc discharge between an emitting cathode and an anode immersed in a gas depends on the formation of positive ions in the inter-electrode space. We found also that, in any given tube, the arc would not start until the electron current had reached a certain minimum value which depended on the anode voltage. The versatility of the three-electrode tube lies in the control of the starting current afforded by the grid, no matter what the anode voltage may be. The ratio of anode voltage to grid voltage at which the plasma forms may be made so large that a grid potential of a few volts can prevent breakdown to an anode which has a positive potential of thousands of volts with respect to the cathode. Arc formation can be not only prevented but also forced, when the anode voltage is so low that it is unable to draw the necessary starting current.

However, as soon as a plasma is formed, a positive-ion sheath is built up around every part of the grid. Since the whole potential difference between the grid and the plasma is confined to this sheath, no applied grid potential changes can do more than change the sheath thickness. Consequently, once the plasma is established, the grid has no further effect on the amount of anode current.

It is possible to stop the discharge in certain cases by making the grid sheaths so thick that adjacent sheaths overlap. The plasma is then divided into two parts, and very few electrons will be able to pass from the cathode plasma through the grid sheaths to the anode plasma. If this condition can be maintained until the positive-ion generation falls below the amount required for plasma maintenance, the discharge will stop. This means of control is not ordinarily used except for small arc currents and low gas pressures because of the high grid voltage required and the destructive ion bombardment of the grid.

In practice, the grid is used to start or prevent the starting of the arc, but not to control the magnitude of the current after the discharge is established.

The arc can be stopped easily by lowering the anode voltage, and, consequently, the plasma potential, until the required rate of ion generation can no longer be maintained. If the anode voltage be made so low that the arc stops, the grid can regain control as soon as the positive ions have been removed from the space around the grid. The length of time required for these ions to be removed and for the grid

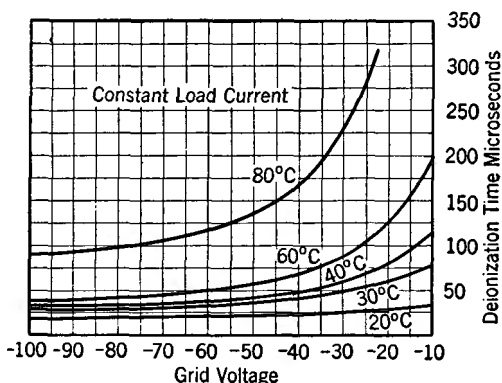

FIG. 53. Relation between grid voltage, mercury temperature, and deionization time for one type of three-electrode tube.

to regain control is called the “deionization” time. This time varies from about ten to several hundred microseconds. The deionization time varies directly with gas pressure and arc current and inversely with negative grid and anode voltage. Fig. 53 illustrates the variation of deionization time with grid voltage and temperature.

The formation of the arc discharge also requires a definite length of time, called the “ionization” time. This time is required for the ions to reach all parts of the discharge path. The ionization time is usually very much smaller than the deionization time, and increases with an increase in length of the discharge path but decreases with an increase in gas pressure. Fig. 54 shows this relation in a typical tube.

In the three-electrode tube, the term "plate resistance" has no meaning because the anode voltage does not completely determine the arc current. In practice, the arc voltage is considered a dependent variable. Similarly, the term "transconductance" has no meaning because the grid has no effect on the magnitude of the current flow. The amplification factor at cut-off of a high-vacuum tube is somewhat analogous to the "control ratio" in a gas-filled tube because both terms are a measure of the grid voltage required to prevent the flow of anode current. Furthermore,

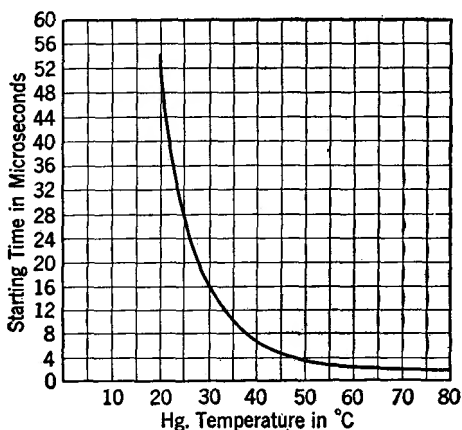

FIG. 54. The time required to establish full conductivity, that is, the "ionization time," and the effect of the mercury-vapor pressure.

both terms refer primarily to the shielding effect of the grid on the cathode.

Gas-filled tubes may be divided roughly into two classes according to their characteristics. One class includes the so-called "positive tubes." In these, the discharge will not start until the grid has been made 6 to 12 volts positive with respect to the cathode. The other class contains the "negative tubes" which are designed so that the discharge will start unless the grid is maintained a definite amount negative with respect to the cathode.

Fig. 55 shows a typical breakdown characteristic for a

positive mercury-vapor-filled tube, and Fig. 56 shows the relation between grid voltage and anode voltage for a nega-

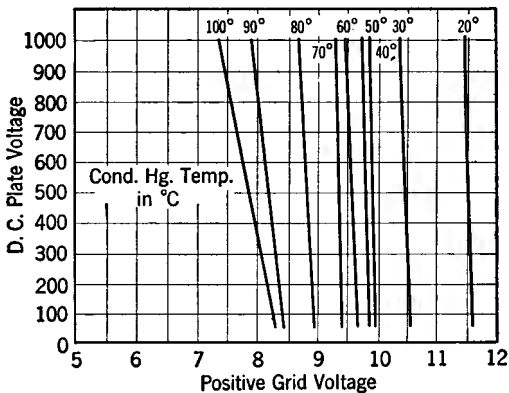

FIG. 55. Breakdown characteristic of a positive-grid, three-electrode tube. Note the variation due to changed mercury-vapor pressure and the relative unimportance of plate voltage.

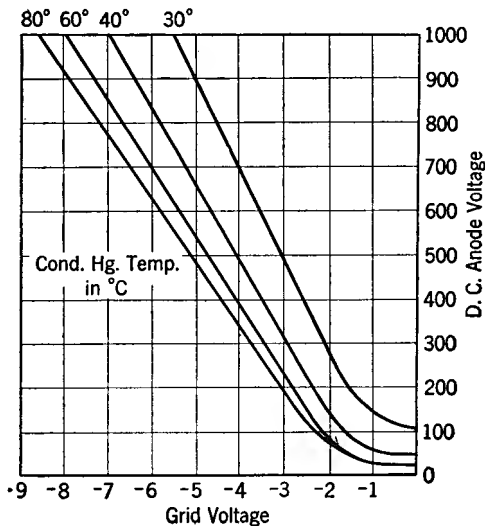

FIG. 56. The critical grid voltage or break-down characteristic of a typical negative-grid, mercury-vapor filled tube. Grid voltages to the left of each curve prevent arc formation whereas those to the right permit full conduction.

tive tube. We see from these curves that the control ratio of the gas-filled tube is not a constant. It varies throughout

the whole range of anode voltage and may be positive or negative, depending on the tube design. The control ratio varies also with molecular density and in general decreases as the density increases. The reason is found in the dependence of ion generation on voltage and gas density.

The characteristics displayed by the positive tube are obtained by making the grid shielding so effective that the anode voltage has practically no effect on the potential in the neighborhood of the cathode. The electron current leaving the cathode is, therefore, independent of anode voltage. In the negative-grid tubes, the shielding is not as effective and the electron current leaving the cathode is not independent of anode voltage.

The distinction between the two kinds of control characteristics may be made clearer by Figs. 57 and 58. Fig. 57 shows the electric field distribution in a positive tube due to a grid and anode voltage combination which will cause breakdown.

Fig. 58 gives the same information for a negative tube. Neither of these charts is strictly true because they do not include space-charge effects. However, they do serve to illustrate several points. The charts are really contour maps, and the curves are equipotential lines which connect all the points in space which have the same potential.

Fig. 57 shows that the grid shields the cathode so well that the anode potential has practically no effect in the grid-cathode region. The potential here is determined entirely by the grid. In this type of tube, electrons cannot leave the cathode, and the arc cannot start until it is forced to do so by making the grid positive. Therefore, we expect the breakdown characteristic to be nearly independent of the anode voltage. Fig. 58, however, shows that the potential in all parts of the negative tube depends to a great extent on the anode voltage. For all voltages except the lowest, enough electron current will flow to the anode to start the discharge unless the current is reduced by making the grid negative with respect to the cathode. Since the grid does not en-

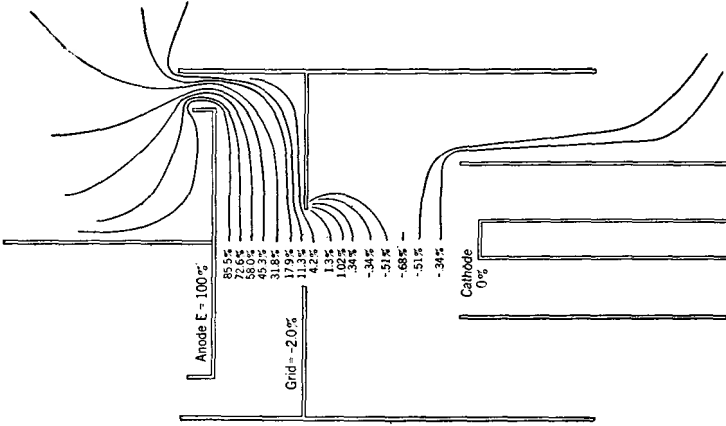

By permission of the publishers of *Electronica*.
 Fig. 58. Potential distribution in a "negative-grid" tube at breakdown.

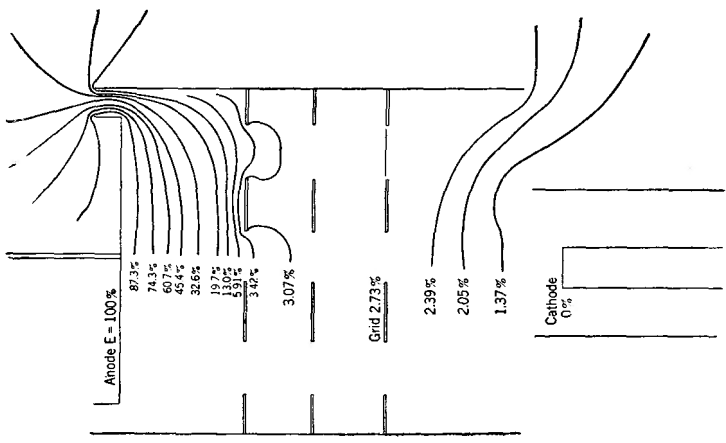

Fig. 57. The potential distribution in a "positive-grid" tube for a combination of electrode voltages which would just cause breakdown.

tirely shield the cathode from the anode, higher anode voltages require higher negative grid potentials to prevent breakdown.

The low anode voltages cannot draw the required starting current, and the grid must be made positive to increase the pre-arc current.

Fig. 58 shows that, at the point of breakdown, the potential in space near the cathode is negative. This means that electrons which leave the cathode do so only by virtue of their initial velocities. The initial velocity is, of course, determined by cathode temperature, and, therefore, we expect that the starting characteristic of the negative tube will be influenced slightly by cathode temperature.

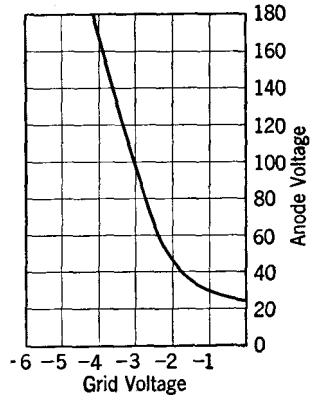

FIG. 59. The breakdown characteristic of an argon-filled tube.

Figs. 57 and 58 represent the potential distribution in the tube only when the space charge is very small. Breakdown is much the same sort of process as it is in the two-electrode tube. The formation of a few ions raises the potential of

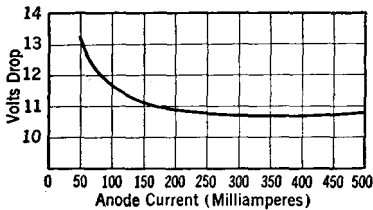

FIG. 60. Arc drop curve for a tube filled with argon.

those regions in space which originally had the potential distribution shown, for example, by Fig. 58. The increased current flow creates more ions and rapidly establishes a plasma throughout the tube and sheaths over the electrodes.

Fig. 59 shows the control characteristic of an argon-filled tube. Notice that the curve is of the same general nature as for a mercury-filled tube, but, for reasons discussed earlier, there is no temperature effect, and, therefore, there is only a single curve. Fig. 60 shows the arc-drop curve for the argon-filled tube.

44. Magnetic control of gas- or vapor-filled tubes.

Another useful way of controlling gas-discharge tubes is afforded by an external magnetic field.¹⁷ Fig. 58 shows that, prior to the start of an arc, the electric field in the tube is such that an electron cannot be given enough energy to cause ionization until it has reached the vicinity of the opening in the grid baffle. If, by some means, we can prevent the electrons from reaching these higher field strength regions, we can prevent breakdown. A magnetic field applied perpendicular to the tube axis will accomplish this result. Electrons leaving the cathode are accelerated toward the grid opening but are deflected from their normal paths by the transverse magnetic field. The moving electrons act just like a wire carrying current and are subjected to the same forces by the magnetic field. Many electrons are forced to return to the cathode, and some are collected by the grid if it is near cathode potential. The result is that the electron current available for ion production in the grid-anode region is reduced, and breakdown does not occur.

The magnetic field required is relatively small because the electric field between grid and cathode is so weak that the electrons never acquire very high velocities. Practically any three-electrode tube may be controlled in this way.

The grid may be used in conjunction with the magnetic field, and then breakdown is determined by the simultaneous action of the two controlling forces. If the grid bias is large, the magnetic field may be small or, conversely, control may be obtained by a relatively strong magnetic field and a smaller grid-bias voltage.

The electrostatic and magnetic methods of control each have certain characteristic advantages and disadvantages which will be discussed when we consider the applications of these tubes.

Fig. 61 shows a typical magnetic control characteristic taken on the same tube which gave the electrostatic control characteristic in Fig. 56.

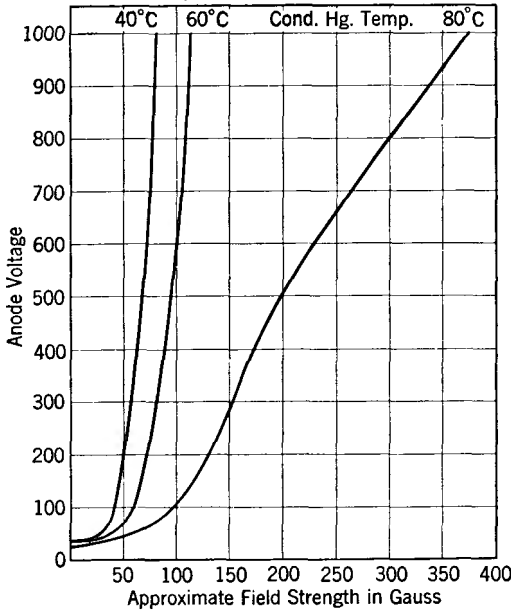

FIG. 61. A typical set of magnetic-control curves for a three-electrode, mercury-vapor tube. These curves show the relation between the transverse magnetic field intensity and the anode voltage required for breakdown. The data for these curves were taken with the control-grid voltage held at zero.

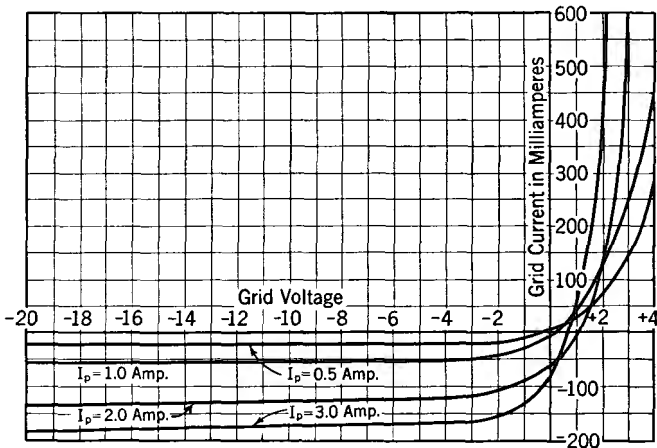

FIG. 62. The grid current after breakdown in a negative-grid, mercury-vapor-filled tube.

45. Grid current. One very important characteristic of the grid-controlled tube is the grid current which flows both before and after the arc starts. The pre-arc grid current is much smaller than the current which flows after breakdown. The transition from one value to the other occurs at the instant of breakdown and in a very short time.

There are really two grid-current characteristics: one which obtains up to the point of breakdown and one which holds after the arc starts.

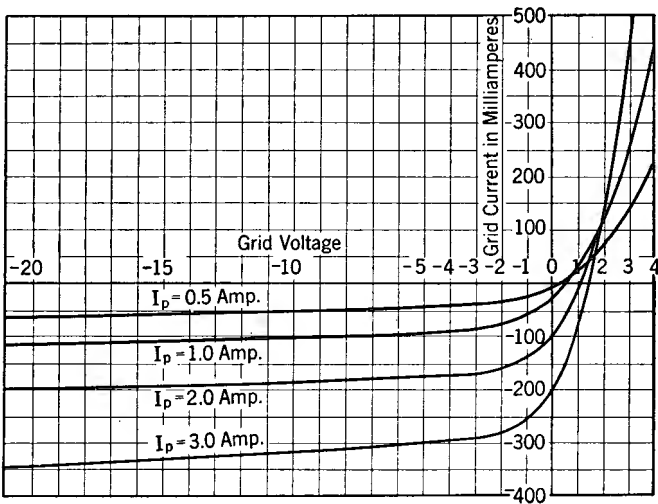

FIG. 63. The grid current after breakdown in a positive-grid, mercury-vapor-filled tube.

The current flow after breakdown, or firing as the arc formation is often called, consists of positive-ion current flow through the grid sheath, if the grid is negative, or electron current if the grid is driven slightly positive. Fig. 62 shows the grid-current characteristic for a typical negative-grid, mercury-vapor-filled tube, and Fig. 63 shows the same characteristic for a positive-grid tube. These curves were obtained with the same tubes which have the control characteristics shown in Figs. 55 and 56. Fig. 64 shows the grid current which flows after breakdown in a typical argon-filled tube.

The grid current before breakdown may be a composite current from a number of sources. It normally consists of a small current of electrons or positive-ions depending on the grid polarity. In addition, there may be some leakage current, and there may be some thermionic emission current from particles of cathode coating material which have been evaporated or sputtered from the cathode and condensed on the grid. Another source of grid current is the electrostatic capacity between the grid and anode. This capacity couples

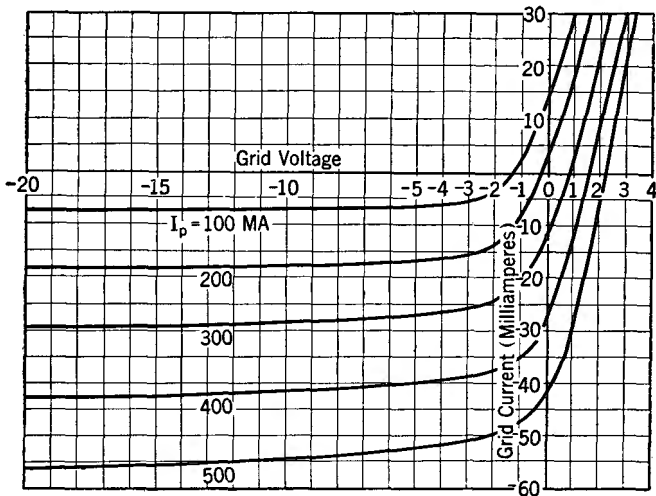

FIG. 64. The grid current after breakdown in a typical argon-filled tube.

the grid circuit to the load circuit and may introduce unwanted voltages in the grid circuit from disturbances arising in the line or load circuit.

All these factors introduce difficulties when the tube is used with the high-resistance grid circuits which are desirable if the tube is to be controlled by a phototube or other low-power source.

Thermionic grid emission is probably the most troublesome of all the factors contributing to grid current. It causes large and unpredictable voltage losses in the grid circuit, and, in addition, there may be enough emission from the grid

to the anode to start an arc. In the latter event, the grid may lose all control. Voltage losses in the grid circuit sometimes force a readjustment of the circuit when tubes are replaced.

The grid receives heat from the cathode and anode by radiation and from the ion or electron currents in the arc stream. The grid temperature and, hence, grid emission, are dependent to some extent on the load conditions.

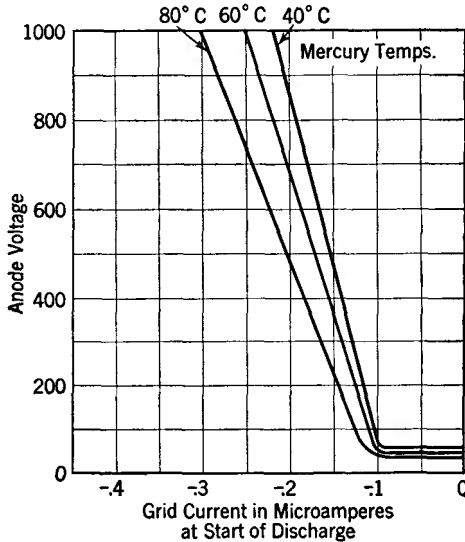

FIG. 65. The grid current just before breakdown in a typical three-electrode tube filled with mercury vapor.

Grid emission is minimized by using grid structures which operate as cool as possible and by sintering the cathode at the lowest possible temperature consistent with proper activation. The possibility of activating the grid supplies another reason why conditions leading to cathode sputtering should be avoided. The grid current before breakdown in the negative-grid tube we have been discussing is shown in Fig. 65.

46. Shield-grid gas- or vapor-filled tubes.¹⁸ Many of the circuit difficulties which arise from the flow of grid current

prior to firing may be eliminated or minimized by the addition of a second grid.

The general construction of this type of tube is similar to the single-grid type. The electrode which serves for a control grid in the three-electrode tube is used for a shield grid in the double-grid tube. It consists of a metal cylinder provided with internal baffles pierced with holes. There are usually two baffles, each having an axial hole to permit the arc to pass through. The control grid may be a series of small wire rings or a small graphite cylinder mounted axially between the two baffles. The control-grid lead is brought through the tube wall at some point remote from the other leads and is well insulated to reduce leakage currents. The control grid has a total area very much smaller than the usual grid structure, and the electron or ion current collected is reduced a corresponding amount. The electrostatic capacity between anode or cathode and control grid is reduced, by the shield grid, to such a low value that coupling between the control and load circuits has little effect.

Fig. 66 shows the pre-arc current to the control grid of a mercury-vapor-filled shield-grid tube. These curves show that the voltage loss due to grid current is small even though several million ohms may be used in series with the grid. Another advantage is the decreased thermionic emission from the control grid. The shield grid aids in two ways: it reduces the chance of activation by evaporated material from the cathode, and blocks part of the radiant heat from the cathode and anode. This makes the control characteristics more nearly independent of load conditions and improves the operating stability.

The potential of both grids is effective in controlling

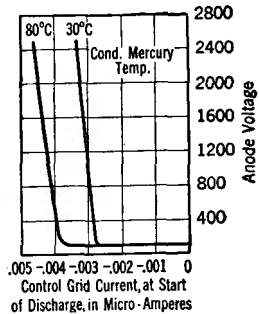

FIG. 66. The control-grid current at breakdown in a typical shield-grid, mercury-vapor tube.

breakdown, and, although the controlling voltage is not usually applied to the shield grid, it may be used to produce useful changes in the operating characteristic.

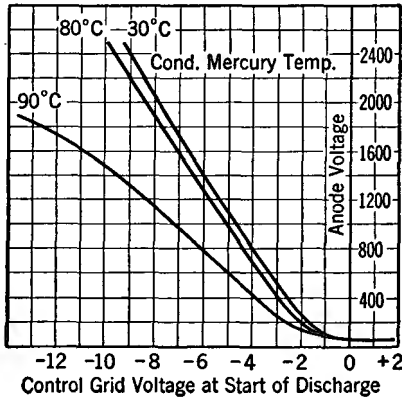

FIG. 67. The breakdown characteristic of one form of shield-grid, mercury-vapor-filled tube.

The family of curves in Fig. 67 shows the breakdown characteristic of one type of shield-grid tube, and Fig. 68

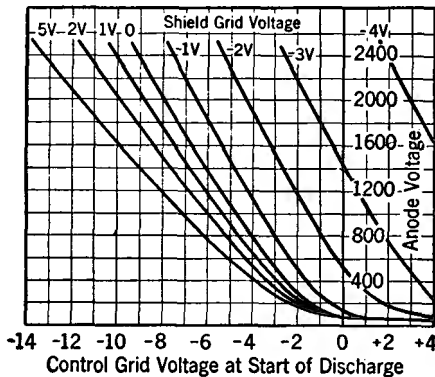

FIG. 68. The effect of shield-grid voltage on the breakdown characteristic of a shield-grid tube.

illustrates how the characteristics are influenced by changes in shield-grid potential. Fig. 69 shows the characteristics of a similar tube which uses argon instead of mercury vapor.

47. Pool tubes. There is one type of mercury-vapor-filled tube which we have not discussed yet. This type of tube has a pool of liquid mercury for a cathode.¹⁹ This principle is used for small tubes and also the huge, poly-phase, metal-tank rectifiers capable of supplying power for electric railroad systems.

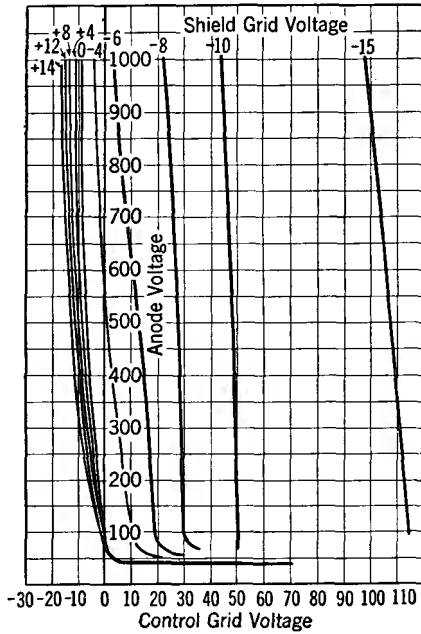

FIG. 69. The control characteristics of an argon-filled, shield-grid tube.

In its simplest form, the pool tube consists of an anode and a mercury pool enclosed in a vacuum-tight chamber of metal or glass. Connection is made to the pool by a metal lead extending through the envelope and immersed in the mercury. Fig. 70 shows a group of such tubes. In this picture, tube (a) is a small tube which has an average current rating varying from 1.0 to 2.5 amperes and a peak current rating from 100 to 800 amperes depending on the type of service. Tube (b) has somewhat higher ratings, and tube (c) is capable of handling an average current of 25

to 75 amperes, again depending on operating conditions, and a peak current of 5000 amperes.

Some method other than the application of rated anode voltage must be supplied to start the arc discharge because the cathode is cold and no emission is available.

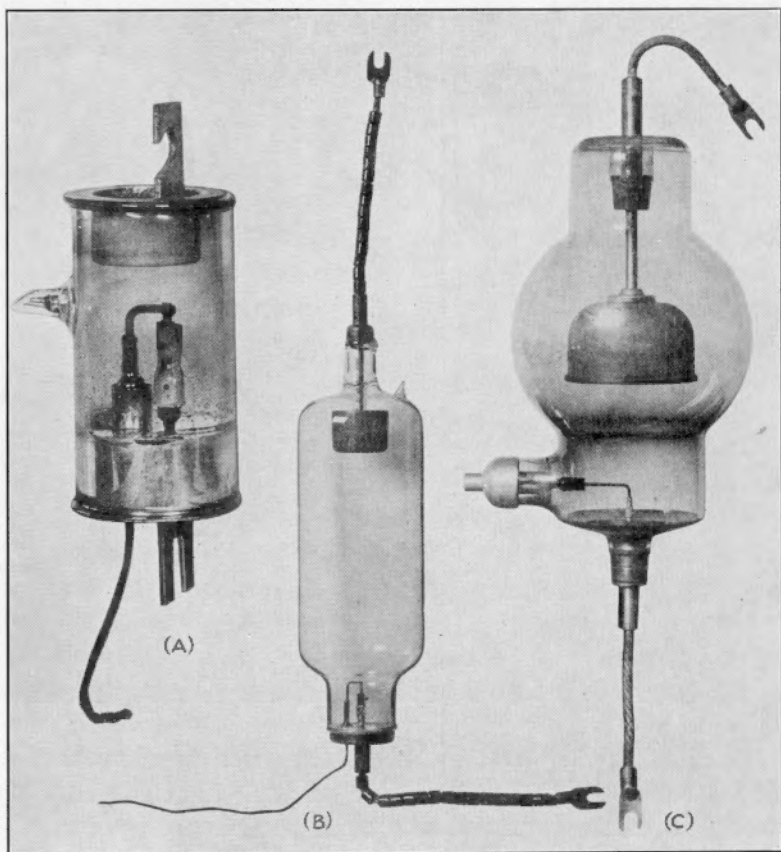

FIG. 70. A group of mercury-pool tubes equipped with immersed ignitors.

Let us assume, for the moment, that an arc has been started in such a tube and observe its operation. The most noticeable feature is an intensely bright spot traveling over the surface of the mercury pool at high speed and in random directions.

So long as the anode current is not allowed to fall below two or three amperes, the arc will continue. It becomes unsteady below this value and may go out.

The surface of the mercury pool is agitated by the forces acting at the cathode spot. Mercury vapor and metallic mercury ejected from the cathode spot create a high-pressure region immediately over the spot. Collisions between electrons and atoms in this region are frequent.

The only essential difference between the arc discharge in a pool tube and in a hot-cathode tube is in the cathode phenomenon. Various workers are not yet in complete agreement on the details of the cathode phenomenon, but the main facts have been determined.

The current density at the arc spot is about 4000 amperes per square centimeter. The current may be delivered by one spot or from several spots each delivering between 30 and 40 amperes. The temperature of the spot is about 200° C — a value much too low to permit the thermionic emission of electrons.

Many theories have been advanced to account for the electron emission at the cathode spot. Most of them have met serious difficulties and have been discarded. The general consensus of opinion is that the arc current is supplied by field emission from the cathode spot. Meager experimental data and theory show that, within the positive-ion sheath which covers the cathode spot, the electric field is high enough to account for the observed emission.

Lamar and Compton have found that the cathode drop is about 10.0 volts over a wide range of current and pressure values. Assuming the field theory of electron emission to be true, the ions must be formed by a two-stage process because about 4.5 volts of the 10.0-volt cathode drop are required to overcome the work function of the mercury surface. The remaining 5.5 volts are, of course, insufficient for ionization by single impact.²⁰

This cathode mechanism is the tube's chief virtue inasmuch as the arc can adjust itself to carry almost any amount

of current. Increased current demands are met by increased ionization. This raises the electric field at the cathode spot — or generates new spots — and supplies added emission to meet the demand. So far as the mercury pool is concerned, there is no emission limit, and the maximum allowable peak currents are dictated by other factors such as heating and arcbreak. This is illustrated by the set of typical ratings given in Table VII.

TABLE VII

Anode voltage	
Inverse (maximum)	800
Forward (maximum)	800
Anode current (amperes)	
Instantaneous (maximum)	
Multi-cycle operation	100
Half-cycle operation	
At 800 volts (peak)	200
At 650 volts (peak)	250
At 350 volts (peak)	800
Instantaneous (minimum)	2.5
Average (maximum)	
Multi-cycle operation	2.5
Half-cycle operation	
At 800 volts (peak)	1.0
At 650 volts (peak)	1.4
At 350 volts (peak)	2.0
Maximum time of averging anode current (seconds)	10
Starter	
Starting current (amperes)	
Instantaneous	
Maximum required	10
Typical required	3
Average (maximum)	0.3
Starting potential (instantaneous volts)	
Maximum required	150
Typical required	75
Inverse voltage (maximum)	0

Many methods of starting the arc have been used. Most of them involve some mechanical means of striking an arc between the pool and an auxiliary electrode. In these cases,

the arc is kept alive by passing a small current from the pool to a holding anode supplied with power from a separate source.

Slepian and Ludwig²¹ have discovered an electrical arc-ignition system which removes many of the objections to the older types. They found that an arc could be started between a mercury pool and an anode by the application of a low positive voltage to a rod of high-resistance material partially immersed in the mercury. Several materials such as clay-carbon mixtures, boron or silicon carbide, and carborundum crystals exhibit this property. They have proposed a theory of this method of arc ignition which states that the arc originates as a minute spark at the pool surface between the mercury and the immersed rod. This small arc flows to points of higher and higher potentials along the surface of the ignitor — owing to the potential gradient along the rod — and finally transfers to the main anode. The whole process consumes only a few microseconds and requires a rather high instantaneous starter current but relatively little power. Table VII gives the starter ratings for a typical tube.

BIBLIOGRAPHY

1. Some Characteristics of Thyratrons, J. C. WARNER, Proceedings Institute Radio Engineers, September, 1931.
2. Hot Cathode Thyratrons, A. W. HULL, General Electric Review, April and July, 1929.
3. Production of Light from Discharges in Gases, SAUL DUSHMAN, General Electric Review, June, 1934.
4. The Interaction of Electron and Positive Ion Space Charges in Cathode Sheaths, IRVING LANGMUIR, Physical Review, June, 1929.
5. Electric Discharges in Gases at Low Pressures, IRVING LANGMUIR, Journal of Franklin Institute, September, 1932.
6. Electrical Discharges in Gases, Part I, K. T. COMPTON and IRVING LANGMUIR, Reviews of Modern Physics, April, 1930.
7. Electric Discharges in Gases, LEWI TONKS, Electrical Engineering, February, 1934.
8. Fundamental Electrical Properties of Mercury Vapor and Monatomic Gases, A. W. HULL, Electrical Engineering, November, 1934.

9. General Theory of the Plasma of an Arc, LEWI TONKS and IRVING LANGMUIR, *Physical Review*, September, 1929.
10. Characteristics and Functions of Thyratrons, A. W. HULL, *Physics*, February, 1933.
11. Electric Discharges in Gases, Part II, K. K. DARROW, *Electrical Engineering*, March, 1934.
12. Electric Discharges in Gases, Part III, J. SLEPIAN and R. C. MASON, *Electrical Engineering*, April, 1934.
13. The Theory of Collectors in Gaseous Discharges, H. M. MOTT-SMITH and IRVING LANGMUIR, *Physical Review*, October, 1926.
14. A New Method of Investigating Thermionic Cathodes, C. G. FOUND, *Physical Review*, April, 1934.
15. Gas-Filled Thermionic Tubes, A. W. HULL, *Transactions American Institute Electrical Engineers*, July, 1928.
16. Engineering Features of Gas-Filled Tubes, H. C. STEINER, A. C. GABLE and H. T. MASER, *Electrical Engineering*, May, 1932.
17. Magnetic Control of Thyratrons, E. D. McARTHUR, *Electronics*, January, 1935.
18. Shield Grid Thyratrons, O. W. LIVINGSTON and H. T. MASER, *Electronics*, April, 1934.
19. Mercury Arc Rectifier Phenomena, D. C. PRINCE, *Journal American Institute Electrical Engineers*, August, 1927.
20. Potential Drop and Ionization at Mercury Arc Cathode, E. S. LAMAR and K. T. COMPTON, *Physical Review*, May, 1931.
21. A New Method of Starting an Arc, J. SLEPIAN and L. R. LUDWIG, *Electrical Engineering*, September, 1933.

CHAPTER VIII

APPLICATION OF GAS- OR VAPOR-FILLED TUBES

48. Principles of control. The applications of these tubes fall roughly into two classes. One of these classes comprises all the applications in which the current utilized by the load is controlled directly by the tube. The other class includes all applications in which the tube indirectly controls the desired power flow. Both classes utilize the tube's ability to control the flow of a large amount of power in the plate circuit in a predetermined manner with the expenditure of a small amount of power in the grid circuit.

In a direct-current circuit, some means other than the grid circuit is ordinarily provided to stop the current flow. In an alternating-current circuit, the discharge is automatically stopped when the anode becomes negative in every alternate half cycle. During the half cycle when the anode is negative — that is, the inverse half cycle — the discharge stops and the grid sheath disappears. Consequently, if the period of the inverse half cycle is greater than the deionization time of the tube, the grid will have regained control at the beginning of each positive or forward half cycle. The average value of the load current can be regulated independently of anode voltage or resistance by arranging the grid voltage to permit the discharge to start at any predetermined time interval after the beginning of the forward half cycle. Consequently, although the grid has no effect on the instantaneous value of load current, the average can be changed at will. For this reason, the tube is ideally suited for many applications in alternating-current circuits. The average current through the load resistor R of Fig. 71 may be controlled in this way. No current will flow during

the inverse cycle, and the fraction of the forward cycle during which the tube is conductive is controlled by the grid circuit.

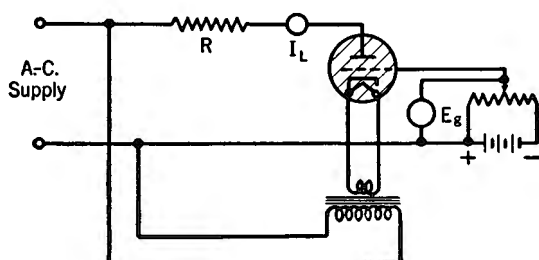

FIG. 71. Circuit for measuring the control characteristic of a three-electrode gas-filled tube.

The instantaneous value of load current is determined by the applied voltage and the load resistance. Fig. 72 shows the

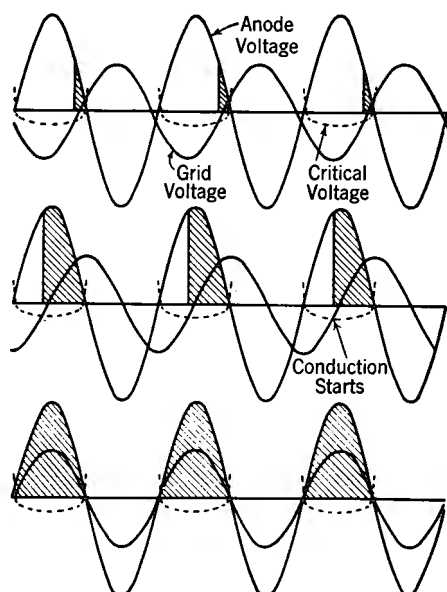

FIG. 72. The variable conduction period obtained by shifting the phase relation of the grid and anode voltages. The phase-shift method permits complete control of the average current flow in a gas-filled tube.

effect of changing the conducting period. The two most important ways of controlling the conducting period are

known as amplitude control and phase-shift control. In Fig. 71, the grid circuit is arranged to give one form of amplitude control.

The voltages imposed on the tube are best shown by the voltage diagram, Fig. 73. The curve e_s represents the supply voltage impressed through R on the plate of the tube. The control characteristic of the tube gives the value of grid voltage which will permit breakdown for each instantaneous value of plate voltage. These values of grid voltage plotted in the same diagram give the critical-grid-voltage curve e_c .

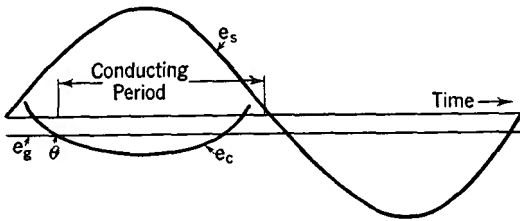

FIG. 73. The relation between supply voltage, critical voltage, and grid voltage. Conduction begins at the point θ and continues almost to the end of the positive half cycle.

Any value of grid voltage equal to, or more positive than, e_c will render the tube conducting, and, conversely, grid voltages more negative than e_c will prevent conduction. Therefore, if at any time during the cycle, the grid becomes more positive than e_c , a discharge will start. The grid will then lose control and the tube will remain conducting until the discharge is stopped by the lowered anode voltage at the end of the cycle. For example, if a constant voltage, represented by e_g on the diagram, be supplied to the grid, the tube will become conducting at the point θ in every forward cycle and remain conducting until the end of the forward half cycle. The fraction of a cycle between the point θ and the end of the forward half cycle, that is, the conduction period, can be controlled by arranging the grid circuit so that the grid-voltage curve intersects the critical curve at any desired point between zero and 90° . In this way the average current flowing in the load circuit may be controlled.

This circuit has the disadvantage that the control is exercised only for the first 90° because a constant grid voltage cannot be made to intersect the critical curve after the 90° point.

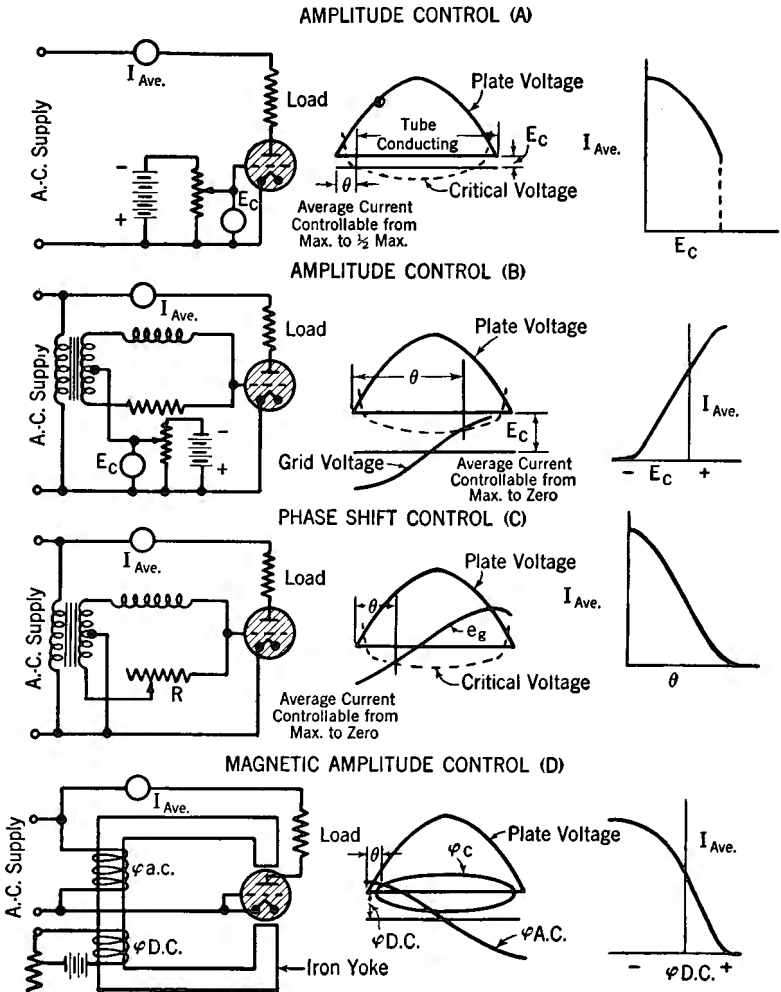

Fig. 74. Chart to show the basic features of the various methods of controlling gas-filled tubes.

Fig. 74 shows the essential features of various control systems.¹ Amplitude control is shown in section A.

No matter what kind of grid circuit is used, the average current through a resistance load will be related to the firing angle θ by the relation:

$$I_{\text{ave}} = \frac{I_m}{2\pi} (1 + \cos \theta).$$

The peak current I_m can be found from the value of load resistance and supply voltage. For reactive loads, similar computations are more involved.

Section *B* of Fig. 74 shows another form of amplitude control. Here, an alternating voltage is superimposed on the grid-bias voltage. The reason for the alternating component is twofold. Inspection of section *A*, Fig. 74, shows that, near the 90-degree point, the grid voltage and critical voltage are nearly parallel for several degrees. The firing point becomes erratic under these conditions because slight variations in load voltage or temperature will cause a wide variation in the firing angle. This effect is largely eliminated by using a relatively high bias and a correspondingly large alternating grid voltage. Then, the angle of intersection between the critical voltage and the grid voltage is large and errors in timing are minimized. The deviation in characteristics from one tube to another becomes less important and, usually, tubes can be replaced at the end of their life without further circuit adjustment.

By the use of a compound grid voltage, we can also gain control of the firing angle throughout the whole forward cycle.

In *C* of Fig. 74 is shown a still different method of control called phase-shift control. The grid voltage is a simple, alternating voltage, either sinusoidal or peaked, supplied from a source which can change the phase relation between the grid voltage and plate voltage. Phase shift may be accomplished by resistance variation in a network such as the one shown or from certain types of wound-rotor induction motors. The variation in firing angle can be visualized if, in Fig. 74, we imagine that we can slide the grid-voltage

wave to the left or right along its axis and stop at any desired point.

All these methods of control apply to magnetic control as well. Amplitude control may be accomplished up to the center of the forward cycle by simply varying the intensity of a unidirectional field — or throughout the whole cycle by supplying an alternating field from a phase-shifting source.

There is shown at *D*, Fig. 74, an amplitude method of control which is capable of changing the average current smoothly from maximum to zero. Since the polarity of the magnetic field makes no difference, the critical value of flux ϕ_c is shown plotted above as well as below the axis. The first intersection of either curve after the beginning of the cycle determines the firing point.

There are many variations of these control schemes, but they are mainly in the way the control voltage is applied to the grid. For example, many devices use the tube like a

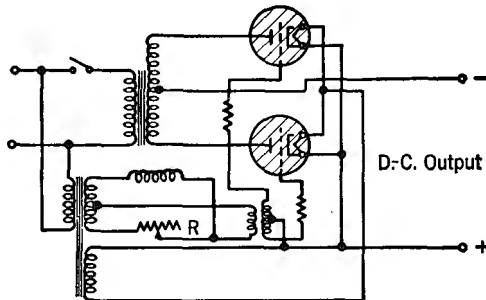

FIG. 75. A circuit for a controlled rectifier using gas-filled tubes.

relay^{2,3} in that it is either completely non-conducting or passing full current. These devices use a large bias applied to the tube to prevent firing until the application of the control voltage. When the control voltage is applied, the tube conducts current for the full forward cycle, whereas, in the absence of control voltage, the load current is zero.

These control methods are incorporated into many useful devices. Fig. 75 shows how the phase-shift control can be adapted to give voltage control in a rectifier. The amount

of load current is controlled by changing R in the phase-shift network. Of course, any other source of variable phase voltage may be used. The same principle may be extended to polyphase circuits.

The phase-shift method of control is utilized in rectification^{4, 5} from alternating current to direct current where control is desired for such applications as motor-speed control, battery charging, generator excitation, laboratory power supply, and illumination control.

An arrangement whereby a shield-grid tube can be controlled by a phototube is shown in Fig. 76. In this case, the tube will become conducting and deliver rectified current to the load when light of any desired intensity falls on the phototube.

This result is attained by applying to the control grid (connection on the side of the bulb) an alternating voltage in phase with the plate voltage. This potential is applied in series with the phototube. The tube is biased varying amounts by an additional voltage applied to the shield grid. Adjustment of the two potentiometers furnishes control of the sensitivity and operating light level.

The circuit can be arranged so that the tube is either on or off when the phototube is illuminated, by changing the phase of the grid voltages.

Operation from a vacuum-tube amplifier is desirable when greater sensitivity is needed. Many other circuits can be readily devised for continuous light-level indication or for light-intensity comparison using two phototubes.

The load circuit may include an indicating device or a relay, and it can be applied to the control of automatic

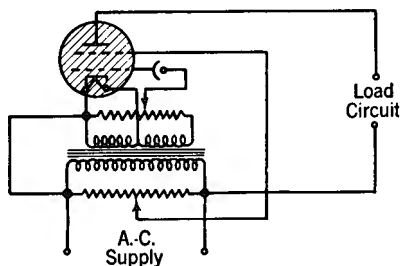
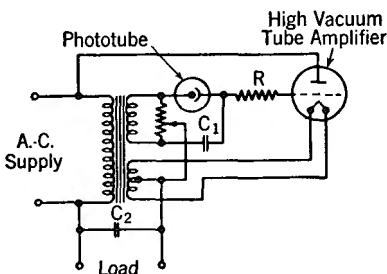

FIG. 76. A shield-grid, mercury-vapor-filled tube and a phototube are combined in this circuit. This is one of many circuits for a light-sensitive relay.

scales, color selectors, automatic counters, safety-gate operators, position indicators, door openers, street-lighting control, smoke detectors, etc.

Another form of phototube relay using a high-vacuum amplifier tube is shown in Fig. 77. The grid winding is connected in opposite phase to the plate voltage so that during the inverse cycle, when the amplifier tube anode is negative, the grid is positive and the condenser C_1 charges up through the resistor R . On the forward half cycle, the condenser retains its charge so long as no light falls on the phototube. The amplifier tube is biased beyond cut-off, and no plate current flows in the load. If, however, the



. . . D. E. Chambers, *Electrical Engineering*,
Jan., 1935.

FIG. 77. A phototube relay or control circuit using a high-vacuum tube and a phototube.

phototube is illuminated, it will discharge the condenser early in the forward cycle and reverse the charge. The grid becomes positive and allows plate current to flow. This process is repeated every cycle, and current flows in the load as long as the phototube is illuminated. This circuit is often used to control the grid voltage of a mercury-

vapor-filled tube which, in turn, supplies current to a relay, contactor, or indicator.

Alternating current can be controlled by the use of a saturable reactor and two gaseous-discharge tubes. The fundamental circuit is shown in Fig. 78. The saturable reactor has d-c windings which saturate the magnetic circuit and reduce the impedance of the a-c winding. With no direct current flowing, the impedance of the a-c winding is very high. If the direct current be supplied from a controlled rectifier, the current through the a-c winding can be varied smoothly from nearly zero to maximum by the grid control in the rectifier.

This form of control has been applied to theater lights, heating units, spot welders, etc.

Gas- or vapor-filled tubes may be used to convert direct current into alternating current. A circuit arranged to do

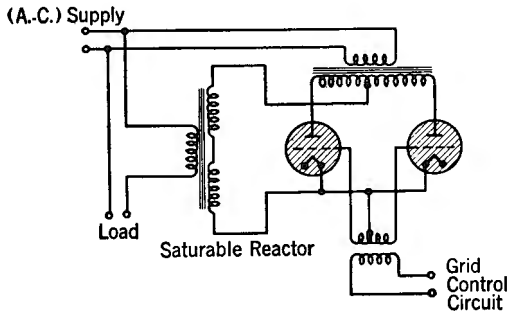

FIG. 78. The fundamental circuit elements for controlling alternating current with a saturable reactor and grid-controlled, gas-filled tubes.

this is called an inverter.⁶ Of the many types of inverter circuits, two are shown here.

When a d-c supply voltage is applied to the inverter circuit shown in Fig. 79, the anode potential of both tubes is

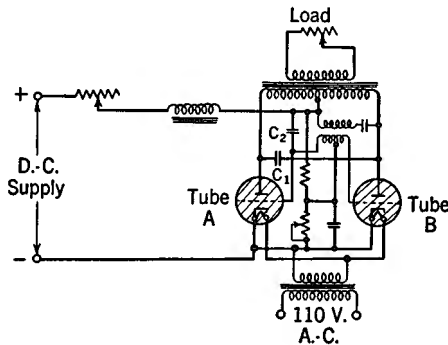

FIG. 79. The circuit for one form of inverter using two grid-controlled, gas-filled tubes.

raised and both tubes will break down if there is no discrimination between the two. The starting condenser C_2 serves to raise the grid potential of tube A momentarily so that it becomes conducting in preference to tube B. The

rise of current through this tube is limited by the reactor and half of the transformer winding.

The flux due to this rising current induces a voltage in the reactor and transformer windings which tends to restrict the current flow and at the same time induces voltages in the grid transformer and the other half of the power transformer. The grid voltages must be applied in such phase that tube *A* continues to conduct and tube *B* is held "open." The condenser C_1 then becomes charged to the potential difference developed by the transformer winding. During this charging period, the voltage across tube *A* is equal to the normal arc drop of about 10 to 15 volts, but the anode voltage of tube *B* is increasing. At some point in the cycle, determined by the grid-circuit constants, tube *B* will become conducting and its anode voltage will immediately fall to the arc-drop value. The condenser C_1 cannot immediately discharge

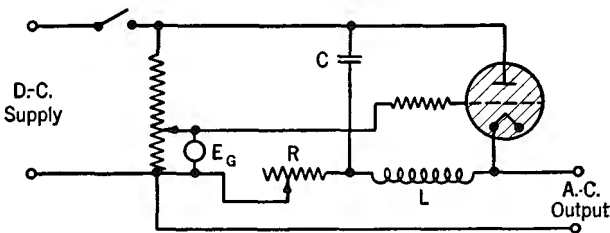

FIG. 80. A circuit for using a gas or vapor-filled tube as a single-tube inverter.

through the transformer because of the high transient impedance of the windings, and, therefore, the high voltage across the condenser can be accounted for only by driving the anode of tube *A* negative by nearly the amount of the condenser voltage. Conduction in tube *A* then ceases, and the potential of the anode begins to rise as the condenser discharges. If the anode of tube *A* remains negative long enough, the grid sheath will disappear and the grid will regain control. The sequence of events already described for the various circuit elements will repeat with tube *B*, which is conducting, now playing the part previously played by tube *A*.

The connection diagram in Fig. 80 applies to a single-tube inverter.⁷ When the line switch is closed, the condenser C begins to charge and the tube remains non-conducting until the condenser voltage, and hence the anode voltage, increase enough to cause breakdown. The condenser then discharges very rapidly to the arc-drop potential. The inductance L , however, forces the current to continue because of the voltage induced by the falling flux. Consequently, the condenser changes polarity and the arc is extinguished. As soon as the tube becomes non-conducting, the supply voltage again builds up a charge in the condenser, and the entire cycle is repeated.

Sufficient time must be allowed during the commutating period for the tube to deionize; otherwise the inversion will stop, and the tube will pass a steady current limited only by the series resistance.

Ordinarily, this circuit does not lend itself to large power applications because the high peak current through the tube soon limits the permissible power input. The frequency is controlled readily by changing C , E_g , or R .

A modification of this circuit is used extensively for linear timing bases for oscillograph work, but its most important application is as a timing device for other circuits. For this, the output voltage, peaked by a transformer, is used to start high-power tubes at regular, controllable intervals for welding machines, etc.

Gas- or vapor-filled tubes are very valuable for controlling resistance welders. The a-c control system shown in Fig. 78 can be adapted to this use or the current to the primary of the welding transformer can be supplied directly through pool tubes using the circuit of Fig. 81. Two pool tubes are connected in opposition so that both half cycles of current can be supplied to the welding transformer. The pool tubes are fired with immersed ignitors which draw power from the line through separate grid-controlled, mercury-vapor-filled tubes. These tubes in turn are controlled by timing circuits, which are adaptations of the single-tube inverter, to

give the required welding performance. In this way, the current delivered to the weld can be limited to a definite number of cycles for spot welds or may be made to give a large variety of welding cycles for continuous seam welds.

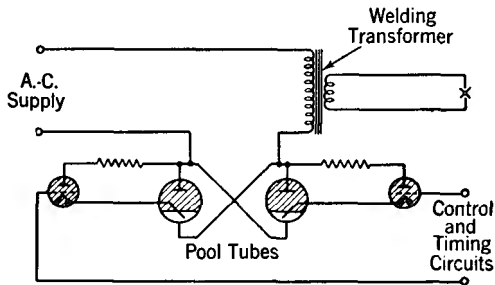

FIG. 81. The use of pool tubes for controlling the flow of alternating current to a welder. The pool tube ignitors are energized by grid-controlled, hot-cathode tubes.

These examples illustrate a few of the ways in which gas- or vapor-filled tubes are being applied to industrial problems. Many more uses are being found for these tubes as engineers become better acquainted with them.

BIBLIOGRAPHY

1. Voltage Impulses for Thyatron Grid Control, M. M. MORACK, *General Electric Review*, June, 1934.
2. Photoelectric Relays, W. R. KING, *General Electric Review*, August, 1932.
3. Applications of Electron Tubes in Industry, D. E. CHAMBERS, *Electrical Engineering*, January, 1935.
4. *Electron Tubes in Industry*, K. HENNEY, McGraw-Hill Book Co., 1934.
5. *Industrial Electronic Control Applications*, F. H. GULLIKSEN and R. N. STODDARD, *Electrical Engineering*, January, 1935.
6. *Grid Controlled Rectifiers and Inverters*, C. C. HERSKIND, *Electrical Engineering*, June, 1934.
7. *The Single Tube Thyatron Inverter*, O. W. LIVINGSTON and H. W. LORD, *Electronics*, April, 1933.

ADDITIONAL REFERENCES

Vacuum Tube Controlled Rectifiers, C. B. FOOS, *Electrical Engineering*, April, 1934.

The Thyatron Relaxation Oscillator and Its Applications, H. T. REICH, *Review of Scientific Instruments*, October, 1933.

Thyatron Control for Resistance Welding Machines, S. S. MARTIN, *Welding*, May and June, 1932.

A Study of the Thyatron Commutator Motor, C. H. WILLIS, *General Electric Review*, February, 1933.

New Vacuum Valves and Their Applications, A. W. HULL, *General Electric Review*, December, 1932.

Thyatron Motor, E. F. W. ALEXANDERSON and A. H. MITTAG, *Electrical Engineering*, November, 1934.

Constant Current D. C. Transmission, C. H. WILLIS, B. D. BEDFORD and F. R. ELDER, *Electrical Engineering*, January, 1935.

CHAPTER IX

SPECIAL TUBES

The tubes which have been considered so far were designed for general-purpose use. The same electronic principles can be applied to produce tubes to meet special requirements. Two of these tubes are adapted for measurement work and were described in an earlier chapter. They are the low-grid-current tube shown in Fig. 38 and the low-noise tube in Fig. 39.

49. Cathode-ray oscillograph tube. In the cathode-ray oscillograph tube,¹ electronic phenomena are utilized in a somewhat different way. This oscillograph tube, shown in Fig. 82, is a high-vacuum tube having at one end a cathode

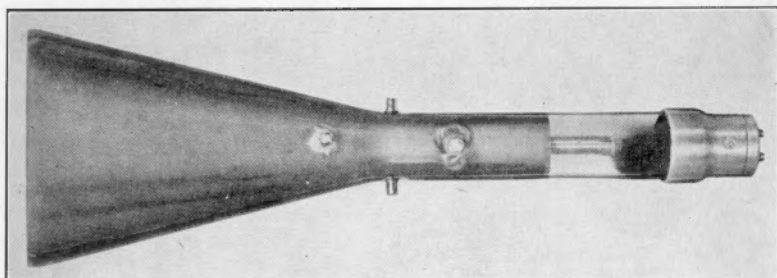

FIG. 82. A cathode-ray oscillograph tube.

enclosed in a cylindrical chamber. One end of this chamber is made up of two metallic members, one of which is a grid and the other a disc which serves as an anode.

In operation, high-speed electrons are ejected from a small hole in the anode disc and form a pencil or ray of electrons. This ray is further focused by an additional focusing cylinder, after which the electron beam traverses the length of the tube and falls on a fluorescent screen that emits

light from the area upon which the beam falls. The tube is also equipped with two sets of deflecting plates which are placed perpendicular to the axis of the tube and to each other. If a potential difference is established between a pair of these deflecting plates, the beam will be deflected in the direction of the more positive plate. This deflection will be communicated in a magnified form to the fluorescent screen.

The beam may also be deflected by mutually perpendicular magnetic fields from coils outside of the tube. Magnetic deflection is particularly useful sometimes in studying current variations. The deflection of the beam in the vertical and horizontal directions is exactly similar to plotting points on Cartesian (rectangular) coordinate cross-section paper. The fluorescent trace may be made to follow the curve resulting from the simultaneous influence of two variables and, therefore, to show the relation between such variables. It is chiefly used for recurrent phenomena, but transient phenomena may be recorded by photographing the trace. Many complicated phenomena can be studied with great ease by supplying the horizontal deflecting plates with a voltage which varies linearly with time.²

One way of obtaining a linear time base is to use a single-tube inverter. The condenser should be charged at a constant current rate through an emission-limited diode or through a pentode and discharged through a paralleled, grid-controlled, gas-filled tube. The voltage across the condenser will rise linearly with time and fall very rapidly to zero when it is discharged. The voltage drop should be applied across the horizontal deflecting plates. The timing frequency is controlled by the size of the capacity and the charging rate.

The inertia of the electron beam is extremely low, and, therefore, can follow faithfully the deflecting force due to rapidly changing impulses applied to the deflecting plates.

For this reason, and because the deflecting plates add practically no impedance to the test circuit, the oscillograph

tube is an extremely powerful tool and is almost a necessity in the study of voltage and current wave shape in alternating-current circuits above 500 cycles. By adjusting the frequency of the time-base generator, the voltages on the two sets of deflecting plates can be synchronized and the trace on the oscillograph screen will then be a stationary curve plotted with time for the abscissa.

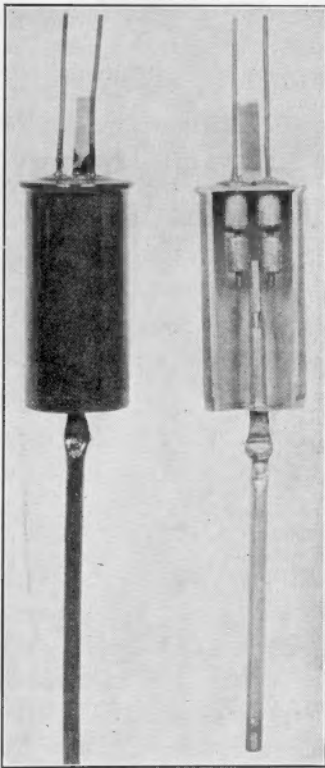

FIG. 83. A single-pole, double-throw vacuum switch.

50. Vacuum switches.³ When a switch is opened in air, the current flow does not stop at once but continues to flow through a spark or arc at the contact points. For small currents in non-reactive circuits, the sparking may be minute; but for larger currents, an arc may develop which burns the contacts and in some cases may not extinguish itself. This difficulty can be reduced considerably by breaking the circuit in an evacuated chamber. There is less tendency to arc because the ionizable medium (air) has been removed. Fig. 83 shows one type of vacuum switch which contains a single-pole double-contact switch.

The container is a steel cylinder closed at one end by a flexible diaphragm. A rod carrying the movable contact penetrates the diaphragm so that the contact may be closed from the outside. Very little motion is needed to open the circuit, and little pressure to give a low-resistance contact.

This particular switch has a rating of 10 amperes and

250 volts alternating or 10 amperes and 125 volts direct current.

51. Barkhausen-Kurtz oscillators.⁴ Another special form of high-vacuum tube is shown in Fig. 84. This tube when used in conjunction with appropriate circuits is capable of generating low-power oscillations in the frequency band between 600 and 1700 megacycles per second.

This result is accomplished by using the tube as a brake-field oscillator. Oscillations are obtained by applying a high positive voltage to the grid. Electrons leave the cathode in an accelerating field that is due to the grid, but, because the grid is an open structure, many of the electrons penetrate into the grid-anode region. The electric field in this region reduces the electron velocity to zero at some point near the anode. From this point the electrons are again accelerated toward the grid and again some electrons pass through into the grid-cathode space. The to-

and-fro motion of some of the electrons is in the proper phase to build up oscillations in a tuned circuit connected between plate and grid. For these very short wavelengths, the tuned circuit is usually a transmission line short-circuited by a reflector at a distance of one-quarter wavelength from the tube. The rate at which these pulsations occur depends on the transit time of the electrons and, therefore, on the length

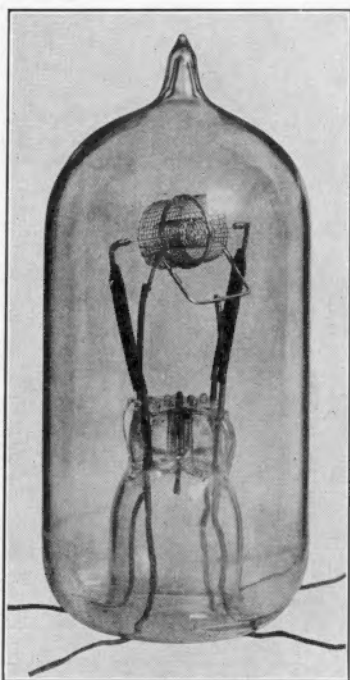

FIG. 84. A three-electrode, high-vacuum tube used for producing oscillations of the Barkhausen-Kurtz type.

of electron path, that is, anode diameter and accelerating voltage. Consequently, the frequency of oscillations is determined almost entirely by the tube dimensions and the applied voltage rather than circuit resonance. The efficiency is low — of the order of 5 per cent — and the power output is consequently small.

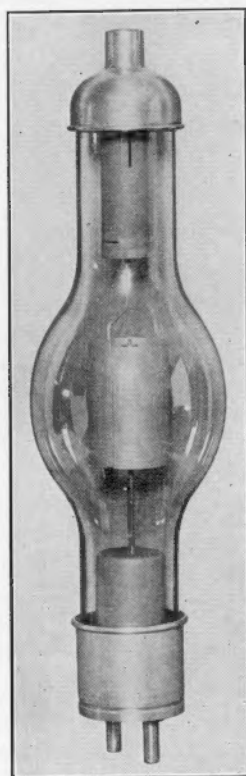

FIG. 85. A two-electrode, high-vacuum tube designed for high-voltage rectifier service.

This tube is used as a generator⁵ of ultra-high-frequency oscillations to aid the study of many phenomena, such as the chemical and biological effects occurring in the high-frequency electrostatic or electromagnetic field, or the reflection, refraction, and absorption of quasi-optical waves.

52. High-voltage rectifier tubes. Fig. 85 shows a high-vacuum, two-electrode tube designed for high-voltage rectification. This tube has a tungsten filament and is cooled by radiation. It may be used in any rectifier circuit so long as the ratings are not exceeded. The tube is very well exhausted and is provided with shields over the glass stems to prevent puncture.

The maximum voltage rating can be utilized only with the tube immersed in oil. When this precaution is taken, it may be used in rectifier circuits up to 125,000 volts. Extremely high-voltage rectifiers of this type are used to supply power for cable testing, X-ray apparatus, and smoke-precipitation equipment.

BIBLIOGRAPHY

1. A New Cathode-Ray Oscillograph Tube, G. F. METCALF, Electronics, May, 1932.
2. Linear Time Axis for a Cathode-Ray Oscillograph, A. L. SAMUEL, Bell Laboratory Record, August, 1931.
3. A New Vacuum Switch, A. J. KLING, General Electric Review, November, 1935.
4. The Barkhausen Oscillator, F. B. LEWELLYN, Bell Laboratory Record, August, 1935.
5. Investigations in the Field of Ultra-Short Electromagnetic Waves, G. POTAPENKO, Physical Review, February, June, and July, 1932.

CHAPTER X

THE CONSTRUCTION OF ELECTRON TUBES

So far, we have confined our attention almost entirely to the electrical properties of electron tubes. The mechanical features are equally important if the tube is to perform its allotted task over a long period of time.

Apart from purely electrical design requirements, the need for freeing the tube of unwanted gases and keeping it free probably has had more effect on tube design than any other one thing. There are many reasons for maintaining the lowest practicable pressure of residual gases. Most gases are injurious to thermionic cathodes either because of the mechanical destruction due to ion bombardment or the increase in effective work function and consequent reduction in emission. This does not mean that all the gas must be removed — which is impossible — but, in general, the residual pressure of foreign gas in a high-vacuum tube must be of the order of 0.01 micron or less. In gas- or vapor-filled tubes, the requirements are equally rigorous, and the residual gas pressure should be kept to a low value; it seems probable that the gas-filled tubes cannot tolerate any more residual gas than high-vacuum tubes can.

In a high-vacuum tube, the residual gas may interfere with the space-charge control of the plate current and give erratic characteristics. Focused positive-ion bombardment in high-voltage tubes is capable of melting glass or metal parts and so ending the life of the tube.

One link between the destructive effects of gas and tube design is the fact that all the parts which go into the tube contain gas imbedded within the material as well as on the surface. The pumping or exhaust process is designed to remove any gas which might otherwise be liberated during operation.

Residual gases, particularly oxygen-bearing gases, are destructive to barium-coated cathodes. They must be driven out of the tube walls and parts and pumped out. This is true of any kind of tube whether high-vacuum or filled with mercury vapor.

Another condition imposed by the gas-pressure requirement is that the tube envelope must not leak. The components of the tube must meet many other demands, which will be discussed as they arise.

53. The tube envelope. The tube envelope must be made of a material which can withstand air pressure, be vacuum tight, and provide support for the internal parts. Most substances can be freed of gas only by heating to high temperatures — 400°C to 500°C for glass and 800°C to 900°C for metals — and, therefore, the envelope must perform its various duties even at these high temperatures.

The materials which are commonly used are glass, steel or iron alloys, and copper. Some envelopes are made entirely of glass, and others entirely of steel. High-voltage, water-cooled tubes such as are used in radio transmitters have a tubular copper anode which is part of the vacuum chamber and a glass bulb sealed to the open end to complete the vacuum chamber, provide insulation between leads, and support the internal elements.

Leads are made to the internal electrodes in several ways. Metal-to-glass seals can be made vacuum tight only by heating the glass so hot that it flows onto the metal and wets it much the same as solder wets a clean metal surface. All electron tubes use these metal-to-glass seals to introduce leads into the vacuum chamber. The mechanical design of the seals must be such that they can withstand the internal strain set up by expansion or contraction due to temperature changes. Seals made between tungsten, molybdenum, or copper and glass require careful design to prevent cracking because the thermal expansion coefficients of these materials are quite different.

A specific alloy of iron, nickel, and cobalt which has an

expansion coefficient equal to that of certain glasses over a wide temperature range is often used. Seals made with this combination are relatively free from internal strain after annealing and can be made in a wide variety of forms. All

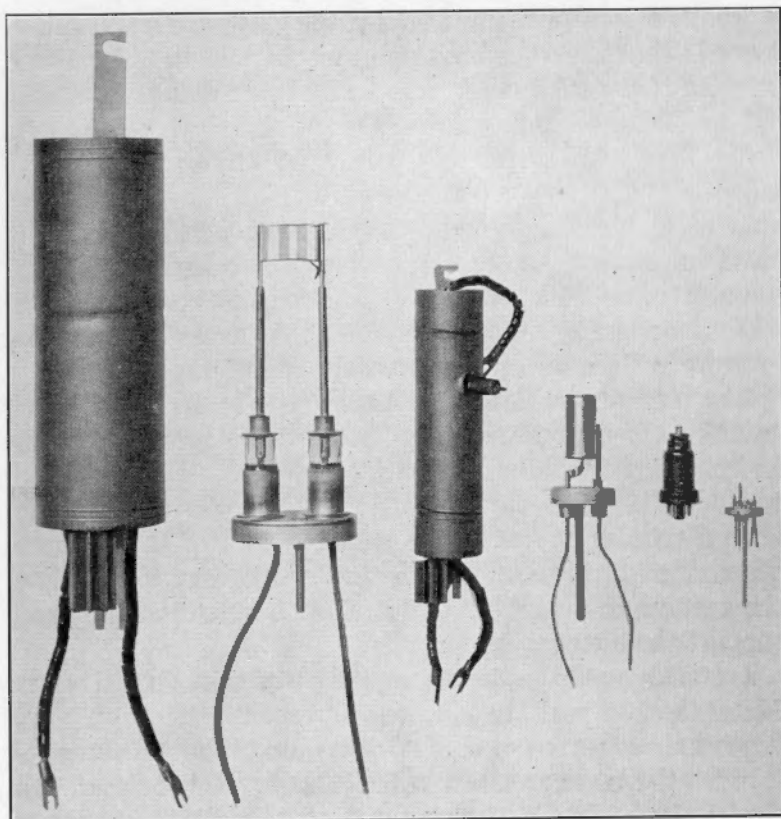

FIG. 86. A group of metal tubes showing the internal structure. At the left is a two-electrode, mercury-vapor tube and cathode header; next, is a shield-grid, mercury-vapor tube and cathode mount and, at the right, a receiving tube and cathode header.

the seals for the tubes shown in Fig. 86 use this alloy in various shapes.

Pillar seals, such as are shown at the left of Fig. 86 are made of a hat-shaped punching of iron alloy with an inner

and an outer lead welded to the top. A glass cylinder long enough to give the required insulation is sealed to the brim of the hat by setting the glass on the metal flange and heating the junction until the end of the glass cylinder melts and flows onto the metal. The other end of the glass is sealed to the flange of another alloy punching. The bottom of this last punching fits around a hole in a steel punching which is to be the end of the tube. A vacuum-tight joint is made between the punching and the steel header by welding with resistance welders controlled by mercury-vapor-filled tubes. Similarly, the steel header is welded into the steel tubing which is to form the side walls of the tube.

Steel high-vacuum tubes for radio receivers, Fig. 88, use somewhat similar seals. In this case, an iron alloy eyelet, open at both ends, is welded or brazed to the header. A lead wire of the same metal is first wet with a small bead of glass and then inserted in the eyelet. The glass bead is then melted down so that a vacuum-tight seal is formed between the lead wire and the eyelet. Here, also, the component steel parts are joined by controlled welders.

Fig. 87 shows a high-vacuum, water-cooled tube used in high-frequency radio transmitters. A copper-to-glass seal joins the copper anode to the glass bulb, and a smaller copper seal is used for the grid lead on the side. The cathode leads are tungsten and are sealed directly into the glass in the tube axis.

Leads for tubes with glass envelopes are sealed in by first beading the leads and then sealing the beaded leads into a glass pinch. The pinch, so called, is made by pinching the heated end of a glass cylinder down around the beads and fusing the whole mass of glass into one unit.

The envelope is provided with a pipe called the exhaust tube, of metal or glass as the case may be, by which the tube is connected to the pumping system. When the exhaust is complete, this tube is closed off and the tube removed from the pumps.

It is apparent that most of the design is dictated by the

need for an envelope which is not only vacuum-tight but which will retain its mechanical form and strength even when it is heated to a high temperature to drive out the gas.

54. Cathodes. We have discussed cathode structures at some length in an earlier chapter and need add but little here. It is obviously necessary to properly support any

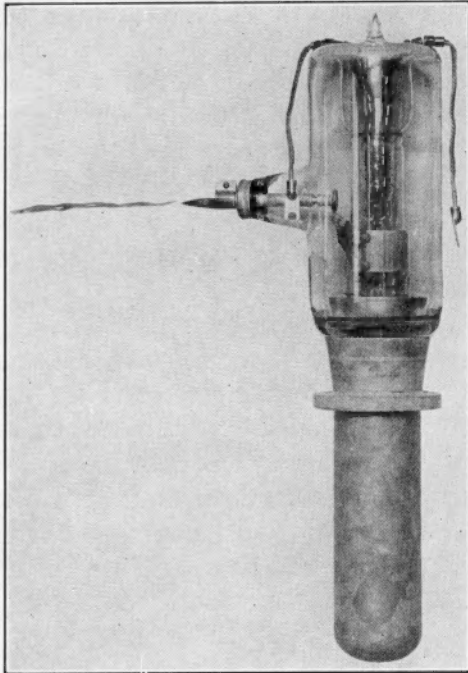

FIG. 87. A water-cooled, high-vacuum tube. The metal anode, which is part of the evacuated container, is joined to the upper glass cylinder by a vacuum-tight seal.

cathode structure to prevent the distortion which may occur at high temperatures. High-temperature filaments require support materials such as tungsten or molybdenum which are strong at elevated temperatures. Insulators, if any are used, must be refractory materials or quartz.

55. Anodes. The primary function of the anode is the collection of the electron current. While performing this

duty, it is also being heated by electron impact, and it must be so designed that it can lose this heat without a dangerous temperature rise. In glass tubes, the anode is cooled almost entirely by radiation. It is necessary to select metals which can be operated continually at temperatures between 300°C and 700°C . The metals ordinarily used are molybdenum, nickel, or iron. The radiation loss is frequently increased by adding fins to increase the radiating area as well as to strengthen the structure, by roughening the surface, and by blackening the surface to increase the thermal emissivity.

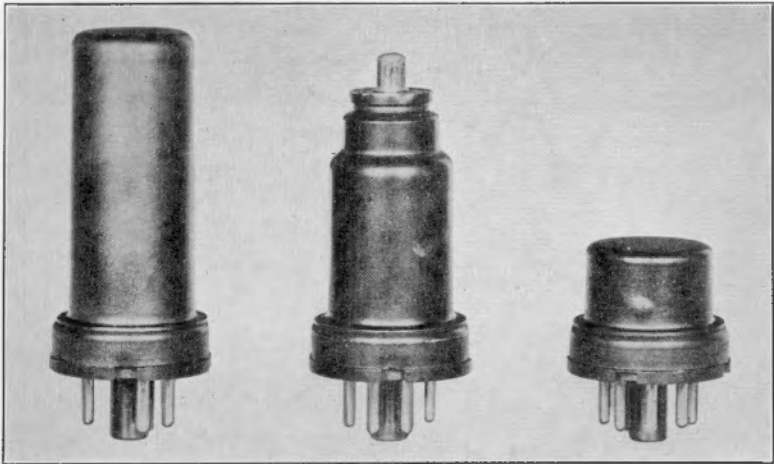

FIG. 88. Group of receiving tubes built in steel envelopes.

Graphite is widely used because it is easily worked and has a high thermal emissivity and high melting point. The permissible dissipation from radiation-cooled anodes is about 5 to 10 watts per square inch.

A considerable portion of the heat radiated by the anode is absorbed by the glass bulb, and it also must be cooled. Usually, air convection is sufficient, but in extreme cases, the cooling is increased by blowing air on the tube. If the tube has a steel shell instead of glass, all the radiated heat is absorbed by the tube walls, but again air cooling by natural or forced convection is ordinarily sufficient.

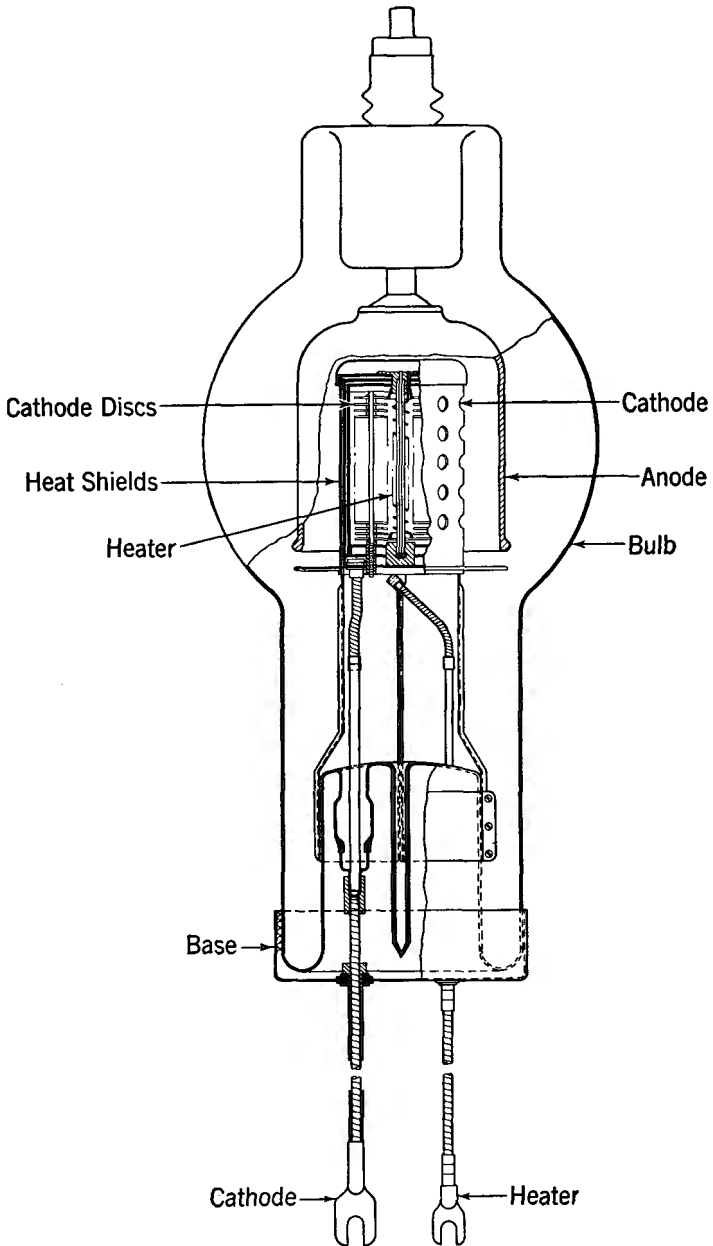

FIG. 89. Cross section of a mercury-vapor filled, two electrode tube for high-voltage rectifier service.

For high-power, high-vacuum tubes like the one shown in Fig. 87, the anode is purposely made part of the tube wall so that it can be water-cooled. The tube is used in conjunction with a water jacket which permits water circulation past every part of the anode. This method of cooling permits the dissipation of 250 to 350 watts per square inch of anode surface.

56. Grids. The control electrodes must be made accurately of materials which will not deform during exhaust or use if the tube characteristics are to remain constant. Consequently, it is necessary to use metals such as tungsten, molybdenum, tantalum, or nickel. In high-vacuum tubes, the grid wire is either woven into mesh of the proper dimensions or wound on support rods to which the turns are bound or welded. In gas- or vapor-filled tubes, grids are usually made of perforated sheet nichrome. In some cases, part of the grid is made of graphite.

In any event, the grid must be held rigidly with respect to the other electrodes to prevent erratic characteristics. Since grids are cooled almost entirely by radiation, they usually are given a black, rough surface.

57. Exhaust. After the tube is completely assembled, it must be pumped out. The tube is connected to the pumping system and the air is pumped out. If the envelope is glass or partly glass, the whole tube is baked in an oven. This liberates a large amount of gas, particularly water vapor, from the tube walls and the electrodes. Steel tubes may either be baked in ovens or heated with induction furnaces. The electrodes are heated either by electron bombardment or with induction furnaces. The cathode treatment depends on the kind of cathode which is used.

After all the electrodes are thoroughly degassed, the tube is sealed-off and is then ready for test.

APPENDIX

VALUES OF β^2 AS A FUNCTION OF THE RADII

r_0 = radius of cathode.
 r = radius of anode.

β^2 applies to case where $r > r_0$.
 $-\beta^2$ applies to case where $r_0 > r$.

r/r_0 or r_0/r	β	$-\beta^2$	r/r_0 or r_0/r	β^2	$-\beta^2$
1.00	0.0000	0.0000	3.8	0.6420	5.3795
1.01	0.00010	0.00010	4.0	0.6671	6.0601
1.02	0.00039	0.00040	4.2	0.6902	6.7705
1.04	0.00149	0.00159	4.4	0.7115	7.5096
1.06	0.00324	0.00356	4.6	0.7313	8.2763
1.08	0.00557	0.00630	4.8	0.7496	9.0696
1.10	0.00842	0.00980	5.0	0.7666	9.887
1.15	0.01747	0.02186	5.2	0.7825	10.733
1.20	0.02815	0.03849	5.4	0.7973	11.601
1.30	0.05589	0.08504	5.6	0.8111	12.493
1.40	0.08672	0.14856	5.8	0.8241	13.407
1.50	0.11934	0.2282	6.0	0.8362	14.343
1.60	0.1525	0.3233	6.5	0.8635	16.777
1.70	0.1854	0.4332	7.0	0.8870	19.337
1.80	0.2177	0.5572	7.5	0.9074	22.015
1.90	0.2491	0.6947	8.0	0.9253	24.805
2.0	0.2793	0.8454	8.5	0.9410	27.701
2.1	0.3083	1.0086	9.0	0.9548	30.698
2.2	0.3361	1.1840	9.5	0.9672	33.791
2.3	0.3626	1.3712	10.0	0.9782	36.976
2.4	0.3879	1.5697	12.0	1.0122	50.559
2.5	0.4121	1.7792	16.0	1.0513	81.203
2.6	0.4351	1.9995	20.0	1.0715	115.64
2.7	0.4571	2.2301	40.0	1.0946	327.01
2.8	0.4780	2.4708	80.0	1.0845	867.11
2.9	0.4980	2.7214	100.0	1.0782	1174.9
3.0	0.5170	2.9814	200.0	1.0562	2946.1
3.2	0.5526	3.5293	500.0	1.0307	9502.2
3.4	0.5851	4.1126	∞	1.000	∞
3.6	0.6148	4.7298			

INDEX

- Activation, of barium coating, 34**
 of thoriated wire, 31
Ampere, 6
Amplification factor, 61
Amplifiers, audio frequency, 87
 class A, 89
 class B, 91
 class C, 92
 current, 86
 load resistance, 86
 power, 86, 87
 radio frequency, 87
 voltage, 86
Amplitude control, 143
 circuits for, 144
Ångström unit, 40
Anode, construction of, 164
 definition of, 23
 heat losses at, 47, 117, 165, 167
 material for, 165
Arc drop, 110
 in argon-filled tube, 127
 in mercury-vapor tube, 110
Arc extinction, 121, 122
Arc formation, 106
Archeback, 118
Argon-filled tube, arc drop in, 127
 characteristics of, 127, 135
Atom, 1
 excitation of, 110
Audio frequency, 87
 amplifier, 87

Barium-coated cathode, 33
 activation of, 34
 disintegration of, 116
 emission efficiency of, 36
 heat shielding in, 34
 structure of, 33, 162, 166
 temperature, 35
Barkhausen-Kurtz oscillator, 157

Bias voltage, 86, 143
Bibliography, see Preface
 atoms and electrons, 7
 electron emission, 49
 gas or vapor-filled tubes, 139, 152
 application of, 153
 gases, 17
 high-vacuum tubes, 79
 applications of, 99
 space-charge, 49
 special tubes, 159
Bohr, N., 2
Boltzmann, L., 9
Boltzmann constant, 9
Boltzmann equation, 9
Breakdown, current required for, 106
 effect of gas pressure on, 107
 in three-electrode tube, 127

Cathode, 21, 28
 barium-coated, 34
 construction of, 19, 29, 34, 164
 heat-shielded, 118
 mercury-pool, 137
 photosensitive, 50
 thoriated tungsten, 31
 tungsten, 29
Cathode drop, 115
Cathode-ray oscillograph tube, 154
Cathode sheath, 109, 114
Characteristics, argon-filled tube, 127
 dynamic, 80
 magnetic control, of high-vacuum tube, 76
 of gas-filled tube, 128
 negative-grid tube, 124
 pentode, 73
 positive-grid tube, 124
 screen-grid tube, 70
 shield-grid tube, 134

- Characteristics, static, 62
 temperature effect on, 109, 125
 transfer, 62
 Charge, electron, 1
 of ion, 103
 Child, C. D., 46
 Class A amplifier, applications of, 89
 distortion in, 90
 dynamic characteristic, 90
 power output, 90
 Class B amplifiers, application of, 92
 current and voltage relation, 91
 distortion in, 92
 power output, 92
 Class C amplifiers, 92
 current and voltage relation, 93
 dynamic characteristic, 92
 Class C oscillator, 93
 Coated cathode, 33
 activation of, 34
 construction of, 29, 34, 169
 disintegration of, 116
 emission efficiency, 34, 36, 118
 heat loss from, 35
 ion bombardment, effect of, 116
 Compton, K. T., 137
 Condensation point, 108
 Condensation temperature, 109
 Conduction period, gas-filled tube,
 142
 high-vacuum tube, 88-92
 Constant current characteristics, 62,
 68
 Control, gas-filled tubes, 142
 amplitude, 143
 circuit elements for, 144
 magnetic, 146
 phase shift, 144
 saturable reactor, 148
 Control ratio, 123
 Controlled rectifier, 146
 Critical potential, 14
 Current density, anode, 111
 random, 12, 110
 Cut off, 60

 Deionization time, 119, 122
 Diode, applications of, 56
 Diode, equivalent, 60
 Double sheath, current flow in, 114,
 115
 potential distribution in, 114
 Du Bridge, L. A., 40
 Dushman, S., 27
 Dushman's equation, 27
 Dynamic characteristics, 80
 class A, 90
 class B, 91
 class C, 92
 curvature in, 82

 Edison, T. A., 23
 Edison effect, 23
 Effective filament area, 61
 Einstein, A., 39
 Electric field, in gas-filled tubes, 105,
 125
 in high-vacuum tubes, 42, 60
 Electrical conduction, 4
 Electron, charge of, 1
 mass of, 1
 mean free path, 11
 orbits, 2
 sheath, 113
 speed, 5
 trapping, 104
 Electron emission, 25
 Electron tube, construction of,
 160
 envelope for, 161
 Emission, barium, 34
 field, 37
 grid, 132
 photoelectric, 38
 secondary, 64, 71
 thorium, 31
 tungsten, 29
 Emission efficiency, barium, 36
 thorium, 33
 tungsten, 30
 Equivalent diode, 60
 Evaporation, 13
 Excitation, atomic, 13, 110
 Excited atoms, ionization of, 110
 Exciting voltage, 86
 Exhaust, 47, 167

- Feedback, 88
 Fever, high frequency for, 98
 Field emission, 37
 in cathode sheath, 115
 Filament, effective area of, 61
 Fleming, J. A., 23
 Found, C. G., 115
 Frequency effect in gas-filled photo-
 tubes, 55

 Gas, density of, 9
 occluded, 48, 160
 pressure, 9, 160
 Gas-filled phototubes, 53
 amplification in, 54
 frequency effect in, 55
 Gas-filled tubes, 21, 100
 anode current density, 111
 anode power loss, 117
 arc formation in, 101, 104
 control ratio, 123
 grid control of, 121
 negative-grid type, 123
 plasma in, 107
 positive grid type, 123
 potential distribution in, 105
 precautions in use of, 116
 pressure in, 100
 sheaths in, 107, 111
 structure of, 120
 three-electrode type, 120
 two-electrode type, 117
 Getter, 48
 Grid control, of gas-filled tube, 120
 of high-vacuum tube, 59
 Grid construction, 167
 Grid current, gas-filled tube, 130
 in high-vacuum tube, 64, 95
 in shield-grid tube, 133
 tube with low, 84
 Grid emission, 132

 Heat shield, 33
 High-frequency fever, 98
 High-vacuum tube, 21
 amplifier, 87-92
 characteristics of, 62, 70, 73, 76, 80
 construction of, 19, 164

 High-vacuum tube, five-electrode, 73
 four-electrode, 68
 grid current in, 64, 95
 plate loss in, 47
 potential distribution in, 42, 60
 space charge in, 41
 special, 84, 85, 154
 three-electrode, 59, 74
 two-electrode, 50
 High-voltage tube, 158
 Hull, A. W., 116

 Ignitor, pool tube, 138
 Immersed ignitor, 139
 Initial velocity, 27, 44
 Internal-grid tube, characteristics of,
 75
 construction of, 74
 Inverse voltage, 57, 119
 Inverter, 149
 single-tube, 150
 Ion, 14
 charge of, 103
 losses in arc, 113
 positive, 14
 recombination of, 113
 Ionization, 13, 47
 of excited atoms, 110
 of metastable atoms, 110
 of neutral atoms, 13, 47
 probability of, 16, 106
 time, 122

 Lamar, E. S., 137
 Langmuir, I., 46, 103, 104, 112
 Load resistor, action of, 81, 102
 Long wave limit, phototube, 40
 Loss of control, 121
 Low grid-current tube, 84
 Low noise tube, 85
 Ludwig, L. R., 139

 Magnetic control, of gas-filled tubes,
 128, 129, 146
 of high-vacuum tubes, 76-78
 Mass, of atom, 1, 115
 of electron, 1
 Mean free path, 10

- Mercury, vapor pressure of, 108
 Metal tube, 162, 165
 Metastable atom, 13
 ionization of, 110
 Modulation, 97
 Molecule, 4
 Mott-Smith, H. M., 112
- Negative-grid tubes, 124
 Nucleus, 2
- Occluded gas, 160
 Ohm's law, 6
 Oscillator, Barkhausen-Kurtz, 157
 class C, 93
 uses of, 95
 Oscillograph, cathode-ray tube for, 154
- Pentode, 73
 Phase-shift control, 143
 Photoemission, 39-41
 Phototube, cathode for, 50
 characteristics of, 52-54
 gas-filled, 53
 long wave limit, 40
 relay, 147, 148
 sensitivity, 52
 Planck, M., 3
 Planck's constant, 3
 Plasma, 107
 function of, 109
 glow in, 111
 ion density in, 107
 ion flow in, 111
 Plate, 60
 characteristic, 62
 resistance, 66
 Pool tube, 135
 cathode for, 137
 immersed ignitor for, 139
 rating, 138
 starter for, 139
 Positive-grid tube, 124
 Positive ion, 14
 current, 114
 recombination of, 113
 sheath, 112
- Positive space charge, 103
 Potential distribution, in gas-filled tube, 105
 in high-vacuum tube, 42, 60
 in plasma, 105, 107
 in sheath, 112, 113
 Potential maximum, 104
 Potential minimum, 44
 Pressure, 10
 in gas-filled phototubes, 53
 in gas-filled tube, 100
 in high-vacuum tube, 160
 mercury vapor, 108
 Probability of ionization, 16, 106
 Probe characteristics, 112
- Radio frequency, 87
 reception, 96
 transmission, 96
 Random current density, 12, 110
 Recombination of ions, 113
 Rectifier, 56
 circuits for, 57
 controlled, 146
 Resistance welder, 151
 Richardson, O. W., 26
 Richardson's equation, 26
 Root-mean-square velocity, 8
- Saturable reactor, control with, 148
 Schottky effect, 27, 36
 Screen-grid tube, 70
 characteristic, 70
 current in, 72
 feedback, 88
 Seals, metal to glass, 161
 pillar, 162
 Secondary emission, 38
 effect on characteristics, 64, 71
 Selenium tube, 55
 Sheath, 107, 111
 cathode, 114
 current flow in, 112
 electron, 113
 positive ion, 107
 thickness of, 113
 Shield-grid tube, 132
 characteristics of, 134

- Shield-grid tube, grid current in, 133
Slepian, J., 139
Space charge, 41, 59
 current limit, 45, 115
 effect of gas on, 102, 103
 equation, 46
 grid, 69
 in sheath, 112
Sputtering, 116
Starter, pool tube, 139
Static characteristic, 62
Suppressor grid, 73

Tank circuit, 93
Temperature, cathode, 26, 29, 31, 35
 condensation, 109
 effect on characteristics, 109, 125
 exhaust, 161
Tetrode, *see* Screen-grid tube

Thomson, J. J., 5
Thoriated emission, 31, 33
Transconductance, 66
Transfer characteristic, 62
Triode, 59
Triode equations, 60
 limitations of, 65
Tungsten emission, 29-30
Two-electrode tube, gas-filled, 117
 high-vacuum, 23, 56

Vacuum switch, 156
Vacuum-tube voltmeter, 83
Vapor pressure, mercury, 108

Water-cooled tube, 163
Welder, resistance, 157
Work function, 26, 28
 photoelectric, 40