

FRANK C.

Jones

Antenna

Handbook



FIFTY CENTS

1937

Jones

Antenna Handbook

By
Frank C. Jones

1937
EDITION

Published by Frank C. Jones
and distributed by
Pacific Radio Publishing Company, Inc.
Post Office Box 3278 . . . San Francisco, California

Contents

Antenna Theory

	Page
Angle Radiation	10
Antenna Impedance	9-14
Broadside Radiation	10
Choice of Antennas	12
Counterpoise	9
Directional Properties	10
Directive Factors	31
Electrical Properties	8
End-Fire Radiation	10
Fading Effects	8
Ground Reflection Patterns	12
Ground Wave	7
Harmonic Antennas	11
Horizontal and Vertical Directivity	31
Horizontal Half Wave Antenna Radiation Patterns	10
Induction Field	7
Kennelly-Heaviside Layer	8
Long Horizontal Antenna Patterns	13
Polarization	31
Radiation Field	7
Radiation Resistance	9
Receiving Antenna Theory	51
Reflectors and Directors	31-32
Skip Distance	10
Space Limitations	27
Standing Waves	8
Theory of Hertz and Marconi Antennas	12
U. H. F. Antenna Theory	47-38
Vertical Antenna Radiation Patterns	11

Antennas For Transmitting

Center Fed Zepp	23
Collins Multi-Band Antenna	20
End Fed Antenna	25
End-Loaded Half Wave Antenna	27
Impedance Matching Stubs	17-18
Johnson "Q"	19
Long Single Wire Antenna	26
Mast Construction	57
Single Wire Fed	14-15-16-17
Twisted Pair Fed Antenna	26
Two Band Tilt Antenna	44
Two Half Wave Antennas in Phase	18
Two Wire Matched Impedance Antenna	24
Zepp. Antenna	21-22
160 Meter Marconi Antennas	29

Directional Antennas

Barrage Antenna	36
Beverage Antenna	39
Bruce Antenna	34
Chireix-Mesny Antenna	37
Diamond Antennas	38-39
Directors	32
Franklin Antenna	33
Horizontal and Vertical Directivity	31
RCA Broadside Antenna	36
Reflectors	31

	Page
Stacked Dipole Antennas	35
Theory of Directional Antennas	30
Two-Band Tilt Antenna	44
Two Half Wave Antennas in Phase	18
"V" Antenna Design Table	37
"V" Antennas	37-38-39
Yagi Antenna	32

Antennas For Receiving

Belden Off-Center Doublet	54
Doublet Antennas	51-52
General Electric "V" Doublet Antenna	54
McMurdo Silver R9 Antenna	55
Philco All Wave Antenna	53
RCA RK-40 Antenna	54
RCA Spider-Web Antenna	53
RCA World-Wide Antenna	52

Antennas For Ultra-High-Frequencies

Chart for Antenna Array Dimensions	34
Chart for Reflector and Director Dimensions	34
Micro-Wave Antennas	49
Mobile U.H.F. Antennas	48
Reinartz Rotary Beam Antenna	51
2½ Meter Antennas	34-49-50
5 Meter Antennas	47-48-49
10 Meter Vertical Antenna	19

Special Purpose Antennas

Aircraft Antennas	56
Auto Antennas	55
Dummy Antennas	44-45
Loop Antennas	57
Marine Antennas	57
Two Band Tilt Antenna	44
10 and 20 Meter Antennas	18-19

160-Meter Antennas

Marconi Antennas	29
160-Meter Antenna Coupling Systems	28

Antenna Coupling Systems

Antenna Coupling Methods	41
Collins PI Coupler	41-42
Concentric Lines	50
Faraday Screen	56
Inductive Coupling	41
Link Coupling	42-43
Simplified PI Coupler	28
160 Meter Coupler	28

Antenna Charts

Antenna Array Dimensions	34
Collins All-Band Antenna	21
Half Wave Antenna Lengths	27
"V" and Diamond Charts	38-39
"V" Antenna Lengths	37
Zepp. Feeder Lengths	23

Measuring Equipment

Field Strength Measuring Set	45
Standing-Wave Detector	46

**This Is The First of a Series
of Frank C. Jones Publications.**

Other Books by the same Author are:—

JONES RADIO HANDBOOK

1937 Edition



JONES ULTRA-HIGH FREQUENCY HANDBOOK

1937 Edition



"AMATEUR RADIOTELEPHONY"

A Comprehensive Book for 'Phone Men



"THE RADIO AMATEUR NEWCOMER"

A Book for Beginners



Introduction

THE aim of **The Jones Antenna Handbook** is to provide practical guidance in the selection and construction of that type of equipment which is best suited for a specified purpose and location. Because of the great diversity in types and the conflicting opinions as to their relative merits, the reader may well be puzzled in his choice of what is best for his particular needs.

The antenna is a most important factor in determining the performance of a radio transmitter or receiver. The type should be selected on the basis of known facts and not guesswork. Yet space limitations may require that a highly-directive antenna be erected on top of a small dwelling, or that it be operated at a wavelength higher than its fundamental. The text tells how these, and many other problems, can be solved at a minimum of effort and expense.

Having decided upon the type which will produce the greatest gain, and thus the most economical operation of a transmitter or the most effective results from a receiver, the experimenter then needs information as to how it should be built. He is interested, not only in theory but also in good practice; not in elaborate discussions of complex systems, but in simple directions for their design and construction. He may find them here, as determined from the experience of the author and other successful radio operators.

This modest little volume is written to serve those who want to put out a better signal from their transmitter or bring cleaner signals into their receivers.

November 1, 1936

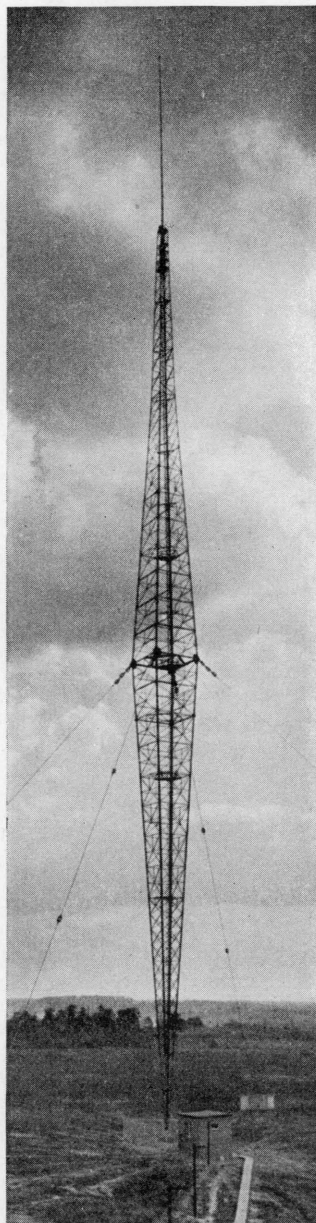

Copyright, 1936

By

Frank C. Jones

ANTENNAS

Antenna Theory

● An antenna is an electrical conductor, suspended in air and insulated from ground, which either radiates or receives radio-frequency energy. Sometimes the ground is used in conjunction with the antenna conductors, as will be defined later. The effectiveness of an antenna depends upon numerous electrical and mechanical factors of design, all of which are discussed under *antenna types*.

An antenna can be compared to any tuned circuit, except that its capacity and inductance are distributed along the wire instead of being lumped, as in a coil and variable condenser. Every antenna system has a fundamental wavelength or resonant frequency of its own. It should always be operated at its resonant frequency, because the efficiency is many times greater in this condition.

The physical dimensions of the antenna at resonance bear a certain relation to the wavelength. In order to simplify the explanation of *radiation* in space, it can be compared with waves in water produced by throwing a stone into a still body of water; there will be waves which have peaks and troughs, similar to those produced in space by radio waves. The radio waves, in effect, require a physical amount of space between the peaks and troughs (*condensations and rarefactions*) and therefore the antenna is made of such a length that it is equal to one peak or one trough of a wave in physical length.

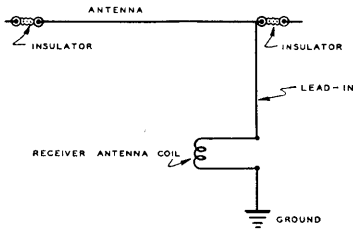

FIG. 1

Conventional Antenna for Receiving.

A complete wave consists of one peak and one trough, defined as *one wavelength*. Any resonant circuit is the electrical equivalent of one-half wavelength; in the case of a tuned circuit the constants are lumped and

the space required is very small. For an antenna, the wire may be stretched out into a straight line so that it is nearly a full half wavelength long. For an antenna consisting of a straight wire one-half wavelength long electrically, the *physical* length will be approximately 5% shorter than the *electrical* length, because it is impossible to secure a wire having zero diameter supported in space without end insulators.

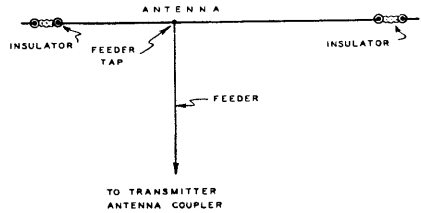

FIG. 2

Single Wire Antenna for Transmitting.

Radio waves travel with approximately the speed of light, which is 300 million meters per second. This provides a convenient method for expressing the resonant frequency in terms of wavelength, or vice-versa.

$$F = \frac{300,000,000}{\lambda}$$

where F is the frequency in cycles per second and λ is the wavelength in meters.

Radiation Field

● A wire connected to any source of oscillating electrical energy will radiate radio waves due to the varying intensity of the electrical field surrounding the wire. The field closest to the wire is called the *induction field*, which oscillates to-and-fro; that part of the field which escapes forms the energy in the radiated field which is urged outward and diffused in all directions through space. Any wire supported in space and within range of the radiated field will intercept the energy and will have induced in it a radio-frequency voltage, which is detectable as an incoming signal by receiving apparatus.

Radio waves are transmitted from an antenna through space in two general types of waves. One is called the *ground wave*,

which follows along the surface of the ground, and is rapidly attenuated for very short waves. The ground wave is useful in long-wave radio communication, also for very short distance work on ultra-short wavelengths. Best broadcast reception is always had when the receiver picks up only the ground wave, which means that normally it must be within a 100 mile radius of even a high power transmitter. *Fading effects* take place at greater distances, due to the interference between the ground wave and the sky waves.

That portion radiated upward from the antenna is known as the *sky wave*, since it is reflected back to earth by ionized layers in the upper atmosphere known as *The Kennelly-Heaviside Layers*, as shown in Fig. 3.

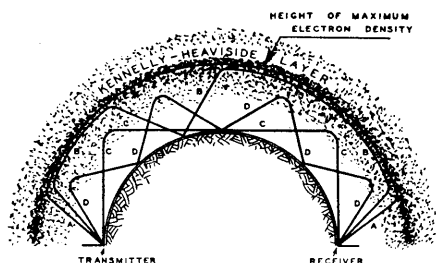

Fig. 3

Reflection of Radio Waves from the Heaviside Layer Around the Earth.

At very low angles of radiation, the waves start out practically tangent to the earth's surface, penetrate into the ionized layers and are bent back to the earth at a very distant point. Higher angles of radiation are bent back to earth at shorter distances until a certain high angle is reached for any particular frequency which will not be bent back to earth. This angle varies with the season of the year, frequency and time of day. At angles slightly less than this value at which the layers are penetrated, the radio waves can be carried around one of the upper layers to extremely great distances before being bent back to earth, no matter what the angle of propagation.

The Kennelly-Heaviside Layer is a strata of ionized air molecules, of which the ionization is due to the ultra-violet radiations from the sun. This stratospheric layer lies above the earth at distances of less than one hundred up to several hundred miles elevation. The relative density of the layers is not constant, but varies from year to year and seems to depend upon sun-spot activity.

The time required for the sky waves to reach the receiver varies in accordance with the number of reflections to and from earth and the changes of ionization in the Ken-

nelly-Heaviside Layers. Obviously the time required for a ground wave to reach the receiver will be less than that of a high angle sky wave, resulting in variations of signal strength at the receiver. When two or more waves from these different paths arrive at the same instant (*in phase*) the signal strength will be greatest. If the time lag is great enough so that one wave tends to neutralize another (*out of phase*), the signal intensity will decrease, resulting in the phenomena known as *fading*.

The rate of fading varies with frequency, and even small changes of frequency sometimes have entirely different rates of fading. A modulated wave from a radiophone station consists of a band of frequencies being transmitted, and this variation of fading within this narrow band results in distortion in the received signal. This effect is known as *selective fading*, because the side-band frequencies may be stronger at a given instant than the carrier signal at the receiving point, resulting in bad distortion of audio quality in the output of the receiver.

Electrical Properties

- A wire stretched out into space has *inductance* of the same type as that produced by wire wound into a coil. This antenna wire also has a *distributed capacity* to nearby objects, such as the ground. As in any electrical circuit, inductive reactance and capacitive reactance impede the flow of current in either a transmitting or receiving antenna. At resonance, the inductive reactance is equal and opposite to the capacitive reactance, with the result that the electrical current is only limited by the resistance. The resistance consists of several components, such as wire resistance, dielectric losses from nearby objects, ground resistance, insulator losses and *radiation resistance*. The latter is a fictitious term which is useful in expressing the power radiated by the antenna. It is that resistance which would consume the same amount of power that is radiated into space by the antenna; the power lost in other forms of resistance is wasted. Short-wave antennas generally have a very high ratio of radiation resistance to loss resistance and are therefore very efficient.

In a resonant antenna, *standing waves* of current and voltage exist. In a typical half wave antenna the current is maximum at the center, and zero at the ends. The radio-frequency voltage is maximum at the ends and minimum at the center. These standing waves exist because an impressed radio wave will travel out to the end of the antenna and be reflected back toward the center, since the end is an open circuit corresponding to a large mismatch of im-

pedance. The resonant antenna is of such length that the reflected wave will be in phase with each succeeding impressed wave, or oscillation, resulting in a standing wave along the antenna wire. Standing waves produce more actual radiated power into space from an antenna than when the values of voltage and current are uniform and of lower value all along the antenna wire. Radio-frequency feeders to an antenna are generally designed for uniform distribution of current and voltage along their entire length (no standing wave). In other words, the feeders should *not* radiate because the antenna proper alone should be the radiating medium.

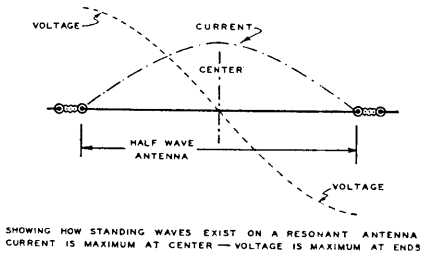

FIG. 4

The *impedance* along a half wave antenna varies from a minimum at the center to a maximum at the ends. The impedance is that property which determines the antenna current at any point along the wire for the value of radio-frequency voltage at that point. The main component of this impedance is the radiation resistance; normally the latter is referred to the center of the half wave antenna where the current is a maximum. The square of the current multiplied by the radiation resistance is equal to the power radiated by the antenna, and for convenience these values are usually referred to the center of a half wave section of antenna.

The curve in Fig. 5 indicates the theoretical center point radiation resistance of a half wave horizontal antenna for various heights above ground. These values are of some importance in matching radio frequency feeders to the antenna in order to obtain both a good impedance match and an absence of standing waves on the feeders.

A transmitting antenna usually consists of a wire of definite length which may be grounded, ungrounded or connected to a counterpoise. A ground made by either a direct or capacitive connection acts as a reflector to the aerial wire, therefore completing the circuit. With a direct ground connection, the antenna may be either an electrical quarter wavelength or odd multiples of quarter wavelengths; the ground

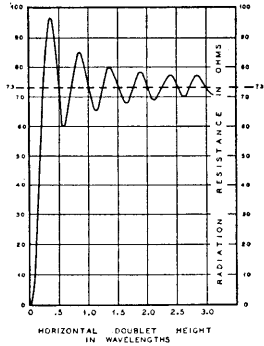

Fig. 5

Radiation Resistance of Half Wave Horizontal Antenna for Various Heights Above Ground.

acts as a subterranean reflector, furnishing quarter waves to the antenna to give half waves or multiples of half waves for the desired resonant effect. A very short wire can be loaded to an electrical quarter wave by means of a loading coil to ground; a wire over a quarter wave long can be reduced to an electrical quarter wave by means of a series condenser to ground.

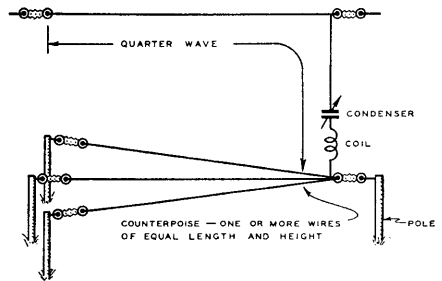

Fig. 6

A counterpoise which consists of one or more wires in a network insulated from ground will often reduce loss resistances which might occur when the quarter wave antenna is connected to poorly conducting earth. The counterpoise in the case of a network of several wires acts as a condenser plate with high capacity to earth, with the result of lower loss in the antenna system; for this reason the counterpoise should be fairly close to the ground.

Fig. 7 shows a vertical antenna with an elaborate ground wire system buried under the surface of the earth for the purpose of obtaining low loss resistance connection to ground. This system is more generally used than the counterpoise.

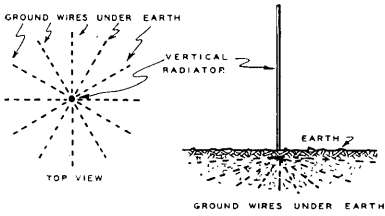

Fig. 7

Directional Properties

● The radiation field of an antenna is more intense in certain directions, depending upon its height above ground, as well as the length of the antenna and the tilt or angle of the antenna wire with respect to ground. A short antenna (up to a half wavelength long) radiates most of its energy in a circular pattern at right-angles to the wire, something in the shape of a doughnut.

As the length of a horizontal antenna is increased in multiples of half waves, the radiation pattern changes into cone-shaped loops, one at each end of the antenna. Smaller intermediate loops occur as shown in Fig. 8. A short horizontal antenna, therefore, may be considered as a *broadside radiator* and a long antenna as an *end-fire radiator*. A vertical half wave or quarter wave antenna radiates equally well in all directions, horizontally.

Angle Radiation

● All but the ultra-short-waves are reflected back to earth from the Heaviside Layer. By directing the greater portion of the transmitted wave at certain angles above the horizon, the signal at the receiving station will be increased; the angle above the horizon depends upon the distance and condition of the Heaviside Layer. For extremely long distances a low angle radiation is preferable, or an extremely high critical angle above the earth horizon. Intermediate angles tend to shorten the skip distance, and in case of long distances the total number of reflections may be so great as to attenuate the signal to such an extent that it cannot be received. Each time the signal is reflected from the earth's surface back to the Heaviside Layer the signal strength is reduced, due to losses which become evident because the earth is not a perfect reflector.

Vertical antennas provide low angle radiation as indicated in Fig. 9. The earth acts as a mirror and prevents the radiated wave from going out exactly in a plane to the horizon, unless the vertical antenna is several wave lengths above the earth.

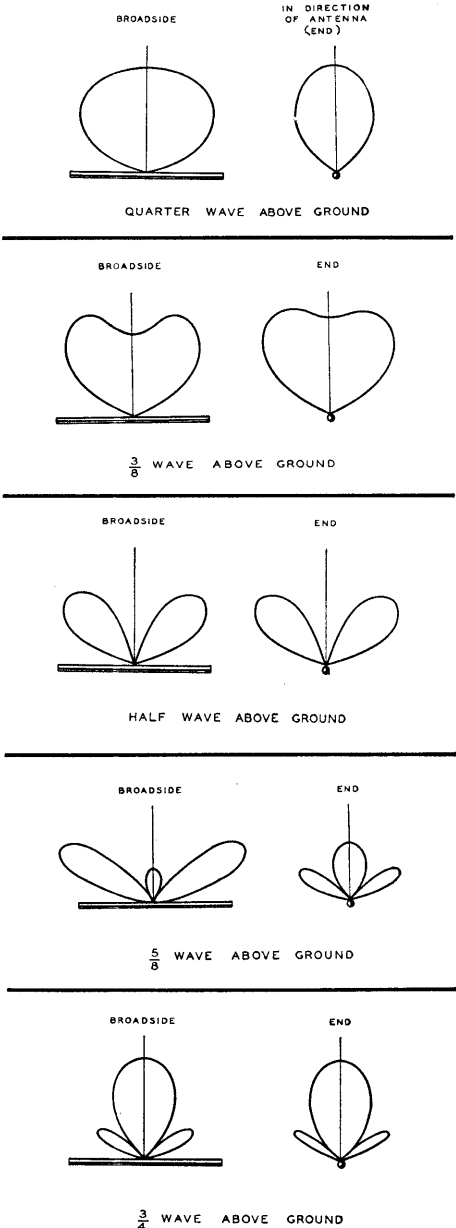

Fig. 8

Horizontal Half Wave Antenna Radiation Patterns.

The effect of the earth on the angle of radiation is more noticeable in the case of horizontal antennas, as can be seen in Fig. 10, showing that the horizontal antenna

should be approximately a half wave above ground in order to avoid excessive radiation straight up, which would penetrate the Heaviside Layer and not be reflected back to earth at distant points.

Heights above ground of one quarter wave and three quarter waves provide excessive radiation straight upward, which represents a loss of power. The radiation pattern shown in C of Fig. 10 indicates that nearly all of the radiation is at right angles to the antenna wire. This is not actually true, because the doughnut-shaped radiated field actually produces high angle radiation outwardly over the ends of even a half wave horizontal antenna.

Long antennas operated at a harmonic tend to give low angle radiation. An analogy can be made to an ordinary garden hose and nozzle when considering the radiation from one end of the antenna. As the nozzle is turned from the fine spray position, the cone of water has a more narrow angle and is more concentrated. A second or third harmonic antenna (two or three half waves) is like the fine spray condition, whereas a long antenna of six or eight wavelengths projects most of the signals outward in the form of a very narrow cone, having a radiation much greater at its maximum as compared with a half wave antenna.

Careful antenna design will enable a low power transmitter to deliver a powerful signal at certain distant points.

Antenna Tilt

● The presence of ground near any horizontal antenna has a very decided effect upon its directivity pattern. A half wave antenna normally produces high angle radiation from its ends, and both high and low angle radiation from its sides, as can be seen by referring back to Fig. 8.

The difference becomes more pronounced with a full wave antenna; in either case, tilting the antenna will lower the angle of radiation to some extent in line with the antenna wire. Since low angle radiation is generally desirable for long distance communication, a slight tilt from the horizontal angle with respect to earth in the desired direction will often produce a very noticeable increase in signal strength. An antenna which has one end higher above the earth than the other does not transmit or receive well in the direction toward the higher end.

Antennas for Transmitting

● Antennas for transmitting differ from those used for receiving only in that the former require better insulation. A good

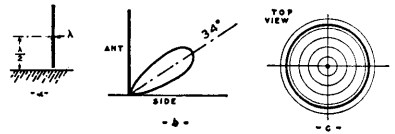

Full Wave Antenna Gives Maximum Radiation Upward at an Angle of 34 Degrees from the Horizon.

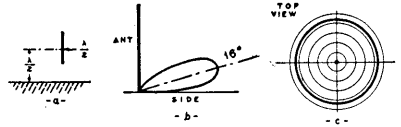

Half Wave Antenna, Same Height as Full Wave Antenna Above. Here the Radiation Is Known as 16-Degree "Low Angle" Radiation.

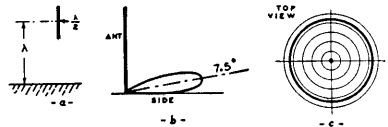

Increasing Height of Antenna Above Ground Lowers Angle of Radiation to 7.5 Degrees, as Shown.

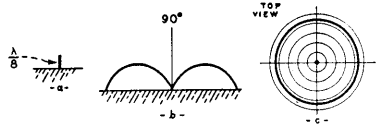

Short Vertical Antenna, Grounded, Gives Very Low Angle Radiation.

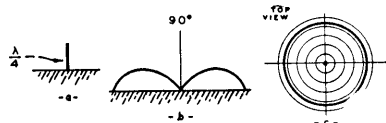

Quarter Wave Grounded Antenna Concentrates More of the Radiation at a Low Angle Than the 1/8 Wave Antenna Does.

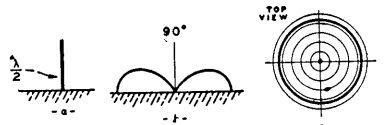

Grounded Half Wave Antenna.

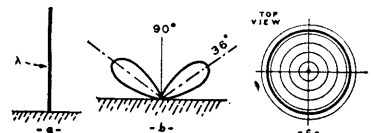

Full Wave Grounded Antenna.

**Fig. 9
Angle of Radiation of Half Wave Vertical Antennas.**

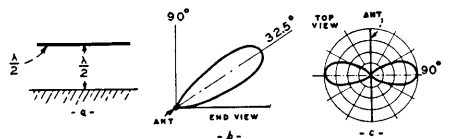

Horizontal Antenna Half Wave Above Ground. This is the best height for horizontal antenna for general use.

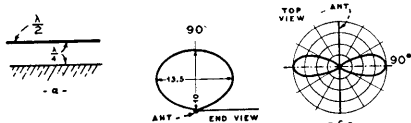

Horizontal Antenna, Quarter Wave Above Ground.

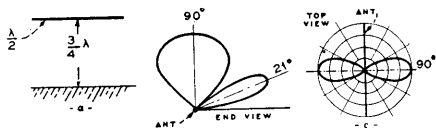

Horizontal Antenna, $\frac{3}{4}$ Wave High, Radiates Mainly Upward.

Fig. 10

Showing How the Earth Affects the Angle of Radiation from a Horizontal Antenna.

antenna for transmitting likewise makes a good antenna for receiving. All antennas for transmitting fall into two general classifications: (1) A half wave, or multiple of half waves, known as a *Hertz Antenna*, (2) A quarter wave, or odd multiples of quarter waves, known as a *Marconi Antenna*, because it must be used in conjunction with either a ground or counterpoise connection. For frequencies above 3,000 KC (100 meters), Hertz Antennas are more efficient because losses caused by ground connections are eliminated. The *Hertz* designation covers such types as *Single Wire Fed*, *Zepp*, *Two Wire Fed*, *End Fed*, *Doublets*, and *Directional Arrays*, because these systems use half wave sections of antennas for the radiating portion.

Marconi Antennas are generally used for frequencies below 3000 KC because space requirements are less than when Hertz Antennas are used. Marconi Antennas are generally a quarter wave long, measured between ground and the far end of the antenna. The electrical length can be adjusted by a tuning condenser, either in shunt or in series with the coupling coil. A shunt condenser increases, and a series condenser decreases, the electrical length of the antenna system. The Marconi Antenna is cut so that the electrical length is exactly a quarter wave long; the coupling coil and tuning condensers can be eliminated and some form

of single wire feed line can be used to supply power from the transmitter to the antenna. The effectiveness of a Marconi Antenna depends on its height above ground, also upon a very low resistance ground connection. Where a sufficiently low resistance ground is not available, a counterpoise is used. If the physical length does not exceed a quarter wave by more than $\frac{1}{3}$ rd, the use of a series tuning condenser will reduce it to an electrical quarter wavelength. For wires less than a quarter wave long, an inductance (loading coil) will lengthen the antenna to a quarter wave electrically. The effective electrical length of the antenna can be increased slightly by the use of a large capacity at the end of the wire, such as insulator caps, balls, or cages.

Choice of Antenna

● There are so many suitable types of antennas for accomplishing a similar result that a brief explanation of some of the features of each is here disclosed. For 160 meter operation, some form of Marconi Antenna is desirable because most Amateurs have only a limited amount of space in which to erect an antenna. Most Marconi Antennas radiate a fairly strong ground wave, which is desirable for short and moderate distance communication. For 80 meter operation, the choice lies in some form of half wave antenna, such as a Zepp, End Fed, or Single Wire Fed. The difference lies in the method of coupling the radiating portion of the antenna to the final amplifier of the transmitter. Any one of the three aforementioned antennas can be operated on several bands by utilizing harmonics of the antenna. For example, a 130 foot half wave antenna operating on 80 meters becomes a full wave second harmonic antenna on 40 meters, and a two wave fourth harmonic antenna on 20 meters. Other forms of 80 meter half wave antennas are often desirable under certain conditions.

The Johnson "Q," Collins All-Wave Antenna, Two Wire Matched Impedance Antenna, and the Twisted Pair Feeder Antenna are all suitable for 80 meter operation. The advantages and disadvantages of each are discussed elsewhere in these pages.

Figure 11 shows the directivity patterns of a horizontal antenna operated at its fundamental and on its various harmonics.

For 40 meter operation, any of the types listed for 80 meter operation are suitable, yet an antenna for 80 meter operation is twice as long as one required for 40 meter operation. Directional effects should be taken into consideration if space permits the choice of antenna placement. For 20 meter operation, the same types of antennas are suitable, but on this band the physical size of the antenna is so small that highly-direc-

Antenna Theory

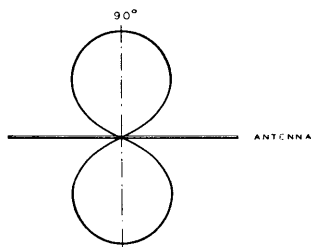

HALF WAVE ANTENNA
(1ST HARMONIC OR FUNDAMENTAL)

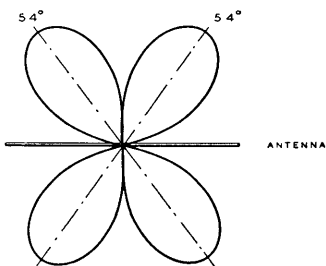

FULL WAVE ANTENNA
(2ND HARMONIC)

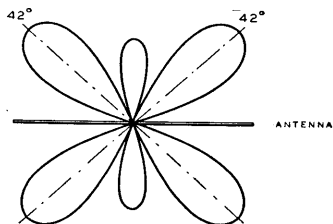

$1\frac{1}{2}$ WAVE ANTENNA
(3RD HARMONIC)

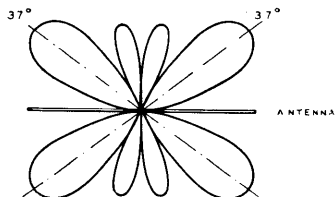

2 WAVE ANTENNA
(4TH HARMONIC)

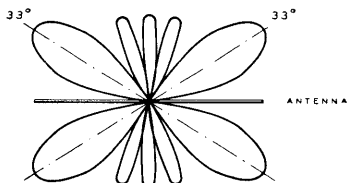

$2\frac{1}{2}$ WAVE ANTENNA
(5TH HARMONIC)

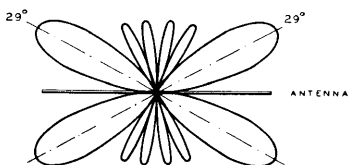

3 WAVE ANTENNA
(6TH HARMONIC)

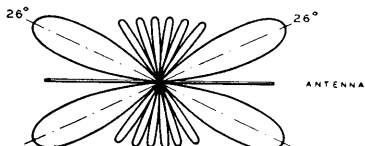

4 WAVE ANTENNA
(8TH HARMONIC)

Fig. 11
Radiation Patterns of Horizontal Antennas,
Half Wave to 4 Waves Long.

tional types can be used to greater advantage. Directional antennas increase the power radiated in some certain desired directions, but at the expense of lower radiation in the other directions.

For 10 meter operation any harmonic antenna can be used, although a half wave vertical antenna is most popular because it transmits a very low angle of radiation and is non-directional. Directional arrays are easily constructed for operation on this band, and they are equivalent to greatly increasing the power in the transmitter proper.

The ground wave alone is useful for 5 and $2\frac{1}{2}$ meter operation, and thus the vertical types of antennas are more suitable. For short distance communication (a few miles), a single vertical half wave antenna, mounted as high as possible, gives satisfactory results. Directional arrays are recommended for point-to-point communication. Various forms of directional arrays should be used for micro-wave operation because these arrays can be easily rotated, due to their small physical size. Half wave or quarter wave antennas are only occasionally used for micro-wave communication.

Single Wire Fed Antenna

● When a single wire feeder is connected to the proper impedance matching point of a half wave (or multiple of half waves) in the radiating portion of an antenna, it is called a *Single Wire Fed Hertz Antenna*. The center impedance is somewhere between 50 and 100 ohms in a half wave antenna, increasing outwardly toward the ends. A feeder wire can be attached at a point of about 500 to 600 ohms impedance either side of center for the purpose of supplying RF energy from the transmitter. In this case, the ground acts as a phantom return circuit and the characteristic impedance of the single wire to ground is in the neighborhood of 600 ohms. The exact value of impedance varies with the frequency of operation and the diameter of the conductor.

Antenna Impedance

● The impedance of any circuit is a function of the reactance and resistance which impedes the flow of current. In a resonant antenna the reactive terms cancel each other, as in any resonant circuit, and the impedance is equal to the resistance which in this case is largely radiation resistance. The radiation resistance at the center of a half wave antenna is about 73 ohms, and 2400 ohms at the ends if it is very high above earth. It can thus be seen that at either side of center, values of from approximately 73 ohms to 2400 ohms can be obtained for impedance matching to non-resonant RF feeders. The single wire feeder is one type of non-resonant line.

A non-resonant RF feeder system of infinite length has a characteristic surge impedance which is a function of the diameter of the wires, the spacing and the dielectric between the wires. Short lines, such as used in radio practice, can be terminated by using the characteristic impedance as a load, which makes the line equivalent to one of infinite length without reflections and standing waves of RF voltage. If the line is not terminated by the proper impedance the impressed radio wave will be reflected and standing waves will exist to cause radiation from the feeder or feeders. To simplify the foregoing explanation, the single wire feeder gives best results when it is connected across approximate 600 ohms of antenna impedance. This value of impedance (600 ohms) normally occurs at a point about one-seventh of the total length either side of center. The same applies to any half wave antenna which is not too close to nearby objects or ground. Under conditions of perfect impedance match there will be no standing waves on the RF feeder and maximum efficiency will result. Unfortunately,

this point is not correct for harmonic operation and if the single wire fed antenna is to be used on several bands a compromise should be made which will not materially lower the efficiency on any band. The feeder should be connected to the antenna at a point one-sixth, instead of one-seventh, of the total length of the antenna either side of center. Another simple way to find this point is to divide the antenna into three equal lengths and attach the feeder at a point one-third of the total length from either end. See Fig. 12.

Typical example: A 134 foot 80 meter antenna (for operation on 80, 40, 20 and 10 meters) should be tapped 45 feet from one end, or 22 feet from the center of the antenna. See Fig. 12. This automatically places the tap 12 feet from center of one of the half wave sections when the antenna is operated on 40 meters, and 5 feet from the center of a half wave section when the antenna is operated on 20 meters. These values are such that good impedance match will be had, resulting in satisfactory all-band operation. For a 67 foot (40 meter) antenna, the tap should be a little over 22 feet from one end, which places it at about 11 feet from center. This automatically provides a point which is 6 feet off-center on 20 meters and 2½ feet off-center on 10 meters. The value of 9-feet-4-inches-off-center for a 40 meter antenna, widely recommended in the past, gives a distance of only 0.8-foot off-center for 10 meter operation, which explains why such poor results are obtained when such a 40 meter antenna is used for 10 meter operation. The same holds true for 80 meter antennas operating on 20 meters. Connection of the feeder at a point of such low impedance for harmonic operation will not provide much actual radiation from the flat top portion of the antenna.

There will be a small standing wave on the single wire feeder when it is terminated one-third the distance from the end of the antenna. The reactive effect can be practically eliminated by making the feeder some multiple of quarter waves long. At the station end, the impedance would then be purely resistive, and no detuning effect will be in evidence in the final amplifier tuning circuit when connecting or disconnecting the feeder. The formula for calculating the feeder length in feet is:

$$l = \frac{234,000}{f_1}$$

Where f_1 is the lowest frequency of operation in Kilocycles, l is the feeder length in feet.

Single Wire Fed Antenna

SINGLE WIRE FED ANTENNA FOR ALL BAND OPERATION

ANTENNA FOR 80, 40, 20 & 10 METERS IS 134 FEET LONG, WITH SINGLE WIRE FEEDER TAPPED 22 FT. OFF CENTER. THE FEEDER CAN BE EITHER 66 OR 132 FEET LONG.

ANTENNA FOR 40, 20 & 10 METERS IS 67 FT. LONG, WITH FEEDER TAPPED 11 FT. OFF CENTER. THE FEEDER CAN BE 33, 66 OR 99 FEET LONG.

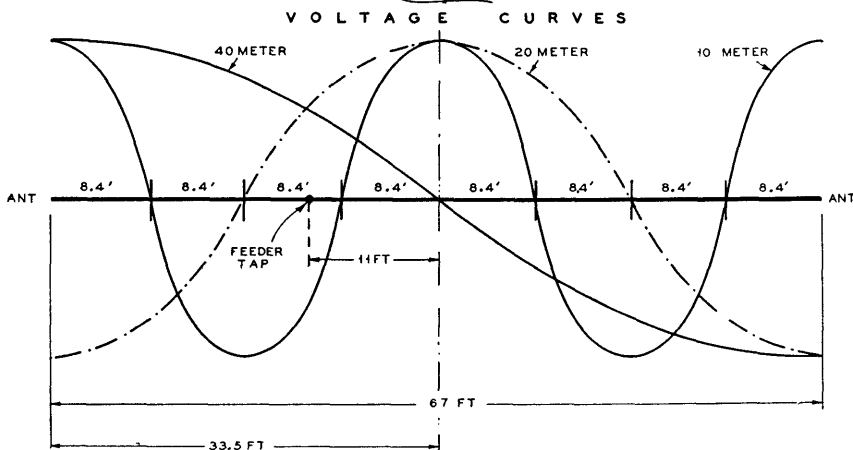

Fig. 12

The antenna length should be cut so that it will resonate at the middle frequency band desired. The formula:

$$L = \frac{(K - .05) 492,000}{f_2}$$

where L is the antenna length in feet,
 f_2 is the frequency in kilocycles,
 k is the number of half wavelengths
 at that frequency.

The slight error in length for the lower and higher frequencies must be tolerated because the actual length is a compromise. The end effects shorten a half wave antenna approximately 5%, which is equivalent to 2½% per end. In a long antenna, such as two full waves, the two end half wave sections are each shortened 2½%. The middle sections are not shortened. This means that a wire cut for 3,600 KC operation as a half wave antenna will be a little short for operation as a full wave antenna on 7200 KC, which is the second harmonic. In spite of these minor defects, this antenna has become highly popular and is being widely used because of its simplicity and all-around usefulness.

Non-resonant feeders of any type can be of any length and sometimes they are made as long as 4000 feet. No sharp bends should be tolerated, otherwise the RF wave will be reflected and standing wave effects will result. *The feeder wire should run at a right-angle to the flat top portion for at least a quarter wavelength from the point where*

it attaches to the antenna. A single wire feeder should always be used in conjunction with a good ground connection at any wavelength because the single wire feeder uses the ground as part of its return system in feeding power to the antenna.

One of the disadvantages of the single wire fed antenna is a tendency for the RF to feed back into electric wiring circuits near the transmitter. In radiophone operation this feedback can find its way into the microphone circuits, resulting in distortion and audio howls.

Coupling the Single-Wire Feeder to the Final Amplifier

● A single-wire antenna with off-center feeder should preferably be coupled to the final amplifier by means of system A, shown in Fig. 13. B and C are alternate methods for increasing or decreasing the electrical length of the feeder, yet these methods are seldom required.

The method shown in A consists of link coupling the final amplifier plate coil to an antenna tuning system. L1 is the final amplifier plate coil. L2 is a coupling loop of from one to four turns of insulated wire around the center of L1. L3 is a similar coupling loop around the center of the antenna coil L4.

L4 should have approximately 10% fewer turns than L1, but both coils should be of the same diameter. The coupling loops L2 and L3 are connected together with a twisted pair feed line so as to isolate the

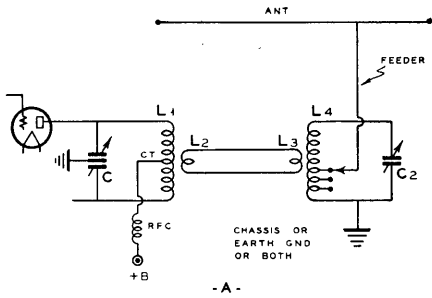

- A -

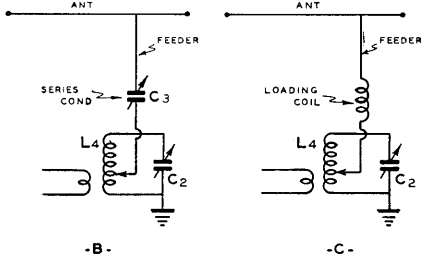

- B -

- C -

Fig. 13

"A" Is the Best Coupling System for a Single Wire Feeder; "B" and "C" Are Seldom Used in Amateur Practice.

final amplifier plate coil from the antenna coil by several feet. L4 is tuned with a 100 mmfd. variable condenser which has sufficient plate spacing to prevent flash-over. Taps are soldered to L4 at points beginning approximately one-third the way up from the grounded end of the coil, and continuing up the coil to a point near the center. One end of L4 should be grounded to the transmitter chassis, or to an earth ground, or both.

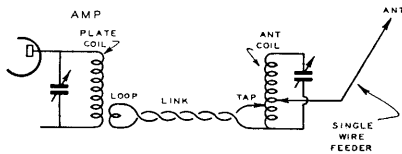

Fig. 14

Alternate Method of Coupling Single Wire Antenna by Tapping the Link Line Directly to the Antenna Coil. The Lower End of the Antenna Coil Should be Grounded, Unless the Antenna Is of the End-Fed Type.

A small flashlight globe, or a 0-to-1 RF antenna ammeter should be connected in series with the feeder and the tap on coil L4 in order to provide a means of comparative indication of antenna power. See Fig. 15. The indicating device should be removed, or short-circuited, at the completion of the tests.

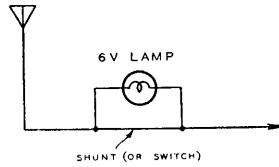

Fig. 15

Lamp Indicator or R-F Meter for Denoting Comparative Output.

Tuning Procedure

(1) With the antenna feeder *disconnected* from coil L4, tune the final amplifier plate circuit to resonance, then tune the antenna coil to resonance. The final amplifier plate current should take the customary pronounced resonance dip when *either* the plate or antenna circuit is tuned to resonance. If resonance in the final amplifier cannot be secured when the antenna coil is tuned, turns should be removed from, or added to, coil L4. When resonance is secured by tuning *either* circuit, the antenna feeder should be connected to L4.

(2) Connect the feeder to a tap on L4 at a point about one-third the way up from the grounded end of the coil. Observe the indication of the RF antenna meter or flashlight globe. Hold one hand on the final plate tuning condenser dial, the other hand on the antenna tuning condenser dial. Vary both condensers at the same time and tune for maximum indication of the RF meter or flashlight globe. Then connect the antenna feeder to a different tap on coil L4 and repeat the tuning process. A tap position will soon be found which gives greatest indication of antenna power, at normal plate current. Once the system is correctly tuned, the resonance dip indicated by the final amplifier plate milliammeter will be very small when the final plate condenser is tuned through the resonance point. If the dip is pronounced, make slight readjustments of both circuits until maximum indication is shown by the RF meter or flashlight globe. The point to remember is that both condensers should be tuned and retuned simultaneously for maximum output.

(3) If the final amplifier draws more than normal plate current after the system is tuned to resonance, remove a turn or more of wire from both L2 and L3; conversely, add a turn or more to both L2 and L3 if the plate current is too low.

Relative Radiation Patterns

● Fig. 16 shows other methods for coupling the single wire feeder here described, as well as a sketch showing the directivity of an 80 meter antenna of this type. For all-around

Single Wire Fed Antenna Tuning

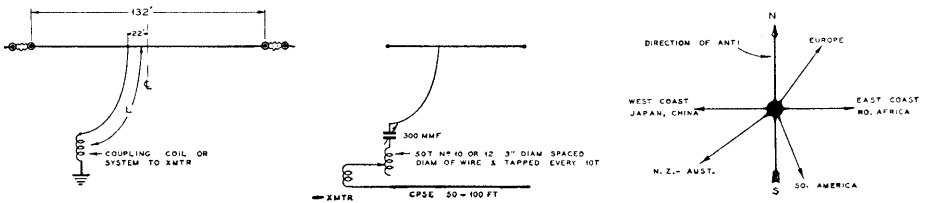

FIG. 16.

Left: 80-Meter Antenna, 132 to 134 Feet Long, Suitable for Operation on 80, 40, 20 and 10 Meters. Center: Antenna Feeder Loading System for 160 Meter Operation. Right: Approximate Direction of Other Countries.

operation in as many directions as possible, from any point in the United States, this 80 meter antenna should preferably be run in a North and South direction, as shown. On the other hand, when this same antenna is operated on its harmonics, the antenna directivity changes to four main lobes in the approximate directions as shown.

the figures. The radiation is in the form of a doughnut for a half wave antenna and consequently high angle radiation *does* take place in the end directions, assuming that the antenna points North and South. The main low angle radiation on 80 meters would be East and West. When this 80 meter antenna operates on harmonics, the radiation

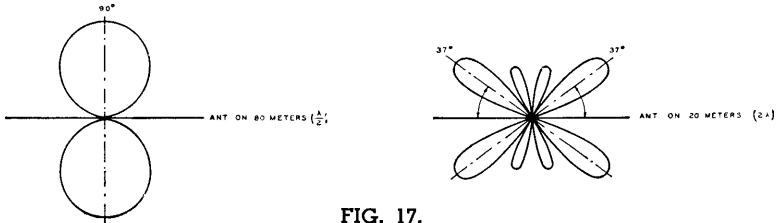

FIG. 17.

80- and 20-Meter Radiation Patterns for All-Band Single-Wire Fed Antenna.

All of the lobes in Figs. 17 and 18 apply to an 80 meter antenna, operating on harmonics. Long-distance operation is more easily accomplished on the shorter wavelengths, such as 10, 20 and 40 meters, thus making it a very effective all-band radiator. The directivity patterns do not hold good for *all* locations, and neither is it necessary to point the antenna in the prescribed direction in order to communicate with other countries or localities. However, if an approximate North and South placement can be arranged, better results will be secured.

appears to be in four separate directions, or lobes, as shown in Fig. 18. The radiation goes out in two main cones and therefore it is not as directional as would appear at a casual glance.

Impedance Matching Stubs

● In a great many directive antenna arrays, and often in the more simple forms of antennas, an impedance matching "stub" is desirable. This stub permits the use of a non-resonant feeder system, which results

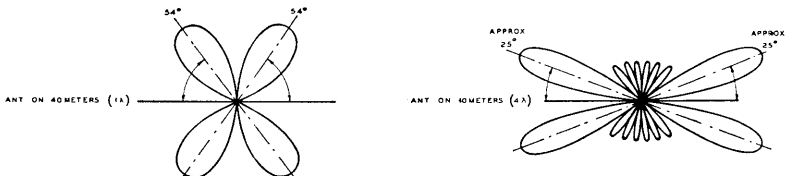

FIG 18.

40- and 10-Meter Radiation Patterns for Same Antenna.

Fig. 18 shows the radiation patterns of an 80 meter antenna of this type when operated on 40 and 10 meters. These diagrams show the cross-section only, therefore the directivity, in effect, is not the same as indicated in

in better efficiency than could otherwise be obtained with long Zepp feeders. The *stub* consists of a quarter or half wave section of feeder, either open at the lower end, or with a sliding link for tuning the stub. Fig.

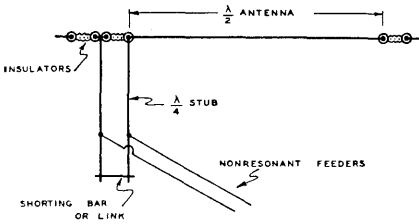

Fig. 19
Half Wave Antenna with Quarter Wave Matching Stub.

19 shows a quarter wave stub, which is similar to a quarter wave Zepp feeder.

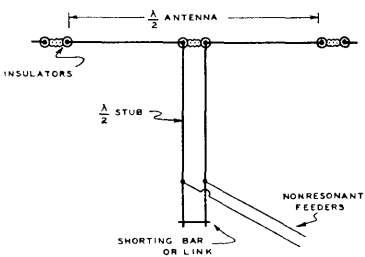

Fig. 20
Center Fed Half Wave Antenna with Half Wave Matching Stub.

Fig. 20 shows a half wave stub for feeding into the center of a half wave antenna.

The impedance at the short-circuited end of this stub is only a few ohms, and this impedance increases toward the antenna end. A non-resonant feeder can be tapped across this stub at a point corresponding to its characteristic impedance, which usually lies between 400 and 600 ohms.

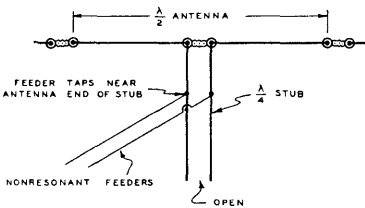

Fig. 21
Center Fed Half Wave Antenna with Stub Line Cut to Exact Length Without Shorting Bar.

The antenna length and stub length must be such that exact resonance is obtained. In the case where the stub has a shorting link near one end, the link may be moved up or

down to tune the system to resonance with the transmitter frequency. In the case of a center fed antenna with a quarter wave stub without shorting link, Fig. 21, the wires must be cut to correct length by trial in order to obtain resonance. The non-resonant feeders tap across the matching stub at a point which eliminates standing waves on this line. The antenna and stub lengths should be correct for the particular installation in order to eliminate standing waves on the non-resonant feeders. The crystal detector-milliammeter measuring device described in Fig. 95 is suitable for tuning up this type of antenna system.

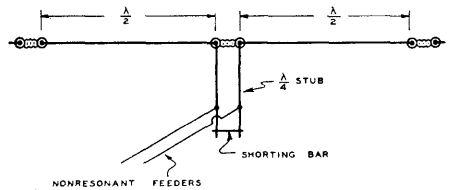

Fig. 22
Two Half Wave Sections in Phase, with Quarter Wave Stub.

In Fig. 22 two half wave sections are used in phase in order to obtain greater radiation at right angles to the direction of the antenna.

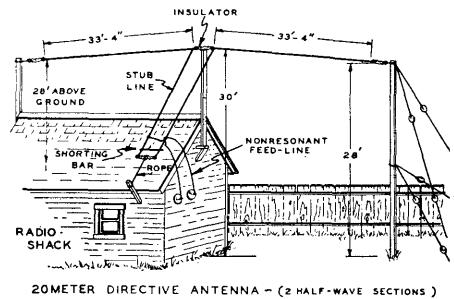

Fig. 23
Pictorial of Fig. 22, Showing Simplicity of 20 Meter Antenna Installation.

In one particular installation (Fig. 23) it was found that the standing waves on the non-resonant feed line could not be eliminated until one of the half wave antennas was shortened nearly 10%. The apparent reason was the proximity of a small metal chimney to one end of this antenna.

Impedance Matching Stubs

10 Meter Vertical Antenna With Matching Stub

● A very effective antenna system for non-directional 10 meter operation is shown in Fig. 24. It consists of a 25 foot pole, supported on the roof or to one side of a building or other structure, a 16½ foot vertical antenna wire run up along the pole and insulated from it with small insulating strips or rods. At the bottom of the 16½ foot section is another section of two wires, called the matching stub. These wires are 8 feet long, one of them being a portion of the antenna proper. A shorting bar, connected across the bottom of the two wires, is moved upward or downward for antenna tuning; likewise, the feed line tapped across the two wires at a point about ⅓rd the way down from where the two wire portion begins, is also later adjusted and readjusted in tuning up the system.

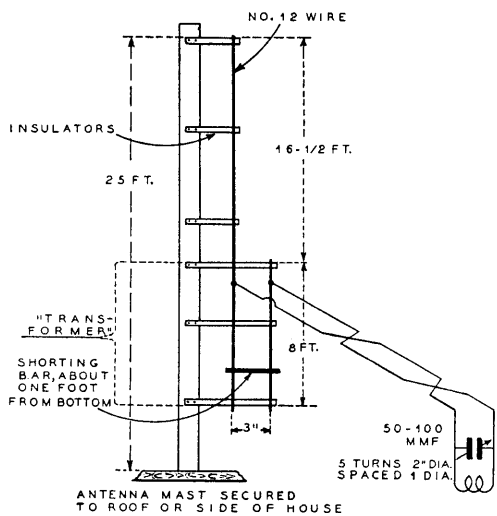

10-METER VERTICAL ANTENNA WITH QUARTER WAVE MATCHING TRANS.

Fig. 24

Tuning Procedure

- (1) Place transmission line ⅓rd the way down from the point where the two wires begin, that is, ⅓rd the way down from the top of the "matching transformer."
- (2) Adjust the shorting bar by placing it approximately 1 foot or 18 inches from the bottom of the "matching transformer."
- (3) Turn "on" transmitter, and loosely couple the antenna coil to the final amplifier plate coil.

- (4) Place a "field strength meter" (described in Fig. 91) somewhere where it can be seen from the roof, or let someone else watch the reading of the meter.
- (5) Never re-adjust the field strength meter once it is set, while the antenna is being tuned.
- (6) Take readings on the field strength meter and adjust the antenna coupling to the instrument so that half scale readings are obtained.
- (7) Return to the roof, put on a pair of gloves, and adjust the shorting-bar until the field strength meter denotes maximum reading.
- (8) Next, adjust the position of the feed-line to a point, where maximum indication is again had on the field strength meter.
- (9) Lastly, re-adjust the shorting-bar so that a more accurate position can be found, as again denoted by still greater reading of the field strength milliammeter.

The Johnson "Q" Antenna

● Another type of single band half wave antenna is the Johnson "Q," which uses a special quarter wave matching transformer to couple a more or less conventional 400 to 600 ohm two-wire line to the 73 ohm impedance which exists at the center of a half wave antenna. This matching transformer consists of two parallel aluminum tubes, each a quarter wave in length, suspended from the center of the antenna. See Figs. 25 and 26.

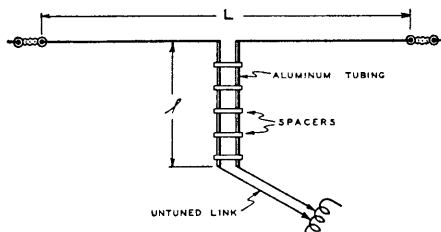

JOHNSON "Q" ANTENNA

Fig. 25

The surge impedance is made fairly low by using half-inch diameter tubing, spaced 1.6 inches apart. This spacing results in an impedance of slightly over 200 ohms, which is the geometric mean between the antenna center impedance of 73 ohms and the impedance of a two-wire line of 600 ohms. The matching section should be approximately a quarter wave in length for the particular frequency used.

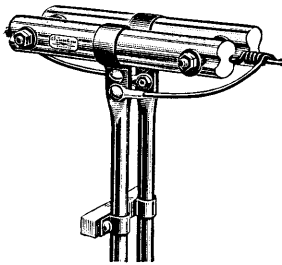

Fig. 26
Pictorial Sketch of Johnson "Q."

The design formulas are as follows:

$$L \text{ (in feet)} = \frac{467,000}{f}$$

$$l \text{ (in feet)} = \frac{246,000}{f}$$

where L is the antenna length in feet.
 l is the matching section length in feet.
 f is the frequency in kilocycles.

This antenna is quite widely used on 20 meters because of its relatively high efficiency. The 600 ohm untuned or non-resonant line can be of any length and should be connected across the equivalent of 600 ohms of impedance at the transmitter.

The Collins Multi-Band Antenna

● This antenna system is a special form of Zepp antenna suitable for operation on several bands. The losses are less in dry weather, and even in wet weather it should be a comparable system to the Zepp antenna. It consists of a half wave antenna at the lowest frequency of operation, with parallel copper tubing quarter wave feeders connected in the center of the antenna. See Figs 27 and 28. The system can be used on harmonics because of the special form of RF feeders which are used.

The center impedance of a half wave antenna is approximately 75 ohms; the center impedance of a full wave antenna is about 1200 ohms. Consequently the RF feeder is designed to have an impedance which is the geometric mean of these two values, or 300 ohms. This value of 300 ohms is obtained by using quarter-inch copper tubing with 1½-inch spacing, held in position with small ceramic separators. The impedance mismatch between 300 ohms and 75 or 1200 ohms is 4-to-1, which is not

great enough to cause excessive values of standing waves on the feeders. The line is made a multiple of quarter waves in length and thus the reactance at the station end is negligible; it will provide a resistive impedance of 75 or 1200 ohms. A simple untuned pickup coil (variable turns) is suitable for coupling to the transmitter or receiver tuned circuits. The design formulas are as follows:

$$\text{Antenna length in ft.} = L = \frac{(k - .05) 492,000}{f}$$

$$\text{Feeder length in feet} = l = \frac{234,000 m}{f}$$

Where k = number of half wavelengths.
 f = frequency in kilocycles.
 m = number of quarter wavelengths.

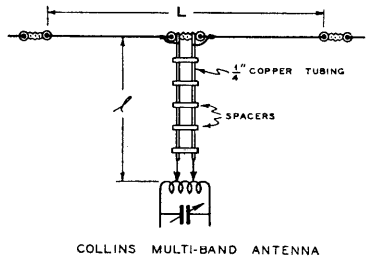

Fig. 27

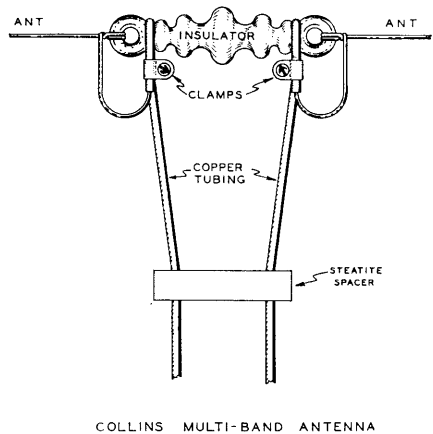

Fig. 28
Close-Up of Center of Antenna, Showing Feeder Connections.

Collins Multi-Band Antenna

CHART FOR COLLINS MULTI-BAND ANTENNA

Antenna	A	B	C	D	E	F	G
Antenna Length in Feet	136	136	275½	250	67	67	103
Feeder Length in Feet	66	115	99	122	65	98	82½
Frequency Range in Megacycles	3.7—4.0 7.0—7.3 14.0—14.4	3.7—4.0 14.0—14.4	1.7—2.0 3.7—4.0 7.0—7.3 14.0—14.4	1.7—2.0 3.7—4.0	7.0—7.3 14.0—14.4 28.0—29.0	7.0—7.3 14.0—14.4 28.0—29.0	3.7—4.0 7.0—7.3 14.0—14.4
Nominal Input Impedance in Ohms	1200 all bands	75 all bands	1200 160—80— 20M., and 75 on 40M.	1200 all bands	75 on 40M. 1200 on 20 and 10M.	1200 all bands	1200 all bands

The efficiency of the feeders may run as high as 97% in spite of the impedance mismatch. The feeders weigh approximately 10 pounds and they hang from the center of the antenna, therefore the antenna wire should be copper-clad steel under tension, unless a support in the form of a mast is placed at the center of the antenna. A study of the antenna chart will indicate several possibilities for amateur installation.

Zepp Antenna

● This antenna consists of a half wave section with tuned feeders connected to the end, Fig. 29, or into the center, Fig. 30, of the half wave radiating section.

The purpose of the feeders is to permit the erection of an antenna as high above ground and as clear from nearby objects as possible. The feeders transfer radio-frequency power from the final amplifier of the transmitter to the radiating portion of the antenna. The portion of the antenna called the *Zepp Feeder* (which is a resonant coupling device, and thus forms part of the antenna proper) simply consists of an additional length of antenna which is folded back upon itself in such a way that the standing waves on the two feeders neutralize each other, thus preventing the feeder portion of the antenna from radiating. The first fundamental of Zepp Antenna design is that the flat top portion must be cut to within 10% for the frequency used. Variations of less than 10% can be compensated for by tuning the feeders in the radio room.

When one wire of a Zepp Feeder is con-

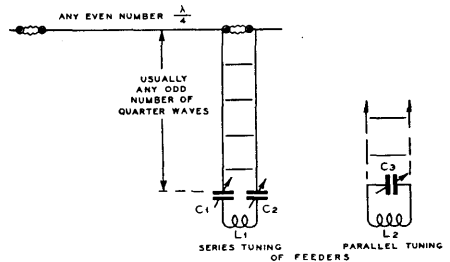

Fig. 29

Zepp Antenna System and Feeder Tuning Methods.

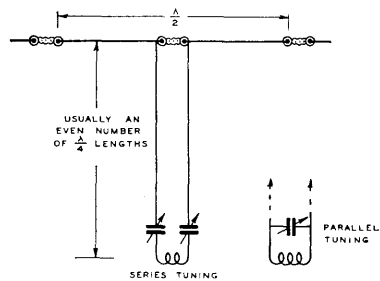

Fig. 30

Zepp Feeders Connected in Center of Half Wave Antenna.

nected to the end of a half wave antenna the feeders should be some odd multiple of quarter wavelengths long, because the two wires folded back on each other form half wave resonant sections. The coupling coil and tuning condensers in the feeder circuit

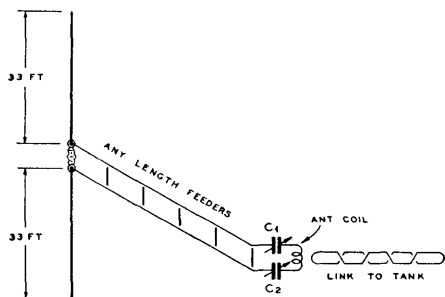

Fig. 30-A

20 and 40 Meter Vertical Antenna with Zepp Feeders. C1-C2 Are .00025 mfd. Condensers.

are part of the tuned feeder system. If the physical length of the two feeders is either longer or shorter than an odd multiple (1, 3, 5, etc.) of quarter waves, this length can be made electrically correct by varying the number of turns on the coupling coil or the capacity of the feeder tuning condensers. Thus when Zepp Feeders are tuned, merely their electrical length is varied. The presence of the coupling coil, or coils, adds electrical length which may be offset by using tuning condensers which reduce the electrical length. Sometimes combinations of series and parallel tuning are necessary when operating a Zepp Antenna on more than one band. If the physical length of the feeders, plus the inductance of the coupling coil is less than a quarter wave, or slightly less than three quarters of a wave, it is necessary to use parallel tuning for the feeders. If the physical length of the feeders is somewhat *greater* than a quarter wave, or three quarters of a wave, the feeders must be tuned with series condensers.

Not all Zepp feeders have coupling coils and tuning condensers; instead, a short-circuiting bar or copper wire can be shunted across the two feeders at the lower end to complete the circuit. In this type of construction the feeders are tuned by sliding the bar up or down across the feeders until resonance is established. Coupling to the transmitter is accomplished by a non-resonant line connected to the resonant feeders at the proper impedance matching points.

Zepp Feeder Spacing

● The spacing between the two wires of the Zepp feeder should be about 6 inches. Glazed ceramic feeder separators which resist moisture absorption should be used to maintain proper spacing between the two wires. If the spacing is too great, the standing waves on the feeders do not properly neutralize each other and excessive feeder radiation will result. If the spacing is too small,

there will be excessive loss at the feeder separators along that portion where high radio-frequency voltage exists.

Directional Effects of Zepp Antenna

● When the Zepp antenna is operated on its fundamental frequency, the main portion of the radiation is at right angles to the direction of the wire. For operation at higher frequencies (harmonics), the curves of Fig. 8 indicate the optimum directions for transmitting or receiving.

SUMMARY

● The principal advantage of the Zepp Feeder system is that, no matter how inefficiently it may be built, power will always be drawn from the final amplifier. The power radiated may be only a small fraction of the energy conveyed in transit. Because a Zepp feeder system draws the greatest amount of power from the final amplifier, and gives the greatest meter indication of RF current, is no indication that the system is working efficiently. Other forms of coupling devices usually refuse to draw power from the final amplifier unless the radiating portion of the antenna is functioning properly. Sometimes it is assumed that the non-resonant transmission line is faulty and difficult to adjust because the final amplifier cannot be made to draw enough plate current; however, the fault may be traced to the antenna not having the proper length for operation on the desired frequency. In other words, an effective non-resonant transmission line will ordinarily draw no power from the transmitter *unless it can deliver it to the antenna.*

The most outstanding feature of the Zepp coupling system is its simplicity and ease of adjustment. It is *less efficient* than most non-resonant transmission lines. Theoretically, Zepp feeders do not radiate, but, as a matter of fact, the perfect Zepp feeder exists only on paper.

Another advantage of the Zepp feeder lies in the fact that it can be used for operation on several bands.

Construction

● Zepp feeders should be cut as closely as possible to an odd number of quarter wavelengths long for connection to the end of an antenna, or an even number of quarter wavelengths for connection into the center of a half wave antenna. The feeders should be supported in the clear, and no sharp bends should be tolerated. If the feeders are within one foot of such objects as a stucco wall or other structure in which there is predominance of metal, as much as 50% of the power from the transmitter can be wasted by absorption.

Zepp Antenna System

Center-Fed Zepp

● This system differs from the more-common voltage fed type in that it connects to a low impedance point on the antenna instead of at a high impedance point. For this reason it is sometimes known as the *Current Fed Zepp*, or *Doublet*, whereas the more-common type is known as the *Voltage Fed Antenna*. The Center-Fed system provides a better balance because both wires connect into the antenna, whereas the end connection leaves one feeder wire unterminated, resulting in some unbalance of current in the two feeder wires. The directional effect of either system is the same for operation on the fundamental wavelength. When the center-fed system is operated on the second harmonic the flat top portion becomes two voltage fed half wave antennas in phase. This produces an increased directional effect at right angles to the direction of the antenna wire, instead of a four-leaf clover effect which is otherwise obtained when the end-connection is used.

Voltage-Fed vs. Current-Fed

● *Voltage-fed*: The Zepp feeders are connected to the radiating portion at points of high RF voltage. These points exist at the ends of each half wave section, due to standing wave effects.

Current-fed: Connection is into the half wave section at a point of low impedance and high current. Since the voltage and current are approximately 180 degrees out of phase, the point of *maximum* current occurs at the point of *minimum* voltage. See Fig. 30. This point exists at the center of each half wave section for the particular frequency used. In this discussion half wave sections are referred to the particular band in use, such as 130 feet for the 80 meter band, approximately 66 feet for the 40 meter band, and 33 feet for the 20 meter band.

Length of Any Half Wave Antenna

● Antennas which are fed by any type of non-resonant line must be cut to exact length, subject to modification due to the presence of nearby objects. For all practical purposes, the antenna can be cut to the calculated length and the wire should be of a kind that does not stretch. If the wavelength of operation is known, the length can be calculated by multiplying the wavelength by 1.56, giving the result in feet.

$$L = 1.56 \times \lambda$$

where L = length in feet,

λ = wavelength of transmitter.

If the frequency of operation is known, the antenna length in feet can be calculated by dividing the frequency in kilocycles into 492,000.

$$L = \frac{492,000}{f}$$

where L = length in feet,

f = transmitter frequency in kilocycles.

These formulas do not apply for long wire antennas.

The values calculated for a Zepp antenna are not critical, and if the flat top portion is within 10% of these values the error can be compensated for by tuning the feeder system. The old popular conception that a Zepp antenna must be cut to exact length is erroneous. No matter how close an antenna is cut to prescribed length the proximity of nearby objects will often change the effective electrical length as much as 5% or 10%. Herein lies one of the advantages of the Zepp antenna, since the antenna can be tuned to exact resonance at the transmitter.

LENGTH OF FEEDERS	Type of Feeder Tuning to Use
Up to One Quarter Wave	Parallel Tuning
Between One and Two Quarter Waves	Series Tuning
Between Two and Three Quarter Waves	Parallel Tuning
Between Three and Four Quarter Waves	Series Tuning
Between Four and Five Quarter Waves	Parallel Tuning
Between Five and Six Quarter Waves	Series Tuning

Zepp Feeder Tuning Chart

For 5 meters one quarter wave is	4 ft.
For 10 meters one quarter wave is	8 ft.
For 20 meters one quarter wave is	16 ft.
For 40 meters one quarter wave is	33 ft.
For 80 meters one quarter wave is	66 ft.
For 160 meters one quarter wave is	132 ft.

For Half Wave Zepp Flat-Tops

Zepp Feeder Lengths

Band	Length of Flat-Top
160 meters	250 feet
80 meters	130 feet
40 meters	66 feet
20 meters	33 feet
10 meters	16.5 feet
5 meters	8 feet

Two Wire Matched Impedance Antenna

● This antenna is useful only for one-band operation, but it is more efficient than a single wire fed antenna. It consists of a half wave section with the two feeders connected to each side of center, as shown in Fig. 31. This method of feeder connection provides the incorrect phase relation for harmonic operation. It is often used for 5-meter communication and is quite effective on 10 and 20 meters.

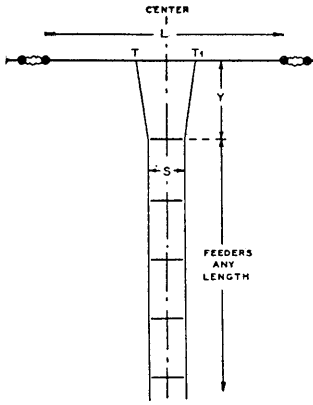

Fig. 31

Two Wire Matched Impedance Antenna System.

The surge impedance of a two wire line can be calculated from the formula:

$$Z_s = 276 \log_{10} \frac{b}{a}$$

where Z_s is the surge impedance in ohms.
 a is the radius of the wire.
 b is the distance between the two wires.

Since the impedance of an antenna depends upon the points between which measurement is made, and varies from a low value at the center to a very high value at the ends of the antenna, the line must be tapped to the antenna at points where the impedance is equal to the impedance of the line. With the ordinary type of two wire line it is necessary to fan-out the feeders at the far end to evenly increase or transform the feeder impedance so that it matches the antenna. The details of this matching impedance between the 600 ohm line and a half wave antenna are figured as follows:

$$L \text{ (in feet)} = \frac{492,000}{f} \times 0.95$$

where L is the antenna length.
 f is the frequency in kilocycles.

The portion of the antenna between the two taps, T and T_1 where the feeders connect is computed as follows:

$$T \text{ to } T_1 \text{ (in feet)} = \frac{492,000}{f} \times 0.24$$

The fanned-out "Y" portion is computed as follows:

$$Y \text{ (in feet)} = \frac{147,000}{f}$$

The feeder spacing "S" for a 600 ohm two wire line is computed approximately as follows:

$$S = 150 \times r$$

where S is the center-to-center distance between the wires, r is the radius of the wires.

These should be expressed in the same units, whether in inches or centimeters. The spacing of the feeders is rather critical and the line must be kept taut. Each side of the line must be of the same length and symmetrical with respect to ground. The transmission line should be connected at right-angles to the antenna for a distance at least equal to one-third of the antenna length. Bends in the feed line should be gradual because sharp bends cause reflection losses and undesired feeder radiation.

Feeder Adjustment

● The antenna length and taps T and T_1 should be adjusted for actual operating conditions in order to minimize standing wave effects on the transmission line. If the feeders are of bare copper wires a small RF milliammeter can be bridged across approximately one foot of wire with a pair of wire hooks, as illustrated in Fig. 32. This de-

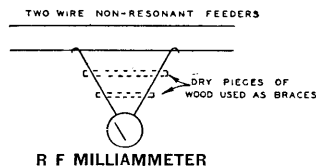

Fig. 32

Method for Locating Standing Waves on Two Wire Non-Resonant Feeder.

vice can be moved along a quarter wave section of the RF feeder to check for standing waves. The current will be constant if

End Fed Antenna

no standing waves are present. A more practical device is illustrated in Fig. 95. It can be carried along the feed line, close enough to it so that RF energy coupled into the pickup coil will give an indication on the meter scale. Sometimes the proximity of buildings, trees or antenna towers will affect the electrical length of the half wave antenna. One side of the antenna must sometimes be slightly shorter than the other, in order to eliminate standing waves on the feed line. The positions of the taps T1 and T2 can be moved to obtain this effect after the antenna itself is pruned to exact length for the frequency of operation.

The directive properties of this antenna are such that best results are secured in the direction at right angles to the flat top wire. For ultra-short-wave operation the antenna portion is usually made vertical, and reflector systems are often employed to increase the radiation in the desired direction.

The End Feed Antenna

● When a half wave antenna, or one with multiples of half waves, has one end brought directly to the radio transmitter it is called an *End Fed Antenna*, or *Fuchs Antenna*. These antennas can be operated on several bands with almost equal efficiency. Their main disadvantage lies in the fact that the antenna is brought directly into the radio room, therefore a material portion of the radiation may be lost by the nearness of loss-creating objects. It is an easy antenna to tune because there are no RF feeders which require adjustment, and the electrical length can be varied at the transmitter in order to obtain exact resonance on any band.

The antenna should have an overall length of an even number of quarter waves in length. By making it a trifle too long, the far end can later be "pruned" until exact resonance is obtained. The tuning process consists of operating the final amplifier of the transmitter at reduced power, tuning it to resonance, and then tapping the antenna across part of the final amplifier plate coil. The antenna should be of such length that no change in the plate tuning condenser is necessary in order to obtain resonance in the amplifier either with or without the antenna connected to the amplifier.

A series coil and condenser, when connected in the antenna near the end, will tune the antenna to resonance for different frequencies. See Fig. 33. Slight errors in length can be compensated for by adjusting the parallel tuned coupling circuit. If the antenna is cut to the correct length this

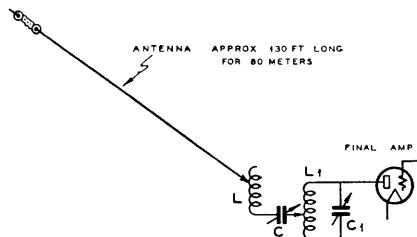

Fig. 33
End Fed Antenna with Series Tuning Circuit.

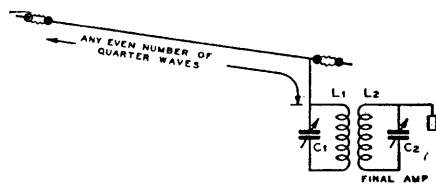

Fig. 34
End Fed. Voltage Fed Hertz Antenna.

coupling circuit will be tuned to exactly the same frequency as that of the final amplifier plate circuit, shown in Fig. 34.

When an end fed antenna designed for 80 meter operation is used on 160 meters it becomes a Marconi antenna, as shown in Figs. 35 and 36. A good ground connection is necessary. The antenna coupling coil should have approximately 20 turns of wire, wound on a form approximately the same diameter as the final amplifier plate coil. The coupling should be variable.

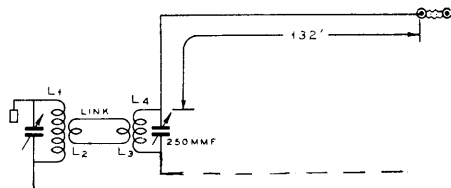

Fig. 35
80 Meter End Fed Antenna with Counterpoise for 160 Meter Operation.

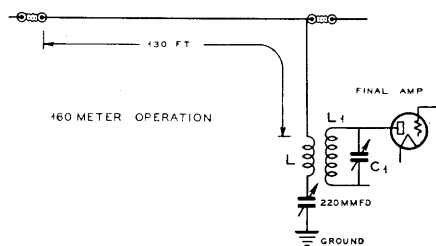

Fig. 36
80 Meter End Fed Antenna with Loading Coil for 160 Meter Operation.

The directional effects of this antenna are similar to those shown in Fig. 8, except when operated on 160 meters. If the antenna stretches out nearly horizontal from the transmitter, these directive patterns are approximately correct. This antenna is most practical for operation where the radio transmitter is located on the top floor of a building. The losses are apt to be excessive if the antenna runs close to the side of a building and into a radio transmitter located near the ground.

The approximate length of the antenna is determined from the formula:

$$L = \frac{492,000}{f}$$

where L is the length in feet of the antenna, f is the frequency in kilocycles.

Long Single Wire Antenna

● Remarkable results for both transmitting and receiving can be secured with a long antenna operated on its harmonics. This antenna is more directional than a half wave antenna. It should be pointed more nearly in the direction in which general long-distance communication is desired. The

If the end of the antenna is brought into the operating room, the system can be tuned to exact resonance for any desired harmonic. Zepp feeders are also very suitable for this type of antenna. A study of the "V" Antenna Design Table will show that an antenna 552 feet long for 7100 KC does not resonate at twice that frequency for 20 meter operation, rather it is resonant at 14,250 KC. Zepp. feeder tuning, or end feed tuning adjustments, will make possible the resonating of the antenna at 14,200 KC if operation from one crystal is wanted for both the 20 and 40 meter bands.

Several of these antennas can be strung in various directions because great height is not absolutely essential.

Twisted Pair Fed Antenna

● A very effective one-band antenna for transmitting and receiving consists of a half wave flat top with a twisted pair feeder. The impedance of a twisted pair ranges from 80 to 175 ohms, depending upon the spacing between the conductors and the diameter of the wire. This impedance is low enough so that the feeders can be connected directly into the center of the antenna. In practice, the last few inches of the feeders are fanned-out into a small triangle, as shown in Fig. 37.

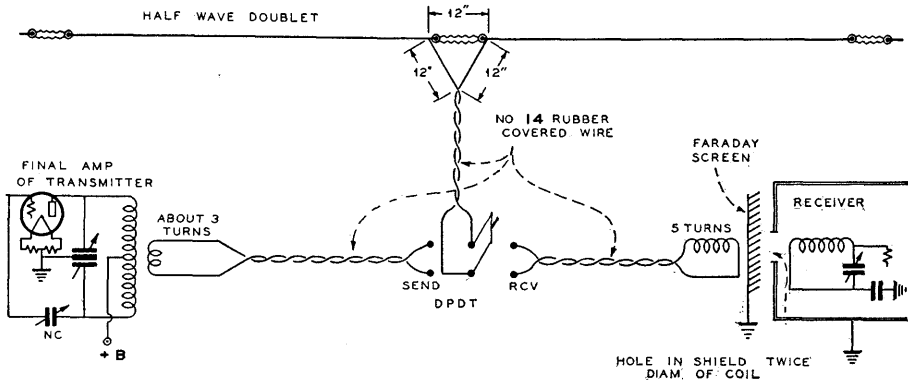

Fig. 37
One-Band Doublet Antenna for Transmitting and Receiving.

horizontal directivity diagrams previously shown in Fig. 11 indicate the main directions of greatest radiation. An actual gain of from 2 to 4 times is obtained by making the wire from 4 to 8 waves in length. Even shorter lengths will provide very noticeable gain, such as can be obtained by a 275-foot wire on 40 meters. This same antenna will be even more effective on 20 meters, but somewhat more directional in the line of the wire. The dimensions for these long wire antennas can be obtained from the Table, "V" Antenna Design.

The feeder can be any length, and it can be carried around corners of buildings, through walls and along picture mouldings. Nearby objects have very little effect on the efficiency of the feeders because of their close spacing and the large number of transpositions or twists along the feed line. The losses in the feed line are exceptionally low, largely because the small spacing between the wires causes the line to have a very low characteristic impedance. This means that for a given amount of power the voltage between the two wires is very low,

Antenna Loading Systems

thus insulation and dielectric losses can be held to a minimum. Ordinary stranded lamp-cord should be avoided because of high losses, but single conductor No. 12 to No. 18 twisted pair is satisfactory. The special twisted pair made for RCA double-doublet antennas is satisfactory for power inputs of several hundred watts. Type E01 twisted pair, available from most radio dealers, is designed for an 80 ohm impedance and will handle powers up to 1 KW. These commercially made twisted pairs are covered with a special grade of rubber which has a low dielectric loss and is quite resistant to weather.

Harmonic operation is not recommended because the line is no longer non-resonant for such operation, and standing waves will cause high RF voltage across some portions of the line. If much power input is used, the line insulation will break down and burn. Operation on the second harmonic is possible, but the efficiency of the line then drops approximately 50%. This antenna is excellent for receiving because of reduction in noise pickup. Two of these antennas placed at right angles to each other will provide transmission or reception in all directions.

Problems of Space Limitations

● Countless experimenters are faced with the problem of erecting an antenna in a space too small for a half wave antenna of the desired frequency of operation. For example, only 90 feet of space may be available, yet operation on 75 meter phone would require an antenna approximately 125 feet long. Certain forms of *Marconi Antennas* can be used, since these are a quarter wave in length, or approximately 63 feet. A counterpoise or a good ground connection would be required, and by this means fairly satisfactory results can be obtained. A half wave antenna which is horizontal over its entire length is often preferable from a standpoint of its directivity and efficiency. Such a half wave antenna can be built into a 90 foot space by using an *end loading coil* to make it an electrical half wave in length, as illustrated in Fig. 38. The loading coil can be wound with approximately one-fourth to one-half as much wire as would normally be used for the antenna, in this case, 125 feet long; approximately 10 to 15 feet of wire would therefore be wound on the loading coil. The winding form can be from 2 to 3 inches in diameter and the coil should be space wound with the same size and kind of wire as the antenna. The loading coil should be covered with a weather-proof housing and the antenna strain should be taken up with strain insulators, rather than depending upon the coil form to act as

Chart Showing Theoretical Length of Half Wave Antennas, Such as Single Wire Fed, Collins, Johnson "Q," Matched Impedance, Twisted Pair and Zepp.

BAND	Frequency	Antenna Length
1¼ Meter	224 mc	25'
	232 mc	24'
	240 mc	23.5'
2½ Meter	112 mc	4' 2"
	116 mc	4'
	120 mc	3' 10"
5 Meter	56 mc	8' 4"
	58 mc	8' 1"
	60 mc	7' 10"
10 Meter	28 mc	16' 8"
	29 mc	16' 1"
	30 mc	15' 6½"
20 Meter	14.05 mc	33' 4"
	14.15 mc	33' 1"
	14.25 mc	32' 10"
	14.35 mc	32' 8"
40 Meter	7.02 mc	66' 7"
	7.10 mc	65' 9"
	7.20 mc	64' 11"
	7.28 mc	64'
80 Meter	3550 KC	131' 6"
	3600 KC	129' 10"
	3700 KC	126' 4"
	3800 KC	123'
	3950 KC	118' 4"
160 Meter	1750 KC	267'
	1850 KC	252'
	2000 KC	233'

a strain support for the antenna. The newer forms of low-loss tank coils wound on celluloid strips should be suitable in locations

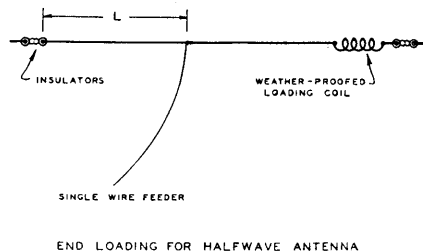

Fig. 38

where snow and ice are not encountered, thus they need not be protected from the weather.

A single wire feeder or Zepp. feeder can

be used for this type of antenna, and in the case of a single wire feeder the distance L in Fig. 38 should be one-third the length which a regulation half wave antenna would ordinarily have *without* the use of a loading coil. Thus the 90 foot wire previously referred to would have the single wire feeder attached to it at a point approximately 42 feet from the unloaded end, just as if it were a 125 foot length of wire. If this antenna is to be operated only on one band, the feeder tap can be moved along the flat-top until standing waves disappear from the feeder, as checked with the simple feeder tuning device described elsewhere in Fig. 95.

The approximate adjustment of the loading coil can be made with the antenna suspended only a few feet above the ground, or roof, and coupled loosely to a regenerative receiver. The natural period of the antenna can be found for each adjustment of turns on the loading coil by noting the point at which the regenerative receiver tends to pull out of oscillation, if the receiver dial is calibrated approximately in wavelength or frequency. The receiving antenna for these tests can be a short wire a few inches from the antenna under test, with just enough coupling between the two antennas to tend to stop oscillation in the receiver at resonance. Another method of tuning the antenna system is to use an antenna field strength meter connected to a small antenna, parallel to the antenna under test. In this case the transmitter should be coupled to the main antenna and constant power input maintained to the final amplifier. The field strength meter reading will be a maximum when the antenna is correctly loaded to the frequency of operation.

Another example of end loading would be for a half wave antenna for the 40 meter band, built into a space of only 50 or 60 feet. Normally, such an antenna with its insulators and supports would require a space of at least 70 feet. The loading coil will permit successful operation of a 45 or 50 foot flat-top without great sacrifice in efficiency.

160 Meter Coupling Systems

● A simplified PI coupling system is shown in Fig. 39.

The 150 mmfd. and the 500 mmfd. variable condensers are effectively in series, through the common chassis ground connection. The advantages of this arrangement are: (1) there is no DC on the tuning condensers and the condensers will not flash-over on modulation peaks; (2) there is freedom from filter and rectifier trouble; (3) closer spaced tuning condensers can be

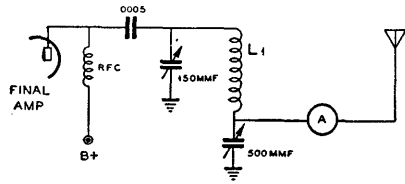

Fig. 39

A Simplified Antenna Coupling System. The 500 mmf. condenser is an ordinary receiving type variable condenser; the 150 mmf. condenser is of the high-voltage type.

used; (4) ample leeway for the tuning circuit because large variable condensers are used. The plate coil L_1 consists of 60 turns of No. 20DCC wire, close wound, on a 2-inch diameter form, tapped at the 40th, 50th and 60th turn.

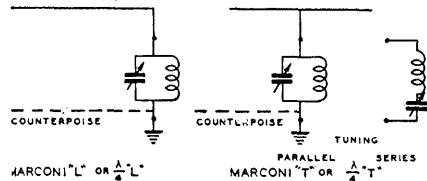

Fig. 40

Fig. 41

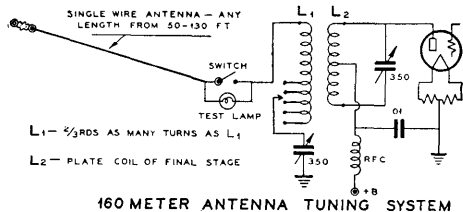
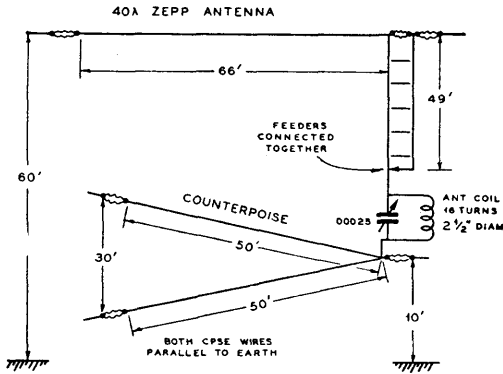

Fig. 42

The circuit shows the use of a tuning lamp in series with the antenna and a shorting switch for bridging the lamp after the antenna is tuned. A better method is to merely wrap a turn or two of wire around the lead-in wire and connect the ends of the loop to the lamp. The lamp can then be left permanently in the circuit.

Fig. 40 shows the common inverted-L Marconi antenna using parallel tuning of the pick-up coil. Fig. 41 shows the same antenna in a T-form, instead of an inverted-L. Practically all 160-meter antennas are of the quarter wave type and are similar to those used in the broadcast band for either transmission or reception.

FIG. 43—How to Use a 40 Meter Zepp Fed Hertz on 160 Meters



The illustration shows a 40 meter Zepp fed Hertz antenna for operation in the 160 meter band. A counterpoise, about 10 feet above earth, completes the circuit to ground and makes a Marconi, or quarter wave grounded antenna out of the combination. The Zepp feeders are connected together and attached to the turning condenser and to one end of the antenna coupling coil, as shown. The other end of the coupling coil connects to the counterpoise. If the feeders are not of the same length as those shown in the diagram, the number of turns on the coupling coil must be changed in order to establish resonance. The coupling coil should be loosely coupled to the

tank circuit of the transmitter. For 40 meter operation, the Zepp feeders are adjusted in the usual manner with the coil and condensers, and the counterpoise is not used.

Marconi Antennas

● Marconi antennas are widely used on the 160 meter band and for longer wave commercial communication. For 160 meter operation the antenna can be from 90 to 150 feet long, with series tuning coils and condensers, with the base of the antenna to a good connected ground or counterpoise. Figs. 39 to 46 shows various methods for 160 meter operation. The choice depends largely upon the individual location. It is always important to keep the lead-in and coupling coil remote from all house wiring and metal objects in order to minimize losses. Grounds can be replaced with a counterpoise of one or more wires; usually a network of wires in the counterpoise is more effective because of greater capacity to ground. A Marconi antenna for 160 meters can be adjusted by using series tuning coils and a series variable condenser of from .00025 to .0005mfd. Resonance is obtained by switching taps and by varying the condenser until the antenna loads the plate current of the final stage to its normal value. If this value is more or less than the rating of the tube, the coupling between the loading coil and the final tank coil should be increased or decreased.

The radiation resistance of a quarter wave Marconi antenna at the point of ground connection is less than 35 ohms. The ground connection should have low resistance in order to convert the power into useful radiation, rather than into resistance heat losses. A Marconi antenna less than

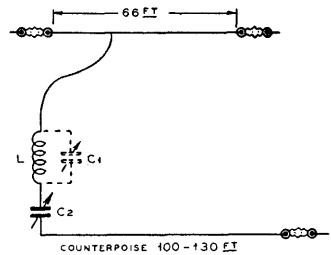

Fig. 44

40-Meter Single Wire Fed Hertz for 160 Meter Operation. If "L" has sufficient turns, C1 is not required. "L" is coupled to the plate tank circuit.

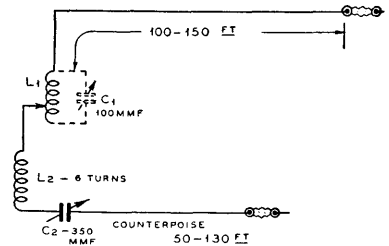

Fig. 45

Another System for Loading an Antenna for 160 Meter Operation.

a quarter wave long has even lower values of radiation resistance; values of from 5 to 30 ohms have been encountered with an-

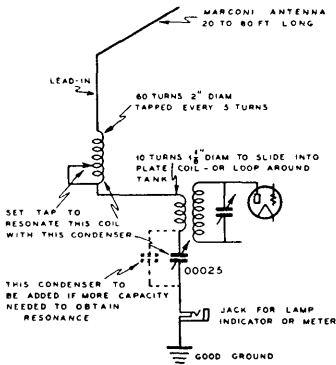

Fig. 46
Loading System for Short Marconi Antenna
for Boats, Aeroplanes, Etc.

tennas from 1/16th to 1/5th of a wave in length.

These low values of impedance make it impossible to use the *Collins Pi Antenna Network*. Such antennas must be loaded to a quarter wave, electrically, by means of loading coils, and in some cases the loading coil must be shunted with a variable condenser in order to obtain resonance. These very short Marconi antennas (such as installed on small sea-going craft, see Fig. 46), require a very low resistance connection to the ground or counterpoise in order to avoid excessive power losses.

Directive Antennas

● All antennas have directional properties and these can be increased by properly combining the antenna elements. The various forms of half wave antennas already described have maximum radiation out at right angles to the direction of the wire, but the directional effect is not very great. If this radiation can be confined to a narrow beam, the signal intensity can be increased a great many times in the desired direction of transmission. This is equivalent to increasing the power output of the transmitter. It is more economical to use a directive antenna than to increase transmitter power if general coverage is not desired.

Directive antennas can be designed to give as high as 23 DB gain over that of a single half wave antenna. However, this high gain (nearly 200 times as much power) is confined to such a narrow beam that it can be used only for commercial applications in point-to-point communication. The increase in radiated power in the desired direction is obtained with a corresponding loss in all other directions. Gains of 3 to 10 DB seem to be of more practical value for amateur communication because

the angle covered by the beam is wide enough to sweep a fairly large area. 3 to 10 DB means the equivalent of increasing power from 2 to 10 times. For example, an amateur living in the center of the United States would want his beam to be wide enough to cover all of Europe in one direction, and New Zealand in the opposite direction. His beam should be centered about 45° north-of-east, and about 35° wide. Similarly, a 20° beam width, 50° south-of-east, would cover South America and the Orient. Another 35° beam pointing east and west would cover Australia and South Africa. In San Francisco, two beam antennas could be made to cover all DX sections fairly well; a 30° beam, 35° south-of-east for South America and the Orient, and another 35° to 40° beam, 45° north-of-east for Europe, New Zealand and Australia.

In this discussion all antenna arrays are assumed to have two main lobes of radiation in opposite directions (no reflector system). Angles in which the antennas could be pointed can be figured as the Great Circle shortest distance direction with the aid of a globe of the world. Day and night directions in some cases are different, due to the skip distance effects of some of the high-frequency bands, because the signals may go around the world in one direction in the morning, and in the other direction at night, to points near the opposite sides of the world.

Four to six half wave antennas or their equivalent are apparently about all that can be used without securing too much directivity, unless the operator is aiming at one locality of relatively small area. With ultra-short wavelengths below 10 meters, the problem of rotating the beam antenna is simplified and more directional effects with greater power are desirable. Reflector systems can be set up for increasing the beam in one direction and preventing radiation in the opposite direction.

Tables of wire lengths for several arrays and directional types of antennas are given. Local conditions of surroundings will modify these values, but for most purposes the wires can be cut to the values listed, and satisfactory results obtained.

The most simple method of feeding many types of directional antennas (if near the transmitter) is by means of Zepp feeders which are generally some old multiple of quarter waves in length. In all cases where the system is much more than a wavelength from the transmitter to the feed point, a non-resonant two-wire feeder and quarter wave matching stub should be employed. The problem is greatly simplified in most cases by the use of Zepp feeders, since the feeders can be tuned at the transmitter just as with any Zepp half wave antenna. In some instances the feeders should be electrically an even multiple of

Antenna Directivity

quarter waves in length. A simple field strength meter coupled to the antenna system will readily indicate correct feeder tuning.

All directional resonant antenna systems, other than a single long wire system, operate on the one frequency for which they are designed. The "V" beam can be operated on two bands with fair satisfaction, although the correct angle δ between the arms of the "V" can only be made for one frequency. A type is generally chosen from a consideration of available space. The "V" beams are less critical in mechanical design; if space is available for pointing the open or closed end of the "V" in the desired direction, this type is excellent.

Horizontal and Vertical Directivity

● The horizontal directivity of any antenna system is that shape of the radiated beam or beams shown looking down at the earth from a point above the antenna system. For example, a beam having a width of 30° horizontally would spread out enough to cover a whole continent, such as Europe, from points in the United States. *Vertical Directivity* is the expression for defining the angle above the horizon at which the major portion of the radiation goes out from the antenna. Directional antenna systems are generally made to have a very low angle of radiation, so that the vertical directivity is outward toward the horizon, rather than upward.

Polarization

● Radio waves are *Polarized* in that they will induce a greater signal in the receiving antenna when the plane of that antenna is parallel to the plane of polarization. For example, a vertical transmitting antenna will produce a vertically-polarized wave which can best be received by a vertical receiving antenna over relatively short distances, such as in the ultra-high-frequency region. Wave-lengths between 10 and 100 meters can be transmitted with either vertical or horizontal antennas, resulting in the wave starting out with a *vertical* or *horizontal* polarization, and by the time it reaches the distant receiving antenna it is apt to be mainly *horizontally* polarized. Reflection and refraction effects in the Heaviside Layer tend to twist the wave polarization so that in most cases a horizontal receiving antenna will give best results.

For ultra-short wavelengths, vertically polarized waves are not reflected upward by the surface of the earth as easily as those of horizontally polarized nature and only the ground wave is useful on wave-lengths below 10 meters. Vertical trans-

mitting and receiving antennas have thus proven most satisfactory at these frequencies.

Wavelengths above 100 meters are not as easily twisted as those below 100 meters. With ultra-short wavelengths the plane of polarization may be twisted by such objects as hills or buildings, so that occasionally a horizontal antenna will very efficiently receive signals transmitted by a vertical antenna.

Directive Factors

● Directional antenna systems operate on the principle that the radiation fields add or subtract in space. When several radiating elements, such as half wave antenna, are in close proximity to one another, the radiated fields may aid or oppose each other in different directions. In those directions in which opposition or cancellation occur, the signal is attenuated; similarly in those directions in which the fields aid each other, or add, the signal is increased. All directive antennas depend upon this phenomena. The fields are said to be *in phase* when they are additive, and *out of phase* when they cancel each other. Antenna directivity results from phasing the radiation from adjacent antenna elements so as to neutralize the radiation in the undesired directions, and to reinforce the radiation in the desired direction. Directivity can be obtained in either horizontal or vertical planes. In transmission, directive antennas concentrate energy much like reflectors and lenses concentrate light rays. For receiving, the signal is proportional to the amount of antenna wire exposed to the radio waves when the half wave sections are properly phased.

Reflectors

● A simple reflector consists of a wire approximately a half wave long, either excited directly by the transmitter so as to be out of phase with the antenna, or it can be of the *parasitic* type, A Parasitic Reflector one quarter wave away from the antenna must be slightly longer than the antenna in order to have an inductive reactance. The radiated field from the antenna is re-radiated by the reflector wire so that the radiation in line with the two is reinforced back toward the antenna and cancelled in the opposite direction. If the reflector wire is spaced a half wavelength distant from the antenna the radiated field will be increased in two directions, or tend to cancel in a direction at right angles. The increase is in a plane at right angles to the plane of the antenna and reflector, as shown in Fig. 47.

Two reflector wires spaced a half wave each side of an antenna, and an additional reflector spaced a quarter wave behind the

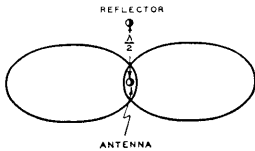

Fig. 47

antenna, will combine to increase the field intensity in a forward direction, and tend to cancel the field in all other directions.

Reflector curtains, a combination of several reflector wires in proper phase relation, are normally used in commercial applications in order to confine a beam to one direction. Without such a reflector curtain, which is usually similar to the antenna array, the beam would be transmitted with less intensity in both a forward and backward direction. The reflector in such cases *doubles* the field in the forward direction.

Parasitic reflectors have no direct connection to the antenna or feeders. Their length can be calculated from the formulas:

$$L = 1.60 \times \lambda$$

where L is the reflector length in feet.
 λ is the transmitter wavelength in meters.

$$L = \frac{492,000 \times 0.97}{f}$$

where f is the transmitter frequency in kilocycles.

These formulas can be used for determining the length of single half wave reflector wires, such as those used in a parabolic reflector or in a *Yagi* antenna.

Directors

● If a wire is placed in front of an antenna and if it has a capacitive reactance, it will aid the radiation in a *forward* direction. More than one wire may be placed in line of the desired direction, such as shown in the *Yagi* antenna in Fig. 48 in order to greatly increase the directivity and field intensity in that direction. These are called *director wires* and they are shorter than those used for reflectors. A capacitive reactance is obtained by making the wire less than an electrical half wave in length. A straight wire loses both inductance and distributed capacitance as it is decreased in length. At a given frequency the inductive reactance will predominate if the wire (less its end effects) is over a half wave in length. Similarly, if it is less than a half wave in

length the capacitive reactance will be greater than the inductance reactance. The antenna should always be resonant, in which case the inductive reactance is equal to the capacitive reactance and the two will then cancel each other.

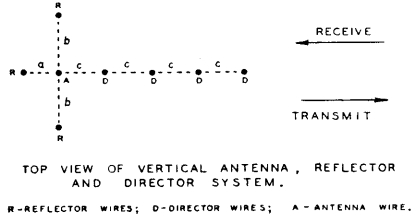

Fig. 48
Yagi Antenna.

Director wires should be spaced at intervals of $\frac{3}{8}$ ths wavelength in the desired direction from the transmitting antenna. These lengths can be calculated as follows:

$$L = 1.425 \times \lambda$$

where L is the director length in feet.
 λ is the transmitter wavelength in meters

$$L = \frac{492,000 \times 0.87}{f}$$

where f is the transmitter frequency in kilocycles.

Directional Antenna Types

The Yagi Antenna

● The *Yagi* Antenna is useful on the ultra-short and micro-wave bands. It consists of several reflector and director wires grouped around a half wave antenna, such as that shown in Fig. 48, which is a top view of a vertical array. The rear reflector wire R is placed a quarter wave behind the antenna wire A , two other reflector wires are placed a half wave from the antenna, on each side. The director wires D are spaced a distance of $\frac{3}{8}$ ths of a wave apart. The distances A , B , and C are a quarter, half and $\frac{3}{8}$ ths of a wave respectively in Fig. 48. In the accompanying table (page 34), dimensions are listed for the design of this type of directive antenna for wavelengths of from $1\frac{1}{4}$ meters to 20 meters (224 to 14.4 mc.). The reflector and director wires are all parasitically excited. The antenna can be

Franklin Antenna

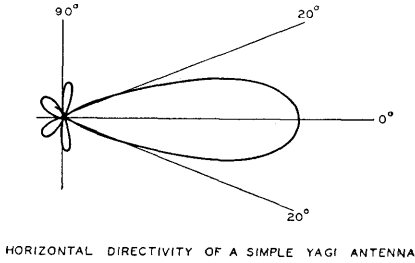

Fig. 49

fed with any type of RF feeder, such as a two-wire matched impedance feed, Zepp feeders or by a quarter wave matching stub and non-resonant line.

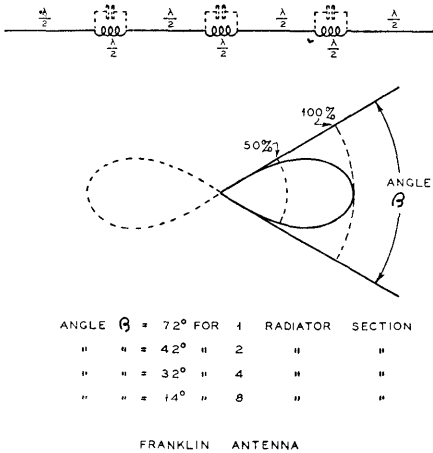

Fig. 50

The Franklin Antenna

● A directive antenna array which is quite practical for amateur application is shown in Fig. 50. It consists of two or more half wave sections in phase, so that the radiation field is broadside to the antenna. More than four sections will provide too sharp a beam for most amateur purposes. The half wave sections may be phased with quarter wave sections, as shown in Fig. 51, or by means of phasing coils, as shown in Fig. 52. In either case the phasing coil, or quarter wave section, is equivalent to a half wave antenna which does not radiate, but only serves the purpose of phasing the antenna current in the same direction in adjacent sections of the radiating antenna. The two end sections L_1 should be cut for end effects, thus making these sections slightly shorter physically than the intermediate section L_2 .

The dimensions listed in the Table for Antenna Arrays are theoretical values which may have to be slightly modified in actual practice, due to the proximity of surrounding objects. Ordinarily, this antenna can be tuned to resonance by varying the lengths of the quarter wave stubs L_3 .

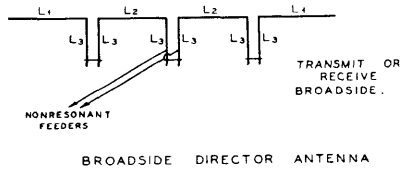

Fig. 51

Non-resonant feeders in the form of a 600 ohm line should preferably be tapped across the middle quarter wave section in order to secure a balanced antenna system. If one of these quarter wave sections is near the transmitter, it can be used as a Zepp feeder of either one-quarter or three-quarters of a wave in length. It can be tuned with series condensers and coils, as discussed under Zepp. Antennas.

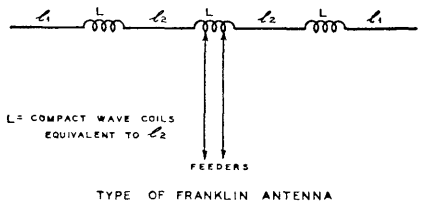

Fig. 52

A 20 meter directional antenna of this type is easily constructed because the required space is only about 135 feet, and the height above ground about 40 feet. A single 6-inch strain insulator can be used to support the L_1 and L_2 sections. The L_3 sections can hang toward the ground, held in position with a small weight. The L_2 quarter wave sections can be spaced with 6-inch standing Zepp. feeder separators. Standing waves along the non-resonant feed line can be located by means of the milliammeter, carborundum detector, and coil arrangement described in Fig. 95. The standing waves are indicated by variations of the milliammeter reading as the feeder test set is moved along the feed line at a constant distance from the line. The standing waves can be eliminated or minimized by changing the position of the feeder taps on the quarter wave section, also by a variation of the quarter wave section lengths. In some cases

the values of L_1 and L_2 may have to be shortened slightly, and the various sections may sometimes differ from the lengths shown in the Table because of the proximity of some object near one of the sections. In most cases the values shown in the Table can be used without variation, unless the utmost in efficiency is desired. The values of L_1 , L_2 , L_3 and L_4 are correct for nearly all forms of antenna arrays. This Table greatly simplifies directional antenna array design for amateur operation.

Antenna Array Dimensions

For Franklin, Bruce, Chireix-Mesny, Barrage and Stacked Dipole Arrays.

BAND	Frequency in Megacycles	L_1	L_2	L_3	L_4
40 Meter	7.02	68'2"	70'	35'	17'1"
	7.10	67'6"	69'2"	34'7"	16'11"
	7.20	66'7"	68'4"	34'2"	16'8"
	7.28	65'10"	67'6"	33'9"	16'5"
20 Meter	14.05	34'1"	35'	17'6"	8'6"
	15.15	33'10"	34'8"	17'4"	8'5"
	14.25	33'7"	34'6"	17'3"	8'5"
	14.35	33'5"	34'3"	17'1"	8'4"
10 Meter	28.0	17'1"	17'7"	8'9"	4'3"
	29.0	16'6"	17'	8'6"	4'1½"
	30.0	16'	16'5"	8'2"	4'
5 Meter	56	8'7"	8'9"	4'5"	2'2"
	58	8'3"	8'6"	4'3"	2'1"
	60	8'	8'2"	4'1"	2'
2.5 Meter	112	4'3"	4'5"	2'6"	13"
	116	4'1½"	4'3"	2'5"	12½"
	120	4'	4'1"	24½"	12"
1.25 Meter	224	25½"	26½"	13"	6½"
	232	25"	25½"	12½"	6¼"
	240	24"	24½"	12"	6"

The Bruce Antenna

● One of the simplest antenna arrays is shown in Fig. 53. It is not critical as to the length of its elements, and it can be used over a wider frequency range than most other antenna arrays. The antenna is made up of ⅛ and ¼ wave sections, resulting in good horizontal directivity if the overall length is at least five wavelengths long; however, it possesses very little vertical directivity because of its lack of height. The currents in each half of a horizontal section are out of phase and thus these sections tend to cancel their radiation field. The vertical sections are in phase, resulting in broadside radiation or reception, because this antenna is normally used for receiving. A similar bent wire, placed a quarter wave behind the antenna, will act as a reflector and make the system unidirectional.

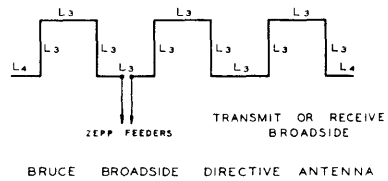

Fig. 53

This antenna is occasionally used for 5-meter transmission and reception, due to its small size. The dimensions for different amateur bands are listed in the Table showing *Antenna Array Dimensions*.

Reflector and Director Dimensions

Freq.	A	R	D	a	b	c
224	25"	26"	23"	13"	26½"	20"
232	24"	25"	22"	12½"	25½"	19"
240	23½"	24"	21"	12"	24½"	18½"
112	4'2"	4'3"	4'5½"	2'6"	4'5"	3'9"
116	4'	4'1½"	44"	2'5"	4'3"	3'8"
120	3'10"	4'	43"	24½"	4'1"	3'7"
56	8'4"	8'7"	7'½"	4'5"	8'9"	6'7"
58	8'1"	8'3"	7'4½"	4'3"	8'6"	6'4"
60	7'10"	8'	7'1½"	4'1"	8'2"	6'2"
28	16'8"	17'2"	15'3"	8'9"	17'7"	13'2"
29	16'1"	16'6"	14'9"	8'6"	17'	12'8"
30	15'6½"	16'	14'3"	8'2"	16'5"	12'4"
14.05	33'4"	34'1"	30'5"	17'6"	35'	26'3"
14.15	33'1"	33'11"	30'2"	17'4"	34'8"	26'1"
14.25	32'10"	33'8"	30'	17'3"	34'6"	25'11"
14.35	32'8"	33'5"	29'10"	17'1"	34'3"	25'8"

Stacked Dipole Antennas

● A *dipole* is simply another name for a half wave antenna. Several dipoles can be arranged in stacks to form a highly directive antenna system. When an entire "curtain" of these dipoles is used, together with a similar reflector curtain spaced one-quarter wave behind it, the beam becomes very sharp and of great intensity. Actual power gains of 100 to 200 are secured in commercial practice. Both horizontal and vertical directivity can be very great because several elements, such as shown in Fig. 54, (four radiating dipoles), can be built into a curtain with one row on top of the other. For amateur purposes the single unit will provide sufficient directivity in most cases.

The radiating sections L_1 may be either horizontal or vertical, depending on whether horizontal or vertical polarization is desired. The currents in the L_2 and L_3 sections produce fields which neutralize each other, with the result that radiation occurs only from

Directive Arrays

the L_1 sections which are a half wave in length, electrically. The actual physical length is approximately 0.975 of a half wavelength. The L_2 sections are made a half wave in length in order to provide the proper phase in the L_1 sections. In Fig. 55 the radiation is broadside to the antenna, as shown, and end-wise if the two sections L_2 do not cross.

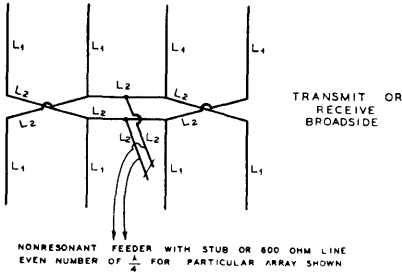

Fig. 54

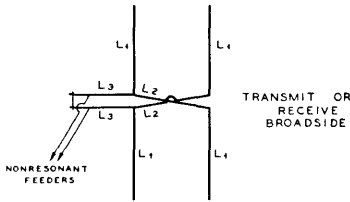

Fig. 55

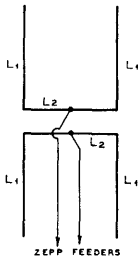

Fig. 56

In the four forms of this antenna shown in Figs. 54 to 57, quarter or half wave matching stubs provide a means of connection to a two-wire non-resonant feeder. In some cases a 600 ohm line can be connected directly into the array when the impedance at the chosen point is 600 ohms. Zepp feeders are satisfactory if they are not over 5 quarter wavelengths long. These arrays are fairly popular for the ultra-short

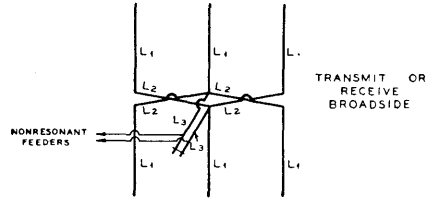

Fig. 57

wavelengths for amateur operation, although commercial application is widespread for wavelengths above 10 meters. These systems must be adjusted for the exact frequency of transmission, and quite rigidly supported.

The arrays shown in Figs. 55 and 56 are similar in performance, even though the L_2 sections do not cross or reverse in one case. The phase of the current in the L_1 sections is maintained by connection of a resonant feeder or quarter wave matching stub at the ends of L_2 in one case, and at the center in the other case.

Figure 58 shows the construction of a framework for an ultra high frequency directional antenna with parasitic reflectors spaced a quarter wave behind the "H"-section antenna. If desired, the reflector wires D can be cross-connected at their adjacent ends. The antenna sections A are listed in the Table for *Antenna Array Dimensions* as L_1 . The reflector wires D are listed in the Table for *Reflector and Director Dimensions* as D , which in this case is equivalent to L_1 . The Zepp feeders should be an even number of quarter wavelengths, the same as in a center-fed Zepp antenna.

In practical applications of curtains, the reflector wires should be tuned for maximum current. Usually the lengths will be between 2% and 5% greater than a half wave in length. The antenna elements are sometimes as much as 10% shorter than a half wave in length. The reflector curtain has a reactive effect upon the antenna and thus it is generally tuned-up first, then the antenna wires are cut to length experimentally in order to provide exact resonance under operating conditions. In these curtains, which consist of horizontal rows of half wave elements and often two or three tiers one above the other, RF power is fed in the proper phase relation to several points.

A reflector placed a quarter wave behind an antenna, and properly tuned, will provide a gain of 3 DB, which is a power gain of two. Two half wave antennas spaced a half wave apart and properly excited, will also provide a 3 DB gain over that obtained from a simple half wave antenna. Three and four half wave sections in a line a half

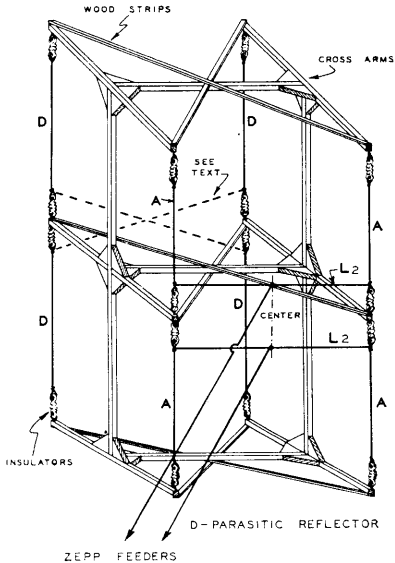

Fig. 58

wave apart will provide gains of 5 DB and $6\frac{1}{2}$ DB, respectively, over that of a single half wave antenna. The simple "H" type of stacked dipole, Fig. 55, which consists of four half wave sections, will give a gain of approximately $6\frac{1}{2}$ DB. The antenna shown in Fig. 57 which has six half wave radiating sections will give a gain of approximately $8\frac{1}{2}$ DB. The one shown in Fig. 54 which has eight sections will give a gain of 10 DB. Adding a reflector section similar to the antenna array, and spaced one-quarter wave behind it, will provide 3 DB additional gain to any of these arrays.

The Barrage Antenna

● Another of the many types of directive arrays is shown in Fig. 59, a broadside radiator of vertically polarized waves.

The horizontally polarized waves which would be radiated by the top and bottom horizontal wires are negligible because of the opposition of current flow in the two halves of each of these members. This is obtained by making the vertical sections at the top and bottom of L_2 a quarter wave long. The middle sections L_2 are half wave in length. The dimensions for this antenna are listed in the Table of *Antenna Array Dimensions* for amateur bands.

RCA Broadside Antenna

● In this array, Fig. 60, all parts of the parallel transmission line connecting the L

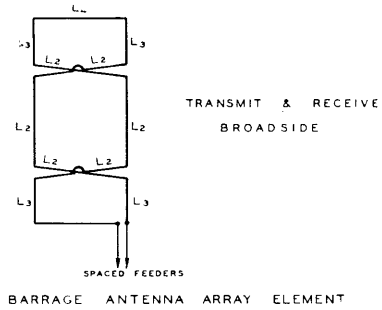

Fig. 59

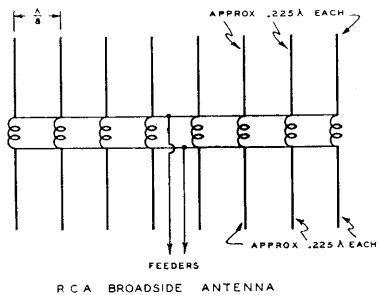

Fig. 60

sections are kept in phase by means of shunt inductances.

The waves are vertically polarized and the beam is broadside to the antenna. A reflector system spaced a quarter wave behind the antenna can be used to make it unidirectional.

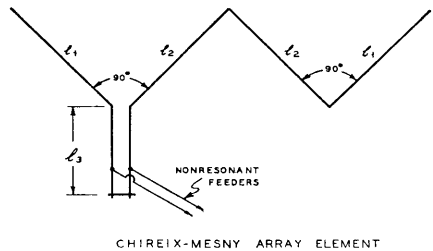

Fig. 61

Chireix-Mesny Antenna

● Numerous elements of the type shown in Fig. 61 are connected to form an antenna and reflector curtain for operation in many French commercial stations. In this case, the feeder system is different from that shown.

"V" Antennas

For amateur application a Zepp. type feeder is recommended. The dimensions for L_1 and L_2 are approximately a half wave in length, and for the amateur bands the lengths can be found in the Table of *Antenna Array Dimensions*.

"V" Antennas

● The horizontal "V" antenna shown in Fig. 62 is suitable for amateur as well as commercial work. The long wires L can be made several waves in length in order to obtain good directivity.

By choosing the proper angle δ , the lobes of radiation from the two long wire antennas aid each other to form a bi-directional beam. The back end radiation can be re-directed forward by a reflecting antenna similar to the radiating antenna, located an odd number of quarter wavelengths behind, and faced so that the two antennas are supplied with current 90° out of phase. Each wire L by itself would have a radiation pattern similar to that shown for antennas operated at harmonics; refer back to Fig. 11. Design data for the 10, 20 and 40 meter bands is listed in the Table, together with the proper angle δ .

This type of antenna can be made into a Vertical "V" as shown in Fig. 63, which is particularly adaptable for receiving, because only one antenna mast is required.

The angle δ for different lengths of L is shown in the chart for *Diamond Antennas*. A good ground connection is necessary.

Horizontal V antennas are easily constructed and have proven very effective. For

amateur operation L can be two or four wavelengths long. Commercial antennas are usually made eight waves in length in order to secure a sharper beam with a correspondingly greater power gain.

Diamond Antennas

● A very effective directional antenna having a low angle of radiation of horizontally polarized waves is shown in Fig. 64A. This non-resonant *Diamond* antenna consists of

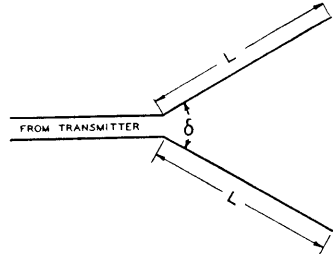

Fig. 62

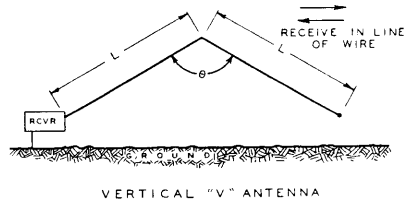

Fig. 63

"V" Antenna Design Table

Frequency in Kilocycles	"Half Wave" Dipole	"Full Wave"	$L = \lambda$ $\delta = 104^\circ$	$L = 2\lambda$ $\delta = 75^\circ$	$L = 4\lambda$ $\delta = 52^\circ$	$L = 8\lambda$ $\delta = 39^\circ$
		$L = \frac{\lambda}{2}$ $\delta = 180^\circ$				
28000	16' 8"	17' 1"	34' 8"	69' 8"	140'	280'
28500	16' 4"	16' 9"	34' 1"	68' 6"	137' 6"	275'
29000	16' 1"	16' 6"	33' 6"	67' 3"	135'	271'
29500	15' 8"	16' 2"	33'	66' 2"	133'	266'
30000	15' 6½"	15' 11"	32' 5"	65'	131'	262'
14050	33' 4"	34'	69'	139'	279'	558'
14150	33' 1"	33' 10"	68' 6"	138'	277'	555'
14250	32' 10"	33' 7"	68' 2"	137'	275'	552'
14350	32' 8"	33' 5"	67' 7"	136'	273'	548'
7020	66' 7"	68' 2"	138' 2"	278'	558'	1120'
7100	65' 9"	67' 4"	136' 8"	275'	552'	1106'
7200	64' 11"	66' 5"	134' 10"	271'	545'	1090'
7280	64'	65' 8"	133' 4"	268'	538'	1078'

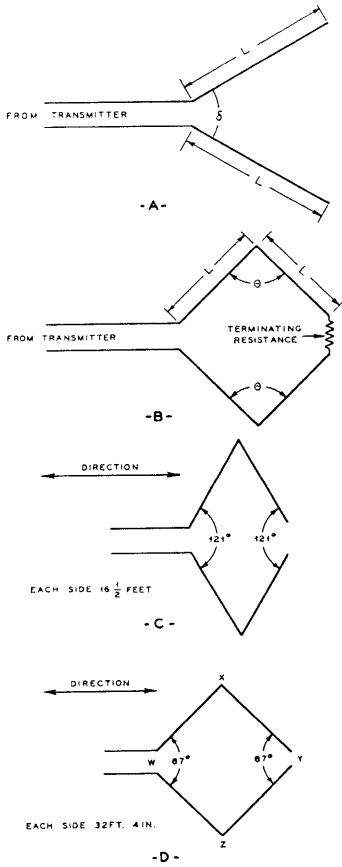

Fig. 64
Diamond and "V" Antennas.

two "V" antennas. The current distribution dies away uniformly from the input corner to the terminating resistance. As a result of this behavior, the Diamond antenna is not critical with respect to frequency. It can be used without any change or adjustment over a frequency range of at least two-to-one. Furthermore, it is unidirectional, since the terminating resistance eliminates the radiation which would otherwise take place in the backward direction. These properties make the Diamond antenna desirable in many ways. It can, for example, be used for 20 meters in the daytime and 40 meters at night, without any change. The terminating resistance should be about 800 ohms, capable of dissipating half of the power supplied by the transmitter. The antenna offers a resistance load of about 800 ohms to the transmission line. Design data is shown in the *Diamond Antenna Charts*

and the dimensions L are listed in the Table for "V" Antenna Design.

"V" Antenna Design

If the terminating resistance is not used, the Diamond antenna is bi-directional and becomes of the resonant type. Diamond antennas will radiate in an exactly horizontal direction, provided the angle of radi-

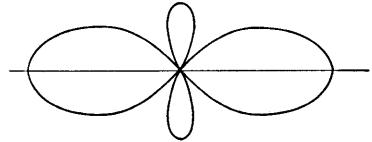

HORIZONTAL DIRECTIVITY OF A "V" ANTENNA
1 λ LONG ON EACH SIDE

Fig. 65

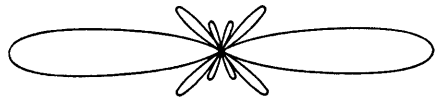

HORIZONTAL DIRECTIVITY OF A "V" ANTENNA
8 λ LONG ON EACH SIDE

Fig. 66

tion in degrees and the height of the antenna in wavelengths is correctly calculated. These calculations have been simplified, and the Chart will enable the quick determination of the necessary dimensions. For example, slanting the antenna 6° will cause the energy to be radiated in an exactly horizontal plane.

The Diamond antenna is much more economical in construction than the various forms of antenna arrays employing vertical curtains of wires. It is just as effective in its directivity and power gain, and is not critical with respect to frequency of operation.

Beverage Antenna

- A very long wire terminated in a resistance equal to its characteristic impedance is called a *Beverage*, or *Wave Antenna*, Fig. 71.

The antenna should be several wavelengths long and it can be of any convenient height, from 10 to 20 feet above earth. It is quite satisfactory for long-wave reception and is sufficiently directive to materially reduce static disturbances. It is non-resonant and can be considered as a one-wire transmission line with ground return. It should be pointed toward the station whose signals

Diamond and "V" Antennas

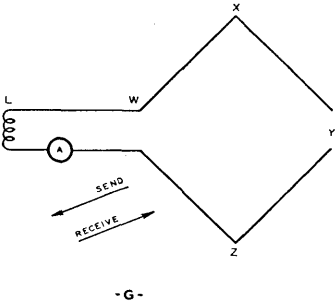
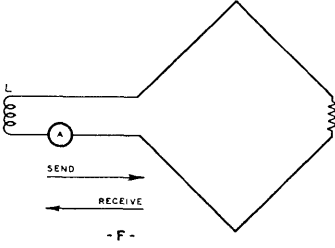
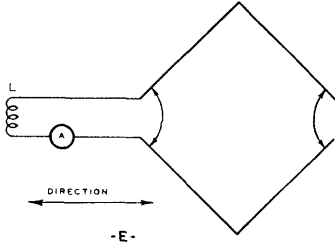

Fig. 67
Diamond Antennas.

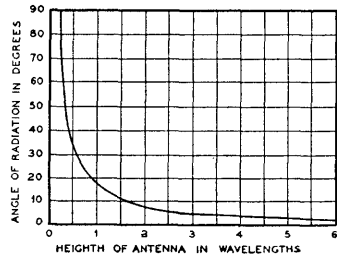
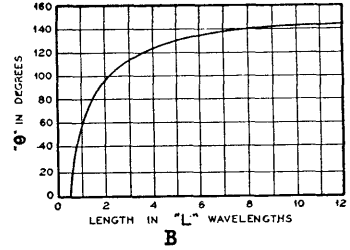
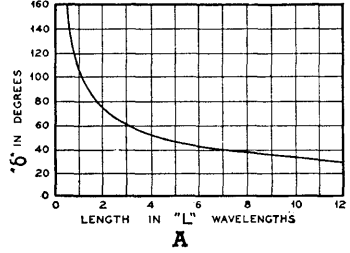
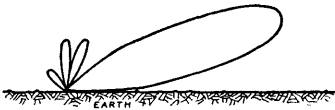

Fig. 68
Diamond and "V" Antenna Design
Curves.



VERTICAL DIRECTIVITY OF A 2λ DIAMOND ANTENNA

Fig. 69



HORIZONTAL DIRECTIVITY OF A 2λ DIAMOND ANTENNA

Fig. 70

are to be received. This antenna operates most effectively when located over poorly conducting earth, since in this case the wave front of the received signal is tilted more than when the wave travels over water or moist earth. This form of Beverage Antenna is not suitable for short-wave reception.

Antenna Coupling Methods

● It is obvious that the power from a transmitter must be transferred or coupled to an antenna in some manner; likewise, the received energy must be coupled into a receiver. There are a great many ways in which this transfer of energy can be accomplished. In some forms, the coupling

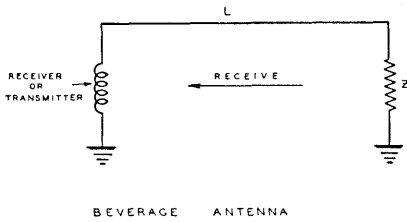

Fig. 71

device serves the dual purpose of transferring power and tuning the antenna to resonance; in other cases it prevents illegal radiation of harmonics. The impedance match for a final amplifier is accomplished in the coupler circuits which connect to the antenna or feeders. Impedances are matched when the plate current of the final amplifier is at its normal value when all circuits are tuned to exact resonance. When the plate current is below normal it is an indication that the antenna feeder impedance has been transformed into a too-high value, and vice-versa when excessive plate current is drawn by the final amplifier.

Types of Coupling Devices

● The simplest coupling method for a single wire fed or end fed antenna is by means of *Direct Coupling*, wherein the impedance matching is accomplished by tapping to the final amplifier plate coil, as in Fig. 72A.

A blocking condenser (.002 mfd.) should be connected in series with the antenna or feeder to prevent DC plate voltage from reaching the antenna and thereby endangering human life. The final amplifier plate coil has a voltage node either at the center or at one end, depending upon the type of amplifier used. The voltage node occurs at the center of the coil in a push-pull amplifier, and also in a plate neutralized amplifier. This voltage node (zero RF voltage) occurs at the lower end of the coil, both in the case of single-ended screen-grid amplifiers and grid neutralized single-ended amplifiers. The antenna or feeder tap is usually connected near the voltage node. The proper impedance match (normal plate current load) is obtained when the tap is at the proper point on the coil. If the tap is too close to the voltage node, the antenna will not sufficiently load the amplifier; if the tap is too far toward the plate end of the coil, excessive loading will result, with consequent overheating of the amplifier tube and lower efficiency.

Comparative RF Feeder Losses

Frequency	D. B. loss per 100 ft.	Type of Line
7 mc.	0.9	150 ohm impedance, rubber insulated twisted pair with outer covering of braid.
14 mc.	1.5	
30 mc.	3	
7 mc.	0.4	W. E. 3/8" concentric pipe feeder with inner wire on bead spacers. Impedance = 70 ohms.
30 mc.	0.9	
7 mc.	0.05	Open 2-wire line No. 10 wire. Impedance = 440 ohms.
30 mc.	0.12	
7 mc.	3	Twisted No. 14 solid weather proof wire, weathered for six months (telephone wire).
14 mc.	4-1/2	
30 mc.	8	

Inductive Coupling

● Energy can be supplied to the antenna or feeder from the final amplifier by means of induction between two coils. The antenna

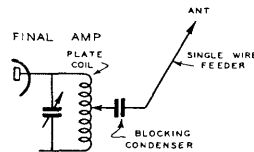

Fig. 72-A

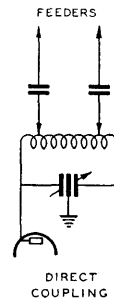

Fig. 72-B

coil can be tuned or untuned, as shown for several circuits in Figs. 34, 36, 40, 46 and 73.

Zepp. feeders sometimes use a split antenna coil which couples to each end of the final tank coil. A somewhat better system is to link-couple the Zepp. feeder tuning coil to the final amplifier coil because there is less capacity coupling and the coil losses are lower. 160 meter Marconi antennas can be coupled inductively to the final amplifier plate coil by means of some of the arrangements previously illustrated. The antenna should be tuned to resonance with series or parallel tuning and occasionally by adjustment of the tapped antenna loading coil. A suitable value of series condenser would be from .00025 mfd. to .0005 mfd. maximum capacity. The spacing between plates will

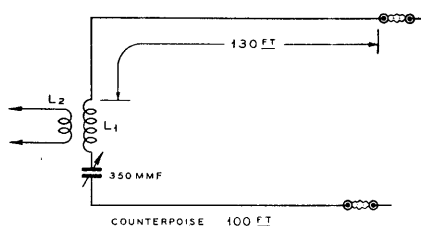

Fig. 73
L2—Final Plate Coil.

depend upon the power output of the transmitter and the RF voltage gradient at the point where the condenser is located. In most cases, plate spacing of .03-to-.07-inch will suffice. Resonance is obtained by switching taps and varying the condenser until the antenna loads the final stage plate current to its normal value. If this value is more or less than the rating for the tube, the coupling between the loading coil and the final tank coil should be increased or decreased.

Single wire fed, and end fed antennas can be tapped across part or whole of a tuned circuit which in turn is inductively or link coupled to the final amplifier tank circuit. The advantage of having an additional tuned circuit for the antenna coupler is in the reduction of harmonic radiation. A better balance can be obtained in the case of push-pull amplifiers than with direct coupling. More detailed information on coupling single wire antennas is given in preceding pages.

Twisted-pair feeders can be inductively coupled to the final tank circuit by using from one to four turns of well-insulated wire, wound over the voltage node of the final tank coil. The number of turns depends upon the frequency of operation and the desired antenna load.

Collins Pi Coupler

● This system consists of one or two coils and two variable condensers connected in the form of a low-pass pi filter. See Figs. 74 to 80. The filter permits the passage of only the fundamental frequency and greatly attenuates the undesirable harmonics, similar to the action of a filter used in AC power supplies. The coupler is tuned to the frequency of the transmitter by varying condensers $C1$ and $C2$, also by adjusting the taps on the coil or coils. The impedance of the antenna feeders is matched to the final amplifier by means of the ratio of the capacity of $C1$ and $C2$, and by adjustment of the coupler taps across the final amplifier tank coil.

This system can be used with some Zepp feeders, single wire or two wire feeders, and end fed antennas.

The plate tank of the final amplifier must be tuned to resonance with the pi network disconnected from it. It is best to do this with reduced plate voltage, and resonance is indicated by greatest dip in the plate current milliammeter reading. The final amplifier must not be retuned thereafter. Then connect the pi network to the final amplifier and antenna. Tune the two variable con-

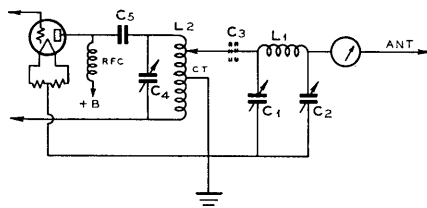

Fig. 74
Single-Wire Feed Line—Single Section Plate Tuning Condenser—Shunt Feed. $C1$ and $C2$ in All Circuits Are .00035 mfd.

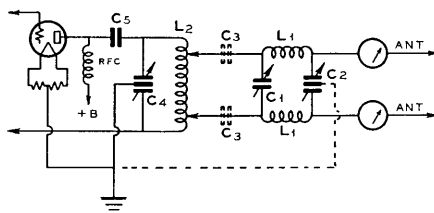

Fig. 75
Two-Wire Feed Line from Single-Ended Amplifier—Split-Stator Plate Tuning and Optional Split-Stator Used as $C2$. Shunt Feed.

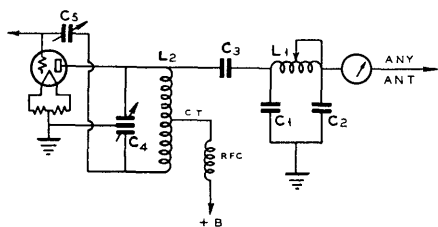

Fig. 76

Single-Wire Feed from End of Low Impedance Output Tube Tank. Split-Stator Tuning and Series Feed. C1 and C2 Should Be Variable.

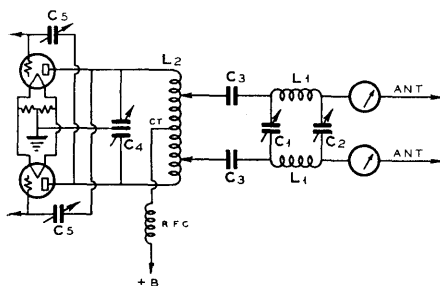

Fig. 79

Coupling a Two-Wire Line to a Push-Pull Final Amplifier. Single-Wire Line Out of a Push-Pull Final Through a PI Network is Not Recommended.

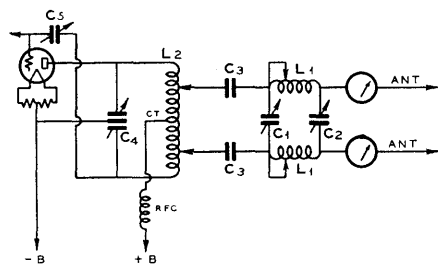

Fig. 77

Two-Wire Line from Single-Ended Amplifier. Split-Stator Tuning and Series Feed.

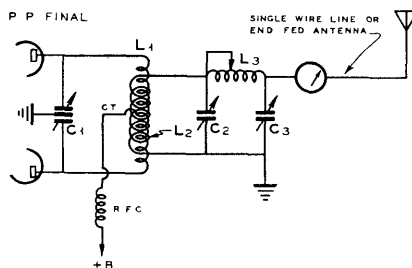

Fig. 80

Coupling a Single Wire Antenna or Feed-Line to a Push-Pull Final Amplifier.

L1 and L2 should be interwound in order to load both tubes equally in a push-pull amplifier. L2— $\frac{1}{3}$ Tank Turns, interwound or otherwise very closely coupled.

L3—Standard Collins coil.

C2-C3—.00035 mfd. each.

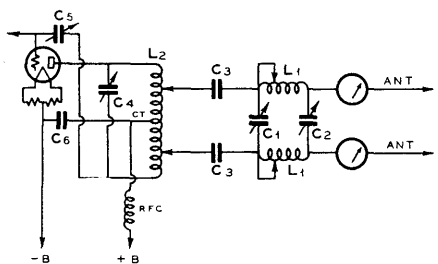

Fig. 78

Same as Fig. 77, But with Single-Section Tuning Condenser.

condensers in the pi network until maximum antenna current (or feeder current) is obtained at normal values of final amplifier plate current when normal plate voltage is applied. The pi network condenser which is closest to the final amplifier is used to obtain resonance in the network for any particular setting of the impedance matching condenser (the nearest one to the antenna). The amount of inductance in the network coils must be determined by experiment to obtain best results.

Link Coupling

● A tuned feeder circuit can be coupled to the final amplifier tank by means of a twisted or parallel pair of wires, with one or more loops of wire at each end, as shown in Fig. 81. These *link coupled* loops should be wound over the voltage nodes of the two tuned circuits. Variation of coupling can be accomplished by varying the number of loops, or the diameter of the loops with respect to the coil diameters. The number of coupling turns depends upon the ratio of impedances; in the case of a Zepp. antenna more coupling turns are needed around the antenna coil than around the plate amplifier coil. In nearly all cases

Link Coupling Methods

one to two turns around the plate tank coil will suffice. The number of turns around the antenna coil will vary from 1 to 4, or 5, depending upon the circuit used, i.e., parallel-tuned or series-tuned.

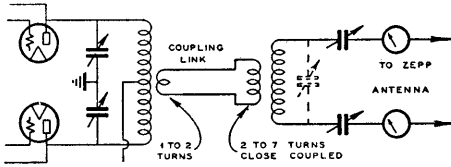

Fig. 81

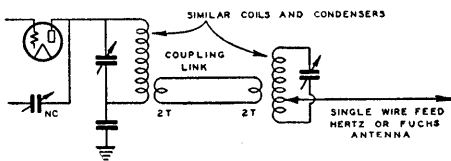

Fig. 82

Link Coupling for End-Fed or Single Wire Feeders.

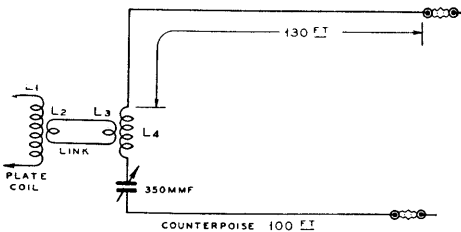
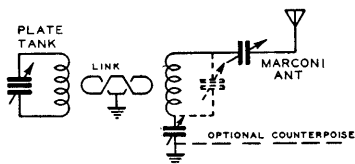

Fig. 83

Link Coupling to 160 Meter Antenna System.



FOR 160 METER OPERATION

Fig. 84

Adjustment of the coupling link and location of antenna taps on the antenna coil can readily be made with the aid of a field strength meter in order to find the adjustment which will provide maximum antenna field strength for normal load on the final

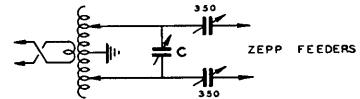
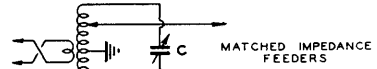
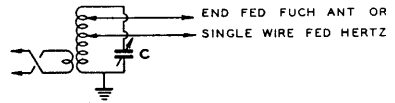

C = 50MMFD - 6500V

Fig. 84-A

Link Coupling from Final Amplifier to Tuned Antenna Circuits.

amplifier. When Zepp. feeders are used, RF meters can be connected in series with the feeders as an aid in tuning.

No. 14 or No. 12 rubber-covered solid wire is suitable for the coupling line. The coupling loops should have sufficient insulation to withstand the plate voltage.

Broadcast Type Antennas

● Older types of "T" and "Inverted L" flat-top antennas are rapidly being replaced with vertical antennas for broadcast transmission. The newer forms confine most of the radiation to very low angles, with the result that fading effects within a radius of 100 miles can be greatly reduced. The L and T type antennas provide some high angle radiation and the reflected waves from the Heaviside Layer cause fading effect at night within a radius of less than 50 miles. Reduction of sky wave radiation greatly improves the coverage of a broadcast station.

Vertical antennas are sometimes constructed by running a heavy wire conductor through the center of a lattice-work tower; in a great many cases the metal tower itself is the radiator. The base of the antenna usually connects to a tuning device and then to a very extensive ground system. The tuning device also serves to terminate the transmission line, such as shown in the examples given for *Concentric Lines*. The vertical antennas in Fig. 85 have a current distribution as shown, which indicates the relative values of impedance with respect to ground. These antennas connect to ground through tuned circuits and conse-

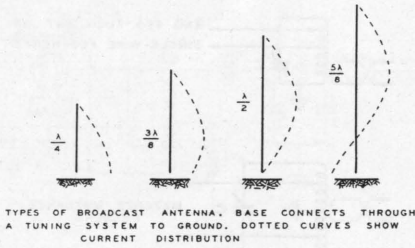

Fig. 85

quently they are resonant to the frequency of the transmitter. Antennas more than one quarter wave in vertical height provide a better low angle wave (ground wave); because of their greater effective height they are being used in the newer broadcast station installations.

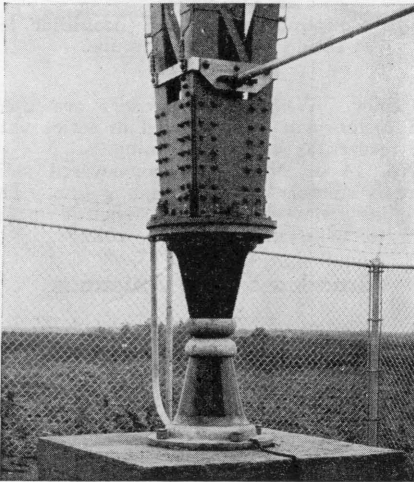

Fig. 86
Base of Vertical Radiator With Heavy Insulator Supports

Two Band Tilt Antenna

● A simple bi-directional antenna for 10 meter operation, and a non-directional 20 meter antenna, is shown in Fig. 87.

This antenna consists of a 33 foot length of $\frac{3}{4}$ -inch diameter *Dural* tube, supported on a large stand-off insulator in such a manner that the angle of tilt can be adjusted and the free end swung through an angle of approximately 180 degrees. The antenna is used in a vertical position for 20 meter operation; for 10 meters it is tilted to an angle of 54 degrees with respect to

the horizon, and pointed toward or away from the direction in which it is desired to transmit or receive. The angle of radiation is in a horizontal plane for both 10 and 20 meter operation. A single wire feeder can be connected to the pipe at a point eleven feet up from the bottom end, or a Zepp, or end-fed connection can be employed. The

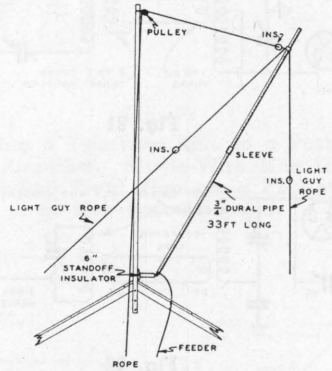

TWO BAND (10-20 METER) TILT ANTENNA —
VERTICAL FOR 20 METERS — TILT 54° FROM HORIZON
FOR 10 METERS

Fig. 87

pipe should be guyed near the center by means of heavy cord or light rope in order to facilitate the rotation of the radiator. A 33 foot pipe can be made from two sections, butted together over a smaller inner tube, or outer sleeve, for a forced-fit connection.

Dummy Antennas

● A non-radiating antenna is essential for experimental tests of any transmitter. The name "*Dummy Antenna*" has been applied to such arrangements. It consists of a resistive load which simulates the regular antenna load. The resistors in the dummy antenna must be large enough to dissipate the RF power output delivered by the transmitter. Non-inductive resistors made for this purpose can be connected in series with thermo-ammeters to determine RF power output. Mazda Lamps provide a visual indication of RF power output because this power is converted into light in the same manner as illumination is secured from the 110-volt line. The dummy antenna circuits shown in Figs. 88, 89 and 90 are suitable for all practical purposes.

A 100 watt Mazda Lamp when lighted to normal brilliancy in a dummy circuit indicates that the transmitter is delivering 100 watts of RF output. The resistance of electric lamp bulbs varies widely with filament temperature, therefore it is difficult to

Field Strength Measuring Sets

accurately determine the power output of the transmitter by Ohm's $I^2 R$ Law, because R is a variable factor.

Field Strength Measuring Set

● Actual RF current readings in any portion of an antenna vary with the position of the current nodes, with the result that an antenna may not be correctly tuned to the operating frequency of the transmitter. An actual indication of the power radiated by an antenna can be secured with the aid of a field strength measuring set, which consists of a low-reading milliammeter, diode rectifier and tuned circuit or pick-up coil. A circuit diagram for an effective field strength measuring set and phone monitor is shown in Fig. 91.

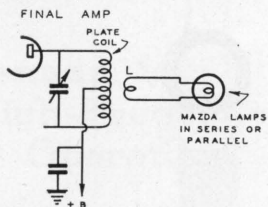

Fig. 88

Mazda Lamp Coupled to Final Tank Coil.

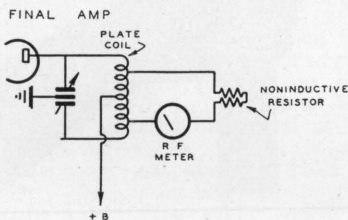

Fig. 89

Dummy Antenna with Non-Inductive Resistor and R-F Meter.

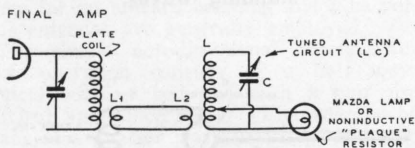
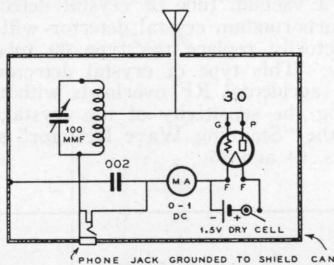

Fig. 90

Dummy Antenna Link Coupled to Plate Coil. L_1 - L_2 Are Wound Over the Plate Coil and Antenna Coil, L .

When the headphones are plugged into the phone jack, the presence of key clicks,

excessive carrier hum or quality of voice modulation can be determined. By plugging a 10,000 ohm resistor into the phone jack, the milliammeter will indicate overmodulation peaks as shown by a fluctuation of the steady carrier strength when voice modulation is applied. Furthermore, this field strength meter can be used as a neutralizing indicator by merely connecting a short pick-up antenna wire to the device and placing it near the circuit which is to be neutralized.



FIELD STRENGTH MEASURING SET & PHONE MONITOR

Fig. 91

Simple Circuit of Field Strength Meter.

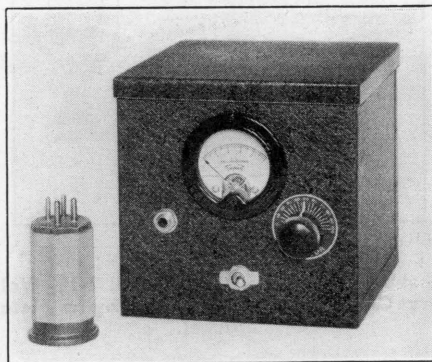

Fig. 92

Exterior View of Field Strength Meter and 40-80 Meter Coil.

Plug-in meters are tuned to the frequency of the transmitter. The pick-up antenna wire which is connected to the field strength measuring set is placed somewhere in the immediate vicinity of the radiating portion of the antenna. The length of the wire and its distance from the transmitting antenna depend upon the power output of the transmitter. The pick-up antenna can be from five to six feet long, depending upon the frequency and the amount of pick-up required to secure a deflection of the meter. The antenna system is tuned for maximum

reading on the milliammeter scale, which denotes the greatest amount of field radiated by the antenna.

A type 30 tube is connected as a diode, which will operate satisfactorily with only 1½ volts of filament battery. The diode is connected across a portion of the tuned circuit, which results in more selective tuning and good sensitivity. The 0-1ma. DC milliammeter reads the rectified current produced by the RF energy in the tuned circuit. The diode serves as the rectifier, which can be either a vacuum tube or crystal detector.

A carborundum crystal detector will quite satisfactorily replace the type 30 tube and battery. This type of crystal detector will handle accidental RF overloads without destroying the sensitivity of the crystal, such as in the "Standing Wave Detector" shown in Figs. 94 and 95.

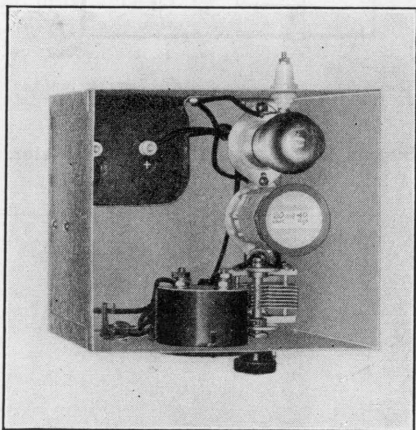

Fig. 93

Looking Into the Set. A Small 1-1½ Volt Dry Cell Is Held in Position by a Metal Bracket.

The coils are wound on plug-in forms, 1½-inch diameter, three coils being required to cover the six amateur bands from 5 to 160 meters. The 5 to 10 meter coil has two turns, spaced ½ in. apart, with a tap at the center. The 20 and 40 meter coil has 12 turns, space-wound to cover a winding length of ¾ in., with a tap taken on the fourth turn from the ground end. For 80 and 160 meters, 60 turns are close wound on the form with a tap taken on the 20th turn from the bottom end of the winding. A midget 100 mmfd. variable condenser will tune the coils in such a manner that the lower values of capacity will cover one end of the band and the higher capacity will cover the other; a single coil thus covers two bands.

The field strength meter should be housed in a completely enclosed metal can.

Grounds

● A good connection to earth is essential for operation of Marconi antennas for both receiving and transmitting. Several pipes driven into the earth, spaced a few feet apart and connected together, will provide a good ground system for amateur operation. Broadcast and commercial transmit-

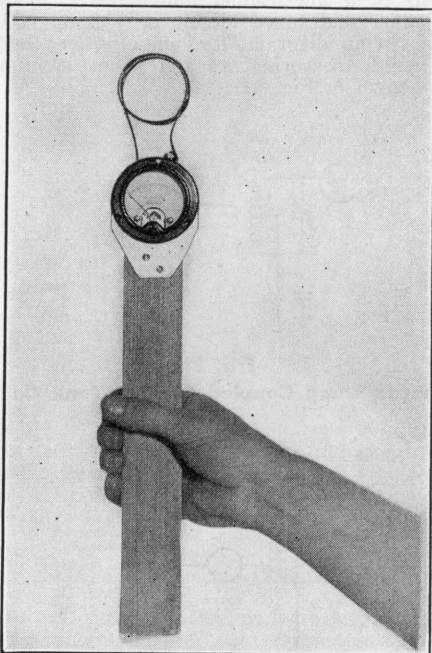
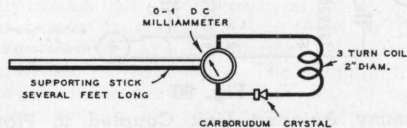

Fig. 94

"Standing Wave Detector" and Field Strength Meter. The Device Is Moved Along the Feeder or Antenna, held close to the wire. A variation of current denotes standing waves.



SIMPLE R F FEEDER MEASURING SET

Fig. 95

Simple Circuit Diagram of Device Illustrated in Fig. 94.

ters often require a very elaborate ground system of several miles of copper wire or ribbon, buried under the surface of the earth. Such a system can be constructed so that it fans-out in all directions beneath the antenna. Ordinary water pipes are generally suitable for receiver ground connections.

When a satisfactory ground connection is not available, a *Counterpoise* must be used with Marconi antennas. The radiation resistance of a quarter wave antenna is approximately 37 ohms, therefore the ground resistance must be considerably less than 37 ohms in order that the greatest amount of transmitter power will be radiated into space. A high resistance ground connection can waste more power than is actually radiated by the antenna. This is one reason why half wave antennas are so widely used; they require no ground connection.

Antennas for Ultra-High-Frequency Operation

● The fundamental principles of antennas for wavelengths below 10 meters are no different than those discussed elsewhere for short-wave operation. The physical size of these antennas is such that they are economical to construct and they can easily be made portable. In the ultra-high-frequency field of communication the direct, or ground wave is used; for this reason the transmitting and receiving antennas are generally in visual range of each other. It is therefore necessary that the antennas be located as high above ground as possible. Low angle radiation is necessary and antennas which are particularly effective for this purpose should always be used. The earth reflects the ground wave upward, somewhat like the effect which is created by a body of salt water which pushes the somewhat longer wave in an upward direction. The ground acts like a mirror in reflecting light waves. Vertically polarized waves have less tendency for an upward bending, and thus vertical antennas are generally employed.

The simple non-directional antenna for u.h.f. operation consists of a half wave vertical wire or rod, fed with a two-wire matched impedance feeder (Fig. 98), or by means of a quarter wave matching stub and two-wire non-resonant line, Figs. 96 and 99.

Zepp. feeders are seldom employed, because the antenna in most cases is located several wavelengths away from the transmitter or receiver in order to secure ample height above the ground.

A *Concentric Feeder* (Fig. 100) is very effective for feeding either a half wave an-

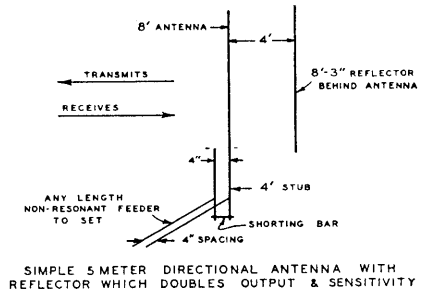

Fig. 96

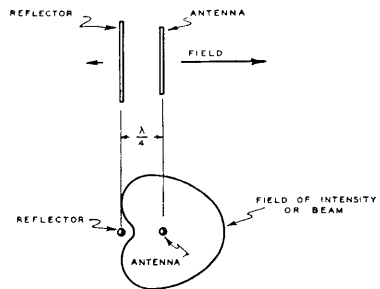

Fig. 97

Directivity Pattern of Antenna Shown in Fig. 96.

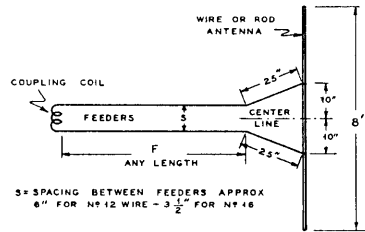

Fig. 98

5-Meter Matched Impedance Antenna.

tenna or a quarter wave Marconi antenna, such as those used for mobile 5-meter work.

Directive antennas often prove of great value in the ultra-high-frequency region because the high power gain which is obtainable gives the same result as a great increase in transmitter power. The cost of increasing power is far more than that of a simple antenna array. Any of the directional antenna systems previously discussed can be used for u.h.f. communication, although those

which give vertical polarization, such as the Stacked Dipole, Yagi, Vertical Franklin, or Bruce are best.

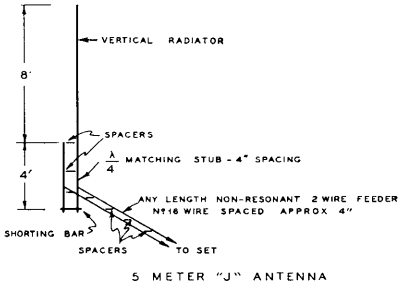
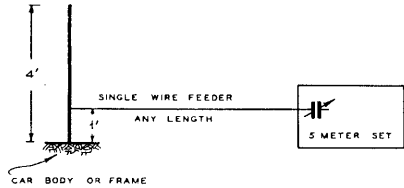

Fig. 99

twisted pair to some particular length. This can best be determined by experiment, because a few inches more or less of feeder will provide a tuning effect and allow more efficient operation.

Quarter wave rods can be mounted on the roof of an automobile, if some means of flexible coupling is built into the base of the rod so that the antenna can be swung down



SIMPLE 5 METER AUTO ANTENNA

Fig. 102

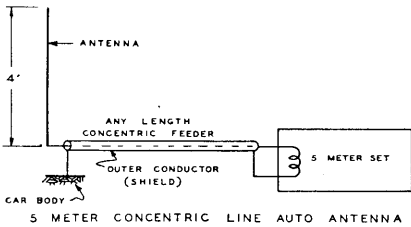

Fig. 100

when it strikes an overhead obstacle, such as a garage entrance, etc. Sometimes the rod is mounted on the front or rear bumper of the car, on the radiator, running board or fender. In many cases the antenna rod is mounted directly on a transmitter housed in the rear trunk of the automobile.

Mobile antenna installations for police radio work differ from the 5-meter types in that the antennas are somewhat longer because the frequency of operation is lower. The length can be calculated from the formula:

$$L_1 = \frac{492,000 \times 0.485}{f}$$

where L_1 = The quarter wave antenna length in feet.

f = The transmitter frequency in kilocycles.

The length of a half wave antenna is twice that of a quarter wave antenna.

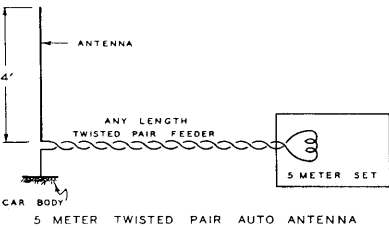

Fig. 101

Types of Mobile U. H. F. Antennas

● A quarter wave vertical Marconi antenna (Fig. 102) is very convenient for automobile installations. A 4-foot rod with the bottom end grounded to the car body can be fed with a single wire feeder several feet long; this feeder connects to the 5-meter set in the car.

Another 5-meter antenna consists of an insulated 4-foot rod, fed by either a twisted pair (solid conductors), or by a concentric transmission line, Figs. 100 and 101. In the case of twisted pair feeders, the impedance match is not very good, but this effect can be overcome to some extent by cutting the

Fixed Station 5-Meter Antennas

● These antennas can be constructed from copper or aluminum rod, or wire. When a wire antenna is used, the wire can be supported on stand-off insulators attached to a vertical 2"x3" wood pole. The pole should be guyed, preferably with ropes, in order to keep metallic conductors away from the field of the antenna. The antenna should be as high as possible and well remote from surrounding objects.

These same types of antennas can be used for television reception by making the half wave antenna resonant to the frequency of the television transmitter. In this case a

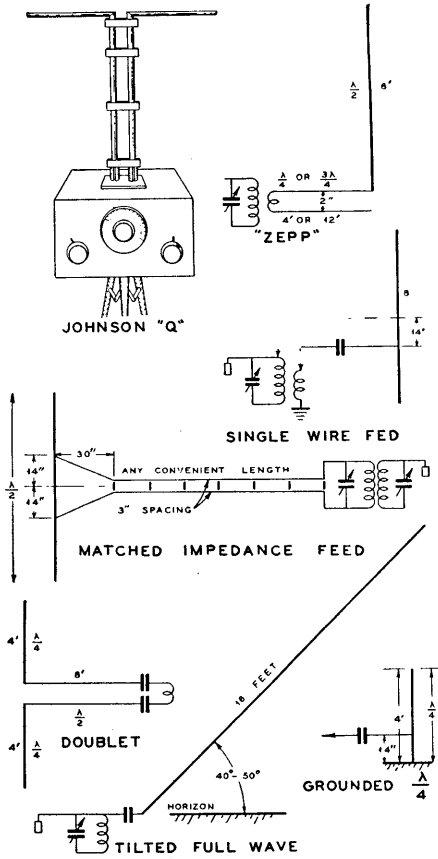

twisted-pair feeder of solid wire, such as the *EOI Cable*, can be used in order to reduce automobile ignition interference. The loss in a twisted-pair feeder at these frequencies is rather high and transposition blocks can be used at intervals along the two-wire feeder line.

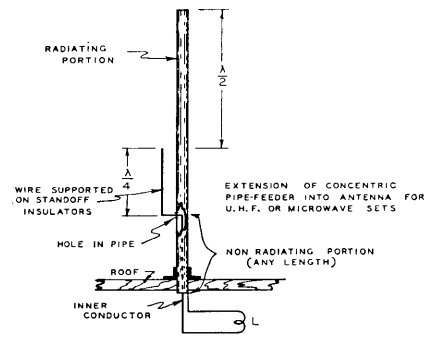

Fig. 103

Long wire antennas can be used on 5 meters providing the directional effects are taken into consideration. For example, a 20 or 40 meter single wire fed or Zepp. antenna can be operated on 5 meters with fairly satisfactory results for both transmitting and receiving.

2 1/2-Meter Antennas

Any of the antennas previously described, and which provide vertical polarization, are suitable for 2 1/2 meter operation. Those shown in Fig. 104 are ideally suitable for use with a 2 1/2 meter transceiver. The figures are self-explanatory, in that all dimensions are clearly shown. The Table showing *Antenna Array Dimensions* lists all of the data for the ultra high-frequency bands, down to 1 1/4 meters. The Table, *Reflector and Director Dimensions*, shows the data for any form of Yagi or Parabolic Reflector system for wavelengths down to 1 1/4 meters.

Micro-Wave Antennas

Antennas for operation in the vicinity of one meter, or less, are classified as *Micro-Wave Antennas*. Half wave vertical rods are suitable for portable operation and in most cases they can be capacitively coupled at one end to the micro-wave transmitter or receiver. Directive arrays, especially those of the Yagi type, are easily constructed; they greatly improve the performance of micro-wave sets.

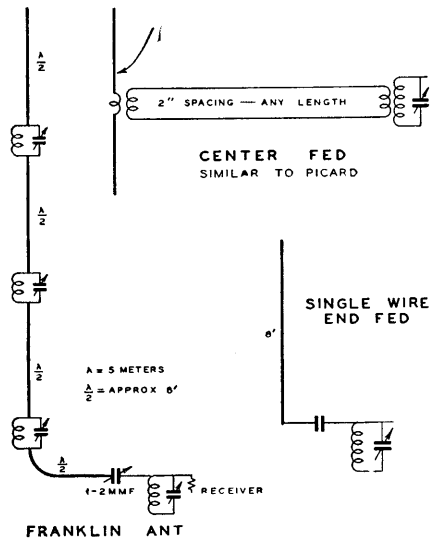

Group of Typical 5-Meter Antennas.

2½ METER TRANSCEIVER ANTENNA SYSTEMS

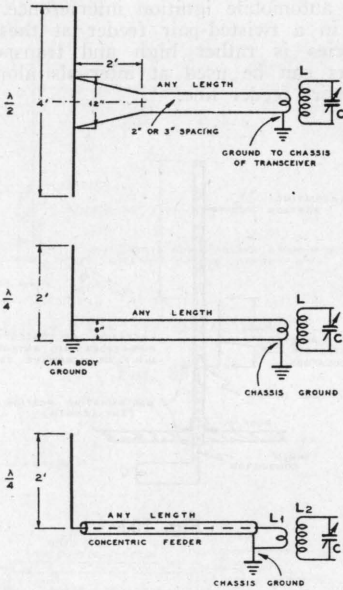

Fig. 104

Concentric Lines

● A concentric transmission line is one of the most satisfactory means for carrying RF power from the transmitter to the radiating antenna. It has low losses, is weather-proof and the outer conductor is at ground potential. No radiation can occur, which is particularly important in a directional antenna system. The characteristic impedance ranges from 50 to 150 ohms, depending upon the ratio of inside diameter of the outer conductor to the outside diameter of the inner conductor. Its impedance can be calculated from the formula:

$$Z = 138 \times \text{Log}_{10} \frac{D}{a}$$

where D is the inside diameter of the outside conductor,
 d is the outside diameter of the inner conductor.

The outer conductor can be grounded at any point. The inner conductor is insulated from the outer sheath by glass or isolantite beads which are placed at intervals along the line; the beads also furnish the necessary mechanical spacing.

Concentric line feeders are used for coupling broadcast transmitters to the antenna, as well as in short-wave and u.h.f. installations. See Figs. 105 to 108. The impedance can be made to exactly match the

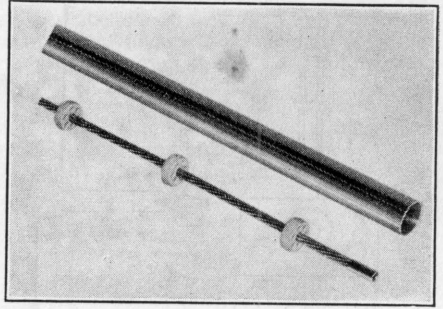

Fig. 105
Heintz & Kaufman Concentric Transmission Line.

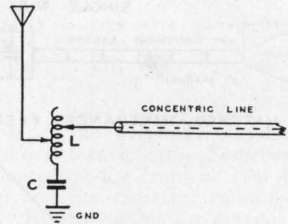

Fig. 106

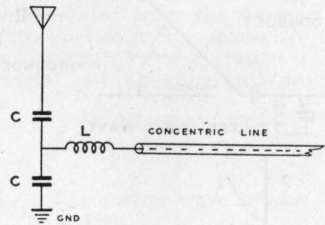

Fig. 107

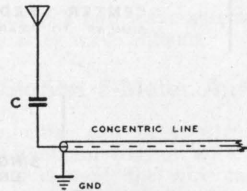

Fig. 108
Concentric Feeder Systems for Broadcast Antennas with Various Terminations.

center impedance of a half wave antenna, and very closely matched to a quarter wave antenna. A vertical quarter wave antenna has an approximate radiation resistance of 37 ohms at the current loop (ground connection).

Reinartz Rotary Beam Antenna

Concentric lines can be buried underground and run for distances of several hundred yards without sacrificing appreciable amounts of RF power.

Reinartz Rotary Beam Antenna

● The John L. Reinartz compact directive antenna, Figs. 109 and 111, has relatively high efficiency on the short and ultra-short wavelengths. It is suitable for 5-meter transmission and reception and its field pattern is similar to that of a half wave vertical antenna with single reflector, Fig. 110.

It consists of two 8-foot lengths of tubing, bent into a circle, with 2 in. to 3 in. spacing between the tubes. The circles are not closed; an opening of one inch remains, as shown in the diagram.

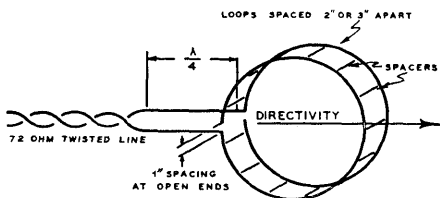
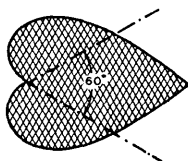

Fig. 109

Reinartz Rotary Beam with Twisted-Pair Feeder and Stub.



RADIATION PATTERN

Fig. 110

Directivity of the Reinartz Rotary Beam.

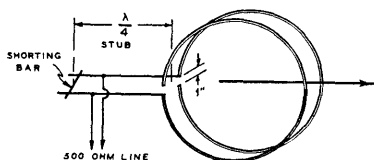

Fig. 111

Reinartz Rotary Beam Antenna with Spaced Feeder and Stub.

The diameter of the circle is a little over 30 inches. The most efficient method of feeder connection to a 5-meter set is by means of a quarter wave matching stub connected to either a twisted pair feeder or two wire 500 ohm line. This type of antenna

can be placed in either a horizontal or vertical plane, depending upon whether horizontal or vertical polarization is desired. The actual power gain over that of a vertical half wave antenna in the desired direction is approximately 15%. The power directivity is nearly 6-to-1 in a forward direction away from the open ends.

16½ ft. rods can be used for 10 meter operation, 33 ft. rods for 20 meters. The spacing between the rods, or circles, need not be increased when the antenna is built for operation on the longer wavelengths.

The antenna should be arranged for 360° rotation.

Antennas for Receiving

● All of the transmitter antennas previously described are suitable for receiving; their directive properties are unchanged. All-wave receivers present a difficult problem from the standpoint of a suitable antenna that will cover the wide frequency range of the receiver. Noise reduction is a decided factor in the design of an antenna for receiving all waves. The most prolific noise-creators are electrical devices, such as refrigerator units, violet-ray apparatus, thermostats, diathermy machines, battery chargers, electric signs, buzzers and doorbells, ignition systems of oil-burners and automobiles, elevators, street cars, electric motors, power-line disturbances which are carried along the line, telephone ringers, etc. These disturbances are of a radio nature; however, their intensity dies away rapidly in open space. House wiring and metallic structures convey these electrical disturbances, and noise reduction can therefore be accomplished by locating the antenna in a clear space, also by using a lead-in of such type that pick-up on the lead-in is practically eliminated. The noise interference is sometimes so loud that it will seriously interfere with local reception. It becomes a very troublesome factor in short-wave reception because the received signal strength is much lower than that from local broadcast stations.

Two general types of lead-ins are widely used with noise-reducing antenna systems. The shielded lead-in is effective in the broadcast range, but due to the high capacity between the shield and the lead-in conductor inside the shield, it is not often used for short-wave reception. For short-wave reception a balanced transposed line is more efficient, as shown in Fig. 112. Balanced lines consist of twisted-pair feeders or two-wire lines with transposition blocks. The latter can be tuned by means of a coil and variable condensers at the receiver in order to increase the signal energy for a compara-

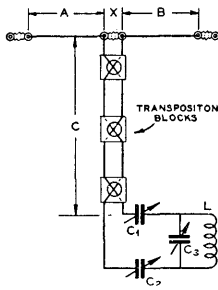

Fig. 112

Noise-Reducing Short-Wave Doublet Feeder System with Transposition Blocks.

A and B are 33 ft. each. C can be any length. The Transposition Blocks are spaced 2 feet apart. C1, C2 and C3 are 350 mmfd. Variable Condensers for tuning the system. L is the Receiver Coupling Coil.

tively wide range of frequencies. Twisted-pair feeders cannot be easily tuned because standing wave effects will cause excessive dielectric losses. In order to cover a wide range of frequencies with twisted-pair feeders, combination *Doublet* antennas are connected through impedance matching transformers to form an efficient all-wave antenna system. A single doublet with a twisted-pair feeder and without special transformers is suitable for operation over a very narrow band of only a few hundred kilocycles on the fundamental and third harmonic. The design of the feeder transformers depends upon the impedance of the twisted-pair feeder, length of line and type of doublet antennas connected to the line. So many complications enter into the design of these feeder transformers that the home constructor cannot easily build them. Complete short-wave antenna kits with all proper components are available from many sources. The choice of an all-wave antenna for the home constructor is the tuned transposed-feeder system, shown in Fig. 112. In noise-free locations, any single wire antenna will give good results.

RCA World-Wide Antenna System

● In this system a double-doublet is connected through a complicated antenna transformer to a twisted-pair transmission line, then through another transformer connected to the all-wave receiver. See Fig. 113.

The smaller doublet is about 33 feet long and it peaks at 14 megacycles. The larger doublet, 58 feet long, resonates near $7\frac{1}{2}$ megacycles and the third harmonic is 22 megacycles. The combination, together

with a critical length of feeder line, results in fairly uniform response from 6 to 24 megacycles. See Fig. 114. The twisted-pair feeder has an impedance of 180 ohms and is constructed with submarine cable rubber and paper insulation in order to keep the losses low. Noise reduction depends upon the design of the transformer which couples the line to the radio receiver. This transformer eliminates in-phase signals while at the same time it passed the out-of-phase signals. The expression "*in-phase*" means that the voltages of the two sides of the feeder line are positive or negative at the same instant. *Out-of-phase* signals are those which cause one side of the line to be negative while the other side is positive, and it is this signal which comes from the antenna. In-phase signals are those which are picked-up by the feeder line; they normally have a high ratio of noise signal to radio station signal.

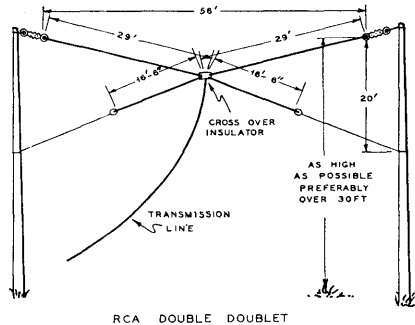

Fig. 113

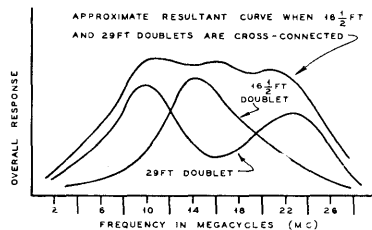

Fig. 114

The radio set transformer has a static shield between primary and secondary windings in order to eliminate capacity coupling. As a result, the in-phase signals and noise picked up by the line are eliminated, while the out of phase signals picked up by the antenna are passed through to the receiver. See Fig. 115.

Several windings are needed in each transformer in order to cover the wide frequency range. Automobile ignition noise is greatly reduced, as can be explained by referring to Fig. 115. "S" represents a

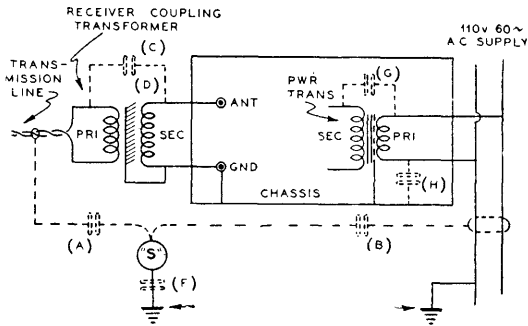

Fig. 115

source of auto ignition noise; (A) the capacity coupling from "S" to transmission line; (B) the capacity coupling from "S" to the power supply line; (H) the capacity coupling from one side of the power supply line to the metal chassis; (F) the capacity coupling from "S" to actual earth ground.

The noise voltage that would be induced by capacitive coupling (A) into the transmission line would correspond to an in-phase signal and would be fed to the secondary of the coupling transformer by the capacity by the electrostatic shield (D). This prevents noise voltage from being developed across the input terminals of the radio receiver.

The noise voltage that would be induced by capacitive coupling (B) causes current to flow through the power transformer and develop a noise from ground to chassis through capacity (H). If no receiver coupling transformer is used, this voltage would occur across the input terminals of the receiver and cause noise interference. Most power transformers have an electrostatic shield between the primary and secondary windings in order to minimize the capacitive coupling (G). 110 volt a-c supply lines often carry noise interference.

RCA Spiderweb Antenna

● The action of this antenna is like that of a "T-type" over the range from 140 to 4000 KC. Above 4000 KC the system automatically operates as an efficient multiple doublet up to 70,000 KC with good noise reduction between 4,000 and 70,000 KC. Half wave doublets operated near resonance are extremely efficient. See Fig. 116. Several doublets of different lengths can be connected to the same transmission line with-

out effecting the performance of any other, resulting in good signal pick-up in several bands of frequency. If the selected resonant frequencies are not too far apart, the overlapping of their characteristics will tend to give fairly uniform response. Five doublets are utilized in the RCA Spiderweb Antenna System.

In Fig. 116 the bottom wires E and F resonate to 6 MC (49 meters) by means of a small loading coil. A and B, at 12 MC (25 meters); C and D at 18 MC (16 meters); G and H at 35 MC (9 meters); K and L at 60 MC (5 meters). Loading coils are used in the G and H doublet, as well as in the E and F doublet.

The transmission line requires 75 feet of twisted-pair wire, although 45-ft. sections can be added if the 75-ft. length is not sufficient. These lengths must not be changed, because the receiver coupling transformer is matched to the line for these lengths. The transformer has a balanced primary and an electrostatic shield which prevents capaci-

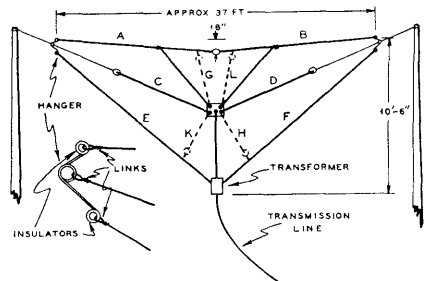

Fig. 116

RCA Spiderweb Antenna.

tive coupling. This is necessary for noise elimination. No noise reduction is secured for frequencies below 4,000 KC because the antenna acts as a T-type on the lower frequencies. The space required for this antenna is a span of 38 feet, and a 12 foot vertical clearance.

Philco All-Wave Antenna

● This doublet antenna is approximately 60 feet long and has a special antenna transformer connected to a twisted-pair feeder for all-wave reception from 540 KC to 23,000 KC. See Fig. 117.

A receiver impedance matching transformer is required for radio receivers which have a high impedance primary circuit. This transformer is not needed with radio receivers which have low impedance primary circuits designed for doublet antenna connection. The transformer is provided with

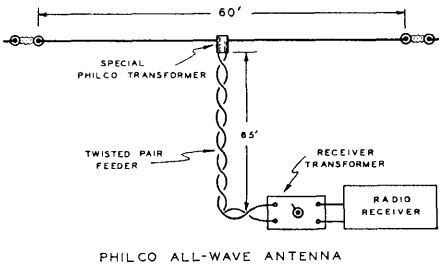

Fig. 117

a switch. The switch permits reception of standard broadcast or short-wave signals at will. The twisted-pair feeder can be altered in length to suit any installation without change in results. Noise reduction is claimed for both standard and short-wave reception.

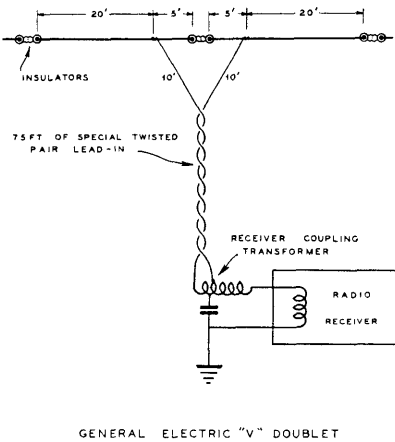

Fig. 118

General Electric "V" Doublet

● Another noise-reducing all-wave antenna is the *G. E. "V" Doublet*, consisting of a half wave doublet, matching section and twisted-pair feed line. It also incorporates an impedance matching transformer to the receiver, which is designed to cover a wide frequency range necessary for all-wave reception. This system has a "V" matching section at the center of the antenna instead of the usual complicated antenna-to-line transformer. Standing waves exist on the twisted-pair feeder, as is the case in almost every type of all-wave antenna. The arrangement shown in Fig. 118 provides good efficiency on broadcast and short-wave bands, a condition which is not possible with

a simple doublet where the twisted-pair feeder connects directly into the center of the antenna.

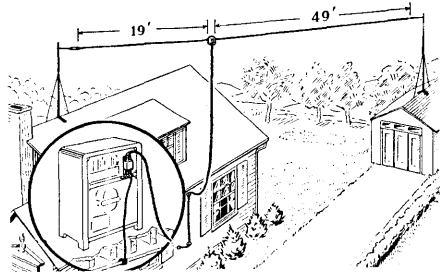

Fig. 119

RCA RK-40 Antenna

● The RCA RK-40 Antenna is a simplified antenna system designed to act as an efficient pick-up medium, giving high signal strength over an extremely wide frequency range. See Fig. 119. The flat top portion is 68 feet long, with an RCA transformer 19 feet from one end, as shown in Fig. 119.

The Transmission Line is a special two conductor cable 75 feet long, which terminates in a sealed junction box in which the receiver coupling unit is housed. This coupling unit matches the transmission line to the input receiver circuits. Adequate coverage of all short-and-long-wave broadcast bands is secured with a minimum of installation work.

Belden Off-Center Doublet

● To obtain a broad response over a wide frequency range, the Belden Off-Center Doublet Antenna System is constructed along scientific lines. The flat top portion

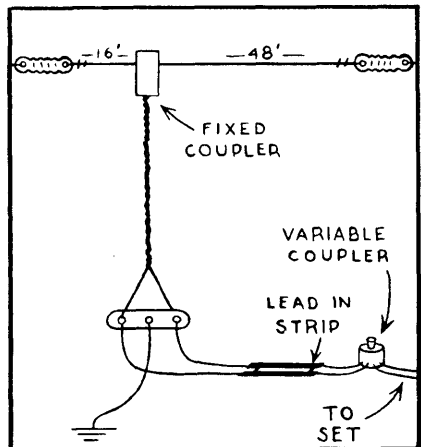

Fig. 129

Doublet and Auto Antennas

consists of two lengths, 16 and 48 feet respectively, of seven strand twisted No. 24 enameled aerial wire. See Fig. 129.

A fixed coupler in a weather-proof container is used to connect the twisted feeders to the flat top of the antenna. The surge impedance is of a value which spreads the responsive characteristics of the system. At the receiving end, a center-tapped coupling transformer is employed to divert unwanted in-phase signals picked up by the lead-in to the ground. The secondary of this coupler is in series with a small variable capacitor which may be adjusted to match the input impedance of the receiver to the lead-in. This antenna system may be erected vertically or horizontally. It has practically no directional effect and the length of the lead-in is not critical, due to the variable features of the receiver coupler. This antenna does not have a sharp resonant point and achieves a very uniform response over the short-wave and broadcast frequency bands.

The coupling transformers at the ends of the twisted lead-in also serve to minimize the effect of the capacity of the lead-in, preventing loss in signal strength and at the same time preserving the noise reducing features.

The Belden Receiver Coupler is equipped with a switch with which to convert the antenna system into a conventional Marconi modified "T" antenna for use on broadcast frequencies.

McMurdo Silver "R9+" Antenna

● This system consists of a doublet with two sections, each 25 feet long, feeding into a twisted-pair transmission line which, in turn, couples to a special all-wave transformer coupling system. See Fig. 120.

The 4-pole, 5-position switch effectively matches the antenna system into the receiver for all-band operation. The doublet antenna resonates at approximately 32 meters, but the feeder and the tuning unit effectively increases the signal strength at other frequencies.

Antennas for Automobiles

● The amount of available space in an automobile for antenna installation is limited, therefore a compact system with relatively low efficiency is all that can be expected. Earlier types of antennas for automobiles consisted of wire screen or mesh supported in the roof of the car. Later types make use of plate or rods, suspended under the car or beneath the running boards.

Experiments have proven that most of the ignition interference exists above 30 MC,

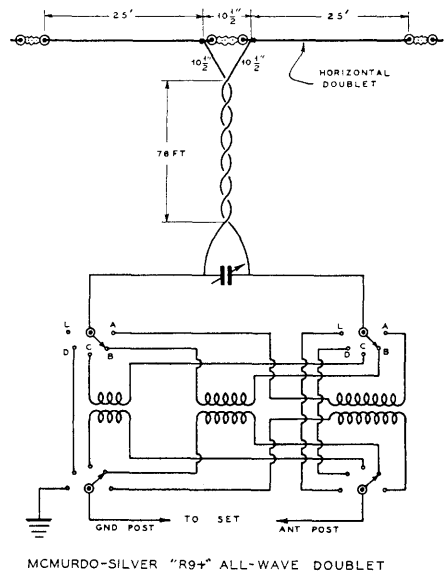

Fig. 120

yet the noise is troublesome even in the range of the broadcast band. The principal source of noise comes from the ignition system, and thus a shielded lead-in or shielded transmission line to the antenna will greatly reduce this interference. In some cases, out-of-phase electrical noise is deliberately introduced into the receiver in order to cancel the noise which is picked-up by the antenna. Modern design has practically eliminated the need for spark-plug suppressors.

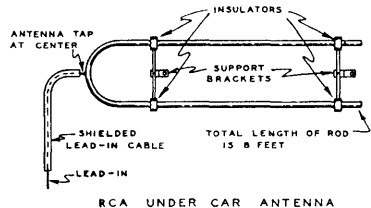

Fig. 121

Steel top automobiles call for the use of an antenna under the car. Because the receiver is connected to both the antenna and the car body, the capacity between the two should be as low as possible. Road clearance dictates the limit of spacing.

Three types of antennas for automobile installation are shown in Figs. 121, 122 and 123. The RCA "U" antenna is interesting because it resonates at about 7 meters, where the maximum ignition noise energy occurs. Noise voltages are picked up by the two sides of this "U" and arrive at the

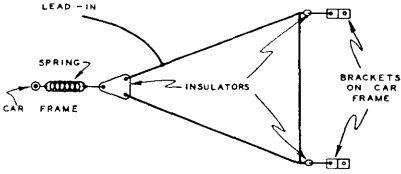

Fig. 122
Triangular Antenna.

lead-in point out-of-phase and thus tend to cancel each other. Broadcast signals, being of longer wavelength, act on the antenna as if the two rods were in parallel, and proceed through the lead-in to the receiver.

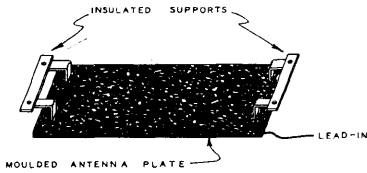

Fig. 123
Solid Metal Plate Antenna.

Front and rear bumpers can be insulated from the car chassis and used as an antenna. Many of these systems use impedance matching transformers for improved performance.

The Faraday Screen

● An electrostatic shield between two coils is often used in receiver circuits in order

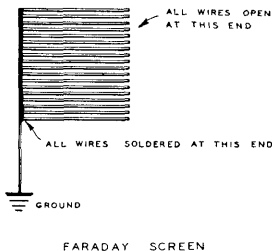

Fig. 125

to prevent capacitive coupling. One very effective arrangement is known as the *Faraday Screen*. It generally consists of a row of small wires, spaced from each other and connected together at one end in order to provide a connection to ground. Eddy current losses are prevented by grounding only one end of the wire, the other end remaining open; see Figs. 124 and 125.

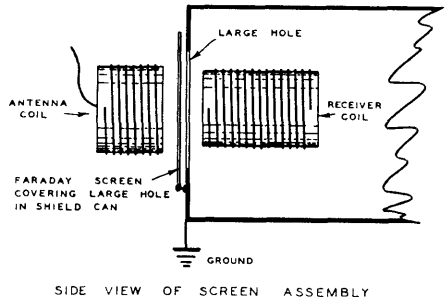

Fig. 124

A Faraday Screen can be constructed by winding a large number of turns of very small insulated wire on a cardboard drum, which has first been treated with insulating varnish. The wire is wound as on any ordinary coil, then a coating of insulating varnish is applied to the winding. After it has dried, the coil is cut in half, along its length, and flattened out. The insulation is then removed from one end and the wires soldered together, as shown in the diagram.

Aircraft Antennas

● Antennas designed for aircraft must have a good effective height and very low wind resistance. The most efficient antenna electrically is a long trailing wire for both transmitting and receiving. It must be reeled-in when a landing is made, and it offers an excessive wind load at high speeds. For beacon reception, a hollow streamlined metal rod approximately six feet in height and mounted on top of the fuselage is quite widely used. The rod must be insulated from the supporting structure. It has an effective height of about one meter, thus making it satisfactory for use with a sensitive receiver. Other forms of antennas, such as wires stretched across the wings, or from the tail to the ends of the wings, or from tail to cockpit, are satisfactory for both transmitting and receiving.

A short trailing wire, approximately 25 feet long, can be used on high speed transport planes because it has less wind resistance than a rod or pole antenna.

Marine Antennas

● Single wire antennas of the Inverted-L, T and Doublet types are used on shipboard. The wire is usually suspended between masts, or between mast and funnel. A separate antenna is widely used for short-wave reception, while for longer wave operation a break-in keying relay connects the receiver to the main transmitting antenna. Marconi antennas for small marine craft can be made more effective when more than one wire is used, such as in a cage or flat top antenna. Refer back to Fig. 46.

Loop Antennas

● When highly-directive transmission or reception is desired, loop antennas are used.

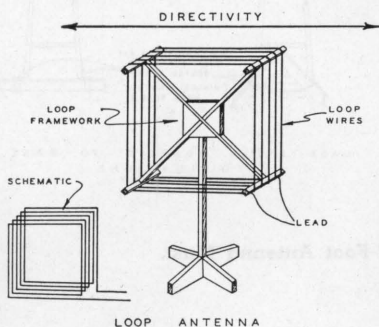

Fig. 126

A conventional type is shown in Fig. 126. Some are circular in shape, others are in the form of a rectangle or square.

The relative efficiency of loop antennas is very low and they are used only for such special applications as direction-finding. The directivity pattern has the same appearance as that of a half wave dipole antenna. The response in the maximum direction (in line with the loop) is very broad, but the minima or zero signal setting is very sharp.

Antenna Mast Construction

● A practical and economical antenna mast is illustrated in Fig. 127. It is constructed of three pieces of 2x3, or 2x4, clear pine, each 20 feet long. The completed mast is

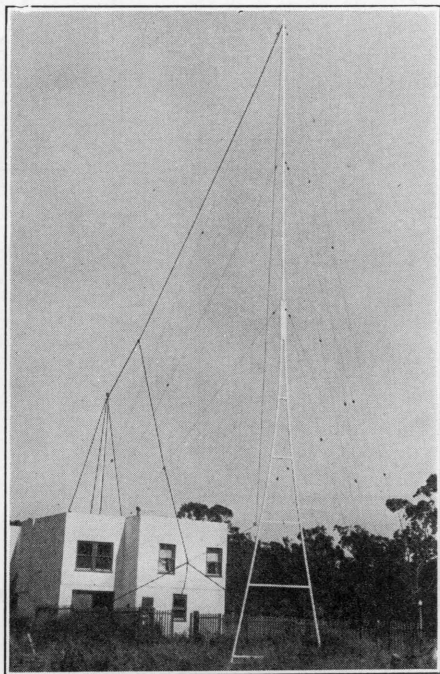

Fig. 128

Photograph of Completed Antenna Mast Described in Fig. 127.

light enough in weight for mounting on house-tops, and it can be erected by two people. The mast is guyed at the top and center with three guys at each point. The guys should be broken about every ten feet with egg-type strain insulators. The illustrations give all of the necessary constructional data.

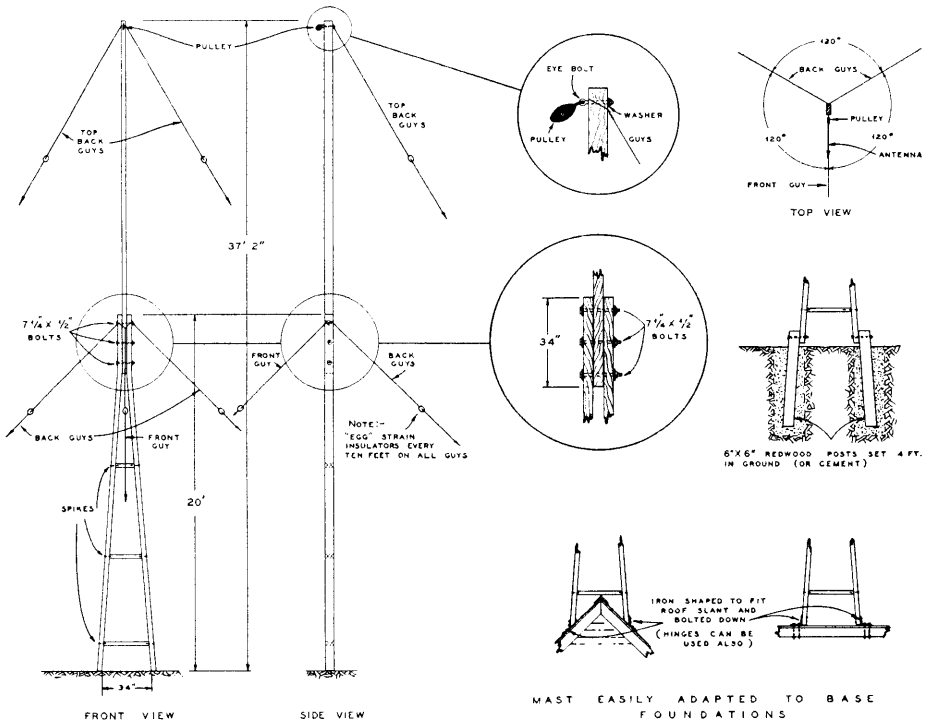

Fig. 127
Constructional Details for 37-Foot Antenna Mast.



For Memos

Notes

Notes

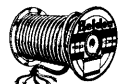

Radio Wires +

(Wires with the Plus Values of Belden's Long Experience . . . Broad Contacts . . . Constant Research)

Pioneering back in the early days of radio, Belden won a world-wide reputation for high quality wire products.

That reputation has been constantly maintained. The Belden line of radio products is the most complete available—and it is second to none in quality.

Belden Antenna Systems and Radio Wires and Cables are available through radio dealers everywhere. They are provided in handy, easy-to-use spools or packages in a broad range of types and quantities. The following are leading items in the Belden line:

- Aerial Wire
- All-Rubber Lead-in and Ground Wire
- Shielded Lead-in Wire
- Twisted Pair Lead-in Wire
- Multiple Conductor Cable for all requirements
- Rubber Sheathed Microphone Cable for all requirements
- Magnet Wire
- A.C.-D.C. Resistance Cord
- Hook-up Wire—plain and special
- Lead Wire for Test Prods
- Indoor Aerial Wire
- Electrical Cords
- Soldering Iron Replacement Cords
- Arresters
- Lead-in Strips

- Complete Antenna Systems
- Broadcast Aerial Kits
- Auto-Radio Wires and Shielding
- Couplers
- Ground Clamps
- Insulators

SEND THIS COUPON for Complete Belden Bulletin

Belden Manufacturing Company
 4647-C W. Van Buren St., Chicago

Please send today complete information on
 Belden Radio Products.

Name

Address

City

State

TELEVISION
with
CATHODE RAYS
ARTHUR H. HALLORAN



One
Year
SUPPLEMENTARY
SERVICE.. *Included*
without Extra Charge

FULL PRICE \$2.75

What You Get in Addition to a Copy of this book:

●The price (\$2.75 per copy) includes a one-year supplementary service, consisting of at least 100 pages of vital technical data on Television. You merely insert these supplements in a loose-leaf binder which you receive with your copy of the book. The first supplement is ready now . . . it tells you how to solve intricate mathematical formulae by an entirely new and heretofore undisclosed method, a contribution by the author which has won wide acclaim. This first supplement is alone worth the price of the entire book.

Television Progress Has Been Amazing

● This Authoritative
Book Brings the
Engineering Facts To You

"TELEVISION WITH CATHODE RAYS"

By Arthur H. Halloran

●The sale of this book has taken a pronounced increase in recent weeks. Editors of radio magazines and newspapers have acclaimed it as a reliable, authoritative work. It tells you how Television with Cathode Rays is accomplished by means of the Farnsworth and RCA Systems. If you have a knowledge of general radio theory you will find this book one of the most valuable technical works ever produced. It is published in loose-leaf format, so that additional pages can be included as they are issued by the author. Thus the book automatically keeps itself up-to-date in this fast-moving new engineering field. All that can be authentically and accurately related about modern Television at this time is found in this book. And when a major new technical development "breaks," you will find the data in this book. Keep your eye on Television . . . wise radio men are devoting their spare hours to a deep study of the subject NOW. Send \$2.75 for your copy of "Television With Cathode Rays." Order direct from the publisher, if your dealer cannot supply you.

PACIFIC RADIO PUBLISHING Co., Inc.
Post Office Box 3278 San Francisco, California

“Amateur Radiotelephony”

By Frank C. Jones



Many types of new Radiotelephones, from 20 watts to a kilowatt, are described in this newest Jones book . . . ready January 10th, 1937.

Ten-meter Phones, new high-power Phones for 5, 20, 75 and 160 meters, are shown in complete detail.

6L6, 6L6G, 807, 808 and several other entirely new tubes not yet announced to the public are incorporated in these modern Jones Phone Transmitters.

“Amateur Radiotelephony” is a most comprehensive treatise for the Phone-Man. Dozens of beautiful illustrations and many new circuit diagrams. You will get more out of your Phone Transmitter with this book as your authoritative guide.

50c Per Copy

From Your Dealer

or

Pacific Radio Publishing Co., Inc.

Post Office Box 3278

San Francisco, California

FOR TRANSFORMERS AMATEURS ARE TURNING TO STANCOR

EVERY day, in increasing numbers, amateur Radio Operators, the world over, are expressing their preference for Stancor Transformers.

More and more they are learning to rely on the three features embodied in every STANCOR product—Quality, Performance, and Economy. STANCOR Transformers and Chokes are manufactured by an organization that studies your needs and builds its products to fulfill them.

Insist on STANCOR.

Look for the Complete Description of the Frank C. Jones STANCOR PHONE TRANSMITTER

Here is just the rig you have been looking for. Easy to build, simple to operate, very moderately priced. Its immediate acceptance has already proven this Transmitter to be the most popular of its type ever developed.

A complete description with circuit diagram and operating data are shown in the "Amateur Radiotelephony," by Frank C. Jones. Send for your copy today. Use coupon below.

MAIL THE COUPON
FOR COMPLETE DESCRIPTION

2nd EDITION NOW AVAILABLE

The new Stancor Transmitter Manual is off the press with complete specifications for nine tested transmitter circuits of various types, also seven modulators and speech amplifiers. It's a complete handbook on transmitter design.

Send the coupon today and your copy will be mailed immediately.



Your Jobber
Recommends



MAIL THIS COUPON

STANDARD TRANSFORMER CORPORATION
864 Blackhawk St., Chicago, Ill.

- I am enclosing 25c for Stancor Transmitter Manual.
- Please send complete description of the Frank C. Jones-Stancor Phone Transmitter, absolutely free.

Name
Address

A new edition is ready now

Jones Radio Handbook FOR 1937



● Formerly called "THE 'RADIO' HANDBOOK", the 1937 edition of this valuable work now comes to you with a new title—"JONES RADIO HANDBOOK". It has been greatly enlarged in size, with many new chapters. The new Chapter on Transmitter and Receiver Tubes is alone worth more than the price of the book. Almost 300 types of tubes are analyzed; there are dozens of circuits that show you how to get more out of your tubes. The exclusive technical notes on the newer metal receiver tubes, and the many exclusive characteristics computed by Jones from actual laboratory practice, are of great value to every radio man. There is a Chapter on Diathermy, another on Television, and a marvelous Chapter on Transmitter Frequency Control, with more than 100 diagrams, showing proper tube combinations for oscillators, doublers, buffers and

amplifiers for phone and cw operation. The new Jones Oscillator that functions on many bands from a single crystal, one tube, one circuit . . . and without buffer or doubler stages, is one of the outstanding contributions to radio. The new Jones Exciter that gives you crystal control on 5-meters is another achievement of merit. Dozens of new sets are shown . . . receivers, pre-selectors, cw transmitters and phones. New test sets that can be built at home will interest the laboratory-minded experimenter. This is a great Handbook . . . literally a complete course of instruction in radio . . . right up-to-date. There is nothing "just as good" . . . for this is a Handbook by a Radio Engineer who long ago graduated from commercial radio. Written so that YOU can understand it. Complex radio problems are explained in simple language.

20 Chapters.

Electrical Fundamentals.
Radio Fundamentals.
Charts and Formulae.
Decibel Tables and Charts.
Telegraph Code Instruction.
Receiver Design Theory.
Receiver Construction.
Receiver Circuits.
Transmitter Theory.

Transmitter Construction.
Transmitter Frequency Control.
Grid-Drive Calculations.
Radiotelephone Theory.
Radiotelephone Construction.
Antenna Theory & Construction.

460 Pages.

Diathermy Equipment.
Cathode-Ray Television.
Receiver Tube Analyses.
Transmitter Tube Analyses.
Test Instruments.
Power Supplies.
U.H.F. and Micro-Waves.

PRICE \$150 PER COPY

ASK FOR IT BY NAME—"JONES RADIO HANDBOOK."
If Your Dealer Cannot Supply You, Order Your Copy From:

PACIFIC RADIO PUBLISHING CO., INC.

Post Office Box 3278

San Francisco, California