

FUNDAMENTAL PRINCIPLES OF

**VIBRATOR  
POWER SUPPLY  
DESIGN**

*Compiled and Published by*  
P. R. MALLORY & CO., INC.  
INDIANAPOLIS 6, INDIANA

FIRST EDITION • MARCH 1947

*Reproduction or use, without express permission, of editorial or pictorial content, in any manner,  
is prohibited. No patent liability is assumed with respect to the use  
of the information contained herein.*

*Entire Contents Copyrighted 1947 by P. R. Mallory & Co., Inc., Indianapolis, Indiana, U.S.A.*

*Copyright Under International Copyright Union*

*All Rights Reserved Under Inter-American Copyright Union (1910)*

*By P. R. Mallory & Co., Inc.*

PRINTED IN U. S. A.

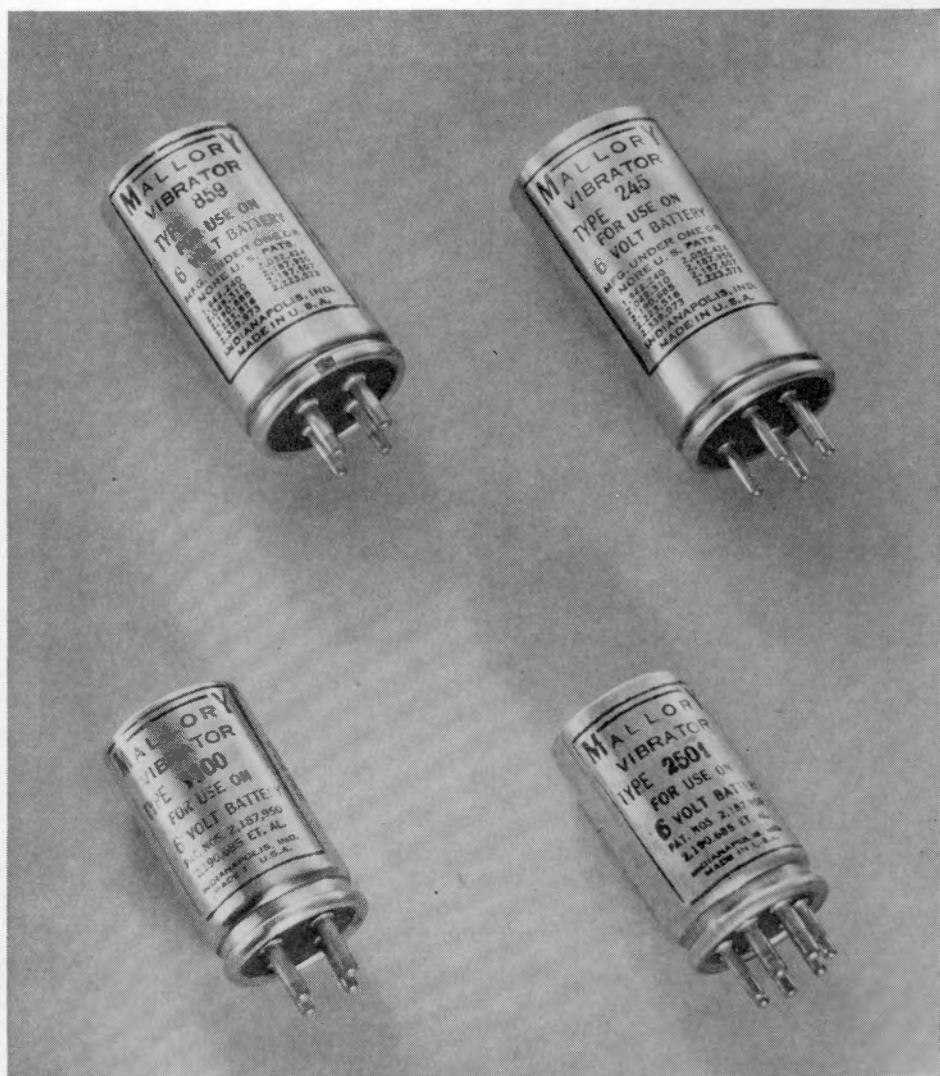

**TYPICAL MALLORY VIBRATORS**

UPPER LEFT—TYPE 659 or 859

UPPER RIGHT—TYPE 45 or 245

LOWER LEFT—TYPE 1000 or 1100

LOWER RIGHT—TYPE 2501

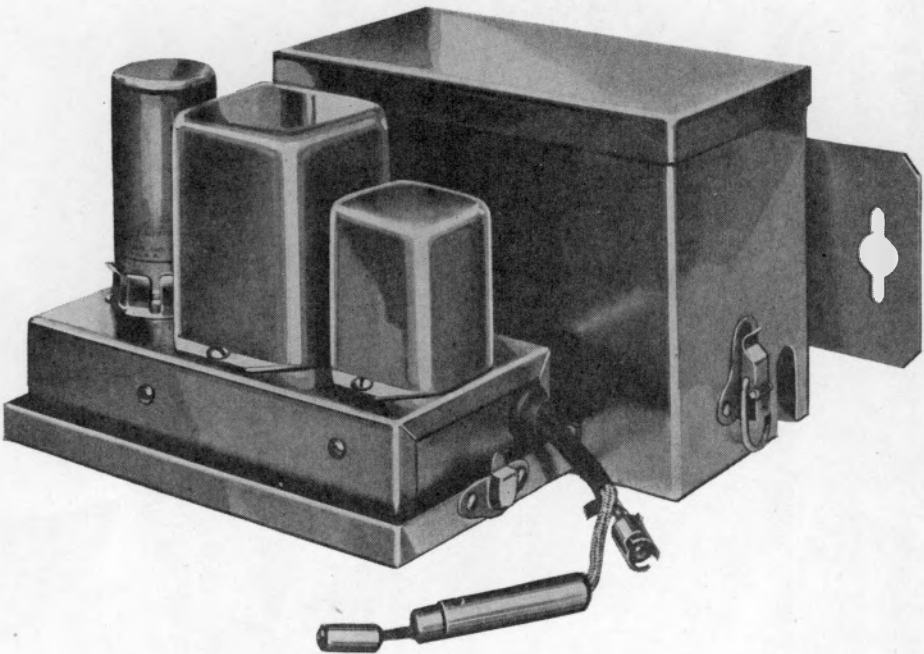

A TYPICAL VIBRATOR POWER SUPPLY UNIT  
*Self Contained*

MALLORY VIBRAPACK TYPE VP-540

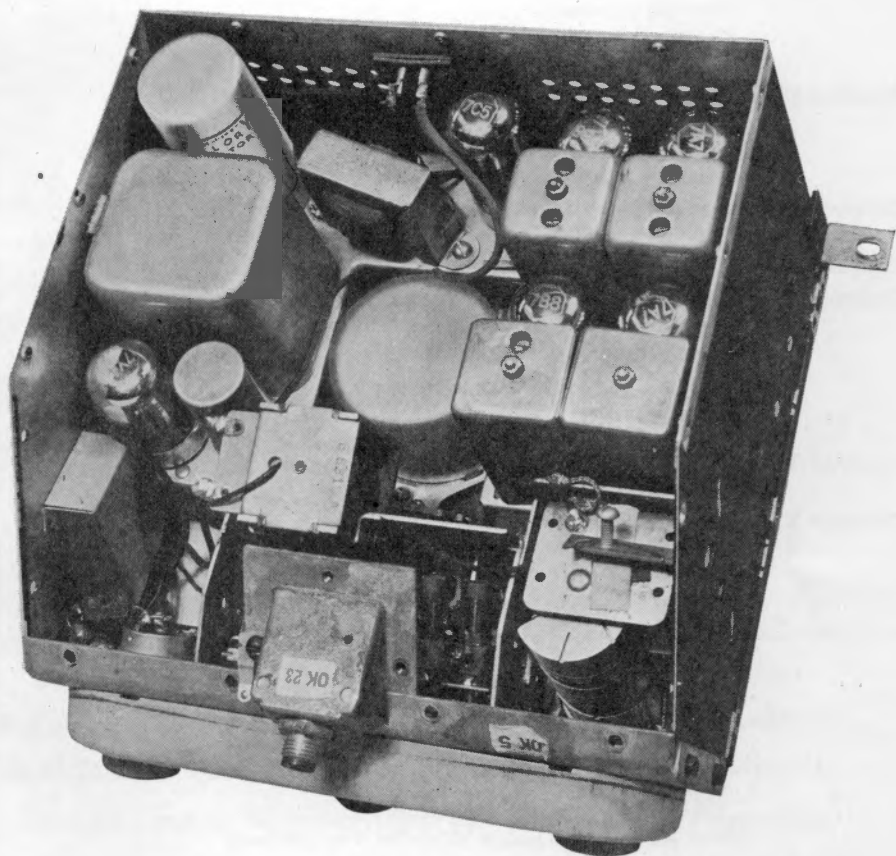

A TYPICAL VIBRATOR POWER SUPPLY SECTION  
*of an automobile radio receiver.*

# TABLE OF CONTENTS

	Page
<b>Chapter I</b>	<b>General</b> . . . . . 9
<b>Chapter II</b>	<b>Basic Vibrator Structures</b> . . . . . 13
	General . . . . . 13
	Basic Types . . . . . 13
	Driving Systems . . . . . 13
	Contacts . . . . . 15
	Load Limitations . . . . . 16
<b>Chapter III</b>	<b>Mallory Standard Vibrators</b> . . . . . 17
	Mechanisms . . . . . 17
	Frequency . . . . . 20
	Mallory Standard Types . . . . . 21
<b>Chapter IV</b>	<b>Preliminary Design Considerations</b> . . . . . 23
	Information Required Before the Design Can Be Started . . . . . 23
<b>Chapter V</b>	<b>The Choice of a Vibrator</b> . . . . . 29
<b>Chapter VI</b>	<b>Basic Power Transformer Characteristics</b> . . . . . 33
	Transformer Starting Characteristics . . . . . 36
	Transformer Core Characteristics . . . . . 40
	Core Steel Grades . . . . . 43
	Leakage Inductance . . . . . 44
	Coil Construction . . . . . 46
<b>Chapter VII</b>	<b>Tables, Charts, Graphs and Formulas</b> . . . . . 49
	Design Formulas . . . . . 50
<b>Chapter VIII</b>	<b>Development of Basic Transformer Formula with Design Examples</b> . . . . . 65
	Auto Radio Power Units . . . . . 65
	Primary Turns . . . . . 68
	Core Area . . . . . 68
	Flux Density . . . . . 68
	Wire Size . . . . . 69
	Coil Design . . . . . 71
	Impregnation . . . . . 74
	Lamination Size . . . . . 76
	Coil Resistance . . . . . 76
	Transformer Design Procedure . . . . . 77
	No. 1—Sample Design Vibrator Transformer . . . . . 78
	No. 2—Sample Design Vibrator Transformer . . . . . 83
	Low Output 6-Volt Power Units . . . . . 88
	Low Output 2-Volt and 4-Volt Power Units . . . . . 89
	No. 3—Sample Design Vibrator Transformer . . . . . 91
	Twelve-Volt, 24-Volt and 32-Volt Power Units . . . . . 95
	High-Frequency Vibrator Power Units . . . . . 99
	No. 4—Sample Design Vibrator Transformer . . . . . 101
<b>Chapter IX</b>	<b>Timing Capacitor Considerations</b> . . . . . 107
	Application of the Timing Capacitor Equation to the Determination of Values for the Sample Designs . . . . . 117
<b>Chapter X</b>	<b>Vibrator Power Supply Construction and Interference Elimination</b> . . . . . 119
<b>Chapter XI</b>	<b>Vibrator Power Supply Circuits</b> . . . . . 125
<b>Chapter XII</b>	<b>Inspection of Vibrators</b> . . . . . 131

# INTRODUCTION

---

■ *Vibrator Power Supply Systems have been used for many years to obtain high voltage currents from low voltage direct current sources.*

*This text concerns the underlying principles of Vibrator Power Supply Systems and their application problems. It has been compiled to present information, heretofore not readily available, in a unified and easily accessible form.*

*Engineers and trained technicians, who are familiar with the usual principles of alternating current power supply designs used in electronic equipment, will find it a convenient guide for the design of Vibrator Power Supply Systems and the solution of the application problems peculiar to this type of power supply.*

# GENERAL

■ Many types of electrical devices or electronic equipment, originally designed to be operated from alternating current, are frequently required to operate where such a source of power is not available, as in automotive, marine and aircraft installations. Alternating current is also difficult to obtain in rural communities and for the operation of portable equipment. Under most of these conditions there is generally direct current available from storage or dry batteries.

Motor generators, dynamotors and vibrators have been successfully used commercially to provide a power link between these DC sources of power and the electrical equipment. This is accomplished by using one of these pieces of equipment to convert the DC to AC. It may be used as alternating current or rectified to supply a different DC voltage to the equipment.

During the last several years, vibrator power supply systems have largely replaced dynamotors and motor-generators for medium and low power requirements. The higher efficiency, smaller size, lighter

weight, quiet operation and lower cost of the vibrator supply system have been major reasons for its wide acceptance.

This text will be limited to the study of problems involved in the adapting of vibrator power supply systems to the more commonly encountered applications. These include the supply of DC to radio and audio amplifiers for plate, screen, and bias voltages; low-voltage AC or DC for electronic tube heater power, relay operation, and such services. Nominal input voltages usually encountered in design work include 2, 4, 6, 12, 24 and 32 volts from storage batteries, and 1½, 3 and 6 volts from dry batteries. When storage batteries are used, the type of charging circuit and the presence of a voltage regulator system, if used, will establish the actual operating voltage and determine the range of the input voltage over which the equipment must satisfactorily operate.

To adapt vibrator power supply systems to these power sources, and to enable the designer to correctly select the type of vibrator mechanism to use for a given ap-

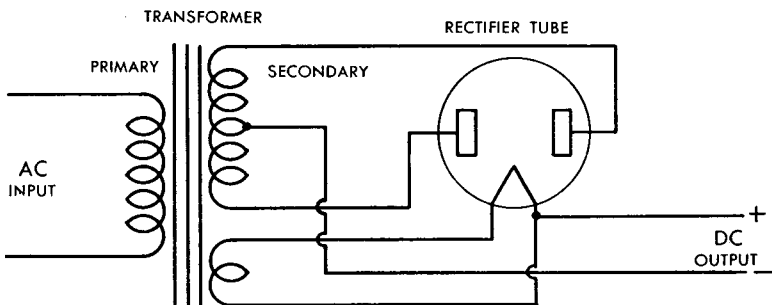

FIGURE 1



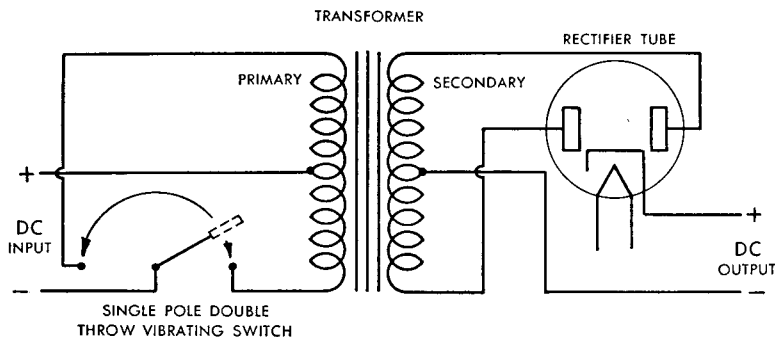

FIGURE 2

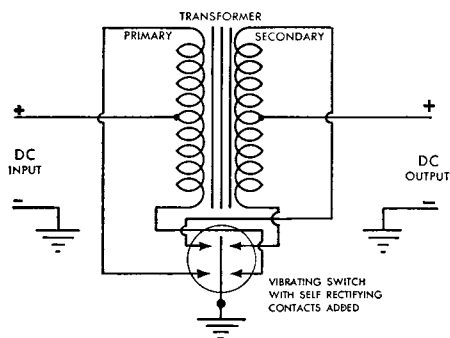

FIGURE 3

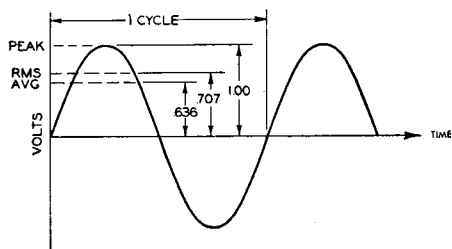

FIGURE 4

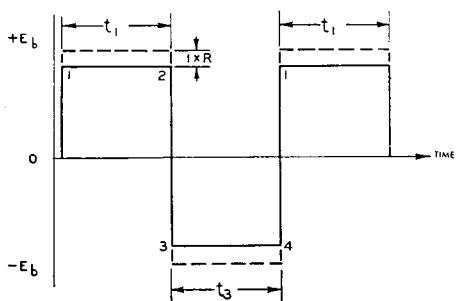

FIGURE 5

plication, it is essential that the basic principles of the vibrator be understood.

The vibrator mechanism is essentially a vibrating switch, so designed and constructed as to operate automatically at a predetermined frequency by electro-magnetic action, and thus periodically control opening and closing of one or more electrical circuits.

Figure 1 illustrates the common method of alternating current conversion to direct current for power supplies of the nature discussed. Figure 2 illustrates the means used to secure the same result from direct current by using a vibrating switch, while Figure 3 illustrates an elaboration of the vibrating switch to provide for rectification without the use of the tube. Through the proper choice and design of these associated circuits, the vibrator system can be made to act as an alternating current generator having the same frequency as that of the vibrator.

The basic difference between the AC output of the vibrator system and that of a motor generator or dynamotor lies in the shape of the voltage wave-form produced.

The output of a rotating AC generator has a wave-form essentially that of a sine-wave (see Figure 4), in which the instantaneous value of voltage is continuously varying and has no discontinuities appearing during the complete cycle. The RMS (Root-Mean-Square) value of voltage is 70.7% of the maximum (peak) value, while the average value is 63.6% of the maximum (peak) value. The output of a vi-

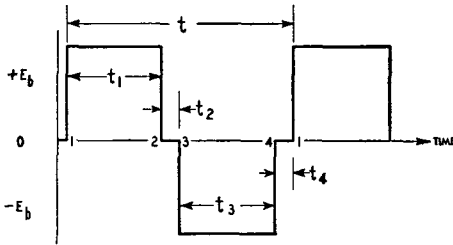

FIGURE 6

brator system of the commonly used type has a wave-form that differs considerably from the sine-wave. In its ideal form, it consists of a rectangular-shaped wave (see Figure 5) wherein the height of the horizontal portions above or below the zero axis is determined by the input DC voltage minus the series "IR" voltage drop, and the vertical portions represent an instantaneous reversal of voltage accomplished by an equivalent instantaneous operation of the switching action in the vibrator. In its practical form, a definite time interval elapses between the opening of one set of contacts and the closing of the opposite set, which is referred to as the "off-contact" time interval. This produces a discontinuity in the wave-form, during which time the applied voltage is reduced to zero (see Figure 6).

For various production and operating reasons, this value of "off-contact" time ( $t_2$  and  $t_4$  of Figure 6), is made an appre-

ciable portion of the entire time for one cycle. If the "off-contact" time is made too short, small variations occurring in the manufacture of the vibrator result in too great a variation in operating performance. This will be evident in later discussions. Also, small variations resulting from normal wear during operation will result in rapid changes in performance and a decrease in vibrator life. If the "off-contact" time is made too large a percentage of the total time, the time efficiency is reduced, with a resultant reduction in overall power efficiency and output. Therefore, the "off-contact" time ( $t_2$  and  $t_4$ ) is usually made from 10% to 30% of the total cycle time. The remaining portion of the cycle ( $t_1$  and  $t_3$ ), during which the contacts are made, "on-contact" time, therefore, totals from 70% to 90% of the complete cycle and this is referred to as the "time-efficiency" of the vibrator.

The peak value of the AC wave developed by the vibrator system is the battery-voltage less the IR drop. The RMS value is the peak value multiplied by the square root of the Time-Efficiency expressed as a decimal. Thus, the greater the Time-Efficiency of the vibrator, the greater will be the RMS voltage applied to the transformer primary. In the case of a vibrator system AC wave, the RMS value is roughly equal to the average value.

Practically all vibrator power supply systems have the vibrator working in the

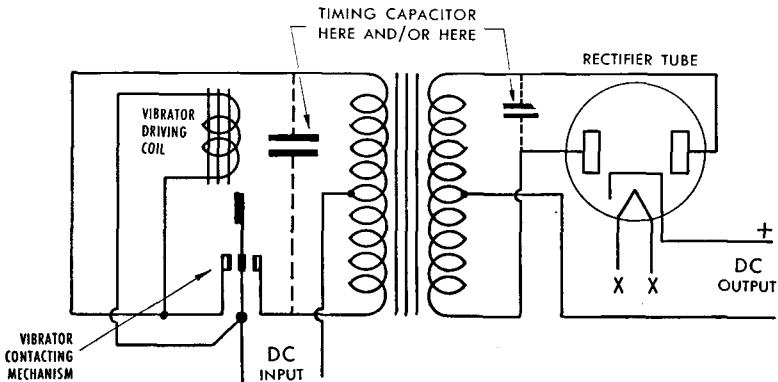

FIGURE 7

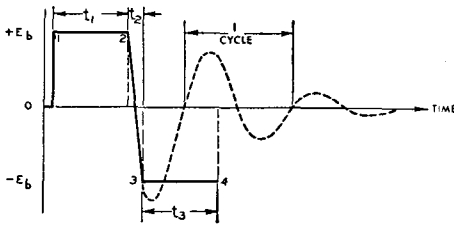

FIGURE 8

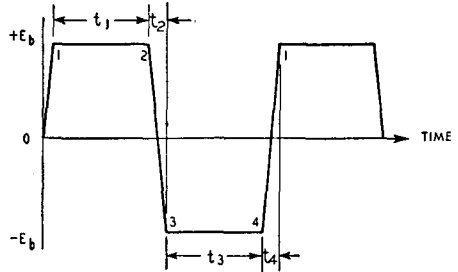

FIGURE 9

primary circuit of a transformer, the primary of which is center-tapped and so connected that the flow of current controlled by the vibrator will produce an alternating magnetic flux in the transformer core. See Figure 7. Since this transformer is an inductive load connected to the direct current circuit through the vibrator contacts, high induced voltages would be generated at each make and break of the contacts unless some means of control is provided. These high induced voltages, if not controlled, could not only cause a breakdown of the insulation but also would result in severe arcing at the vibrator contacts and thus shorten the life of the vibrator.

To control these high induced voltages during the vibrator "off-contact" interval, it is necessary to connect a capacitor of the proper value across one of the windings of the transformer (shown in dashed lines in Figure 7). This value of capacitance combines with the effective inductance of the transformer winding to form a tuned circuit, which is set into shock oscillation at each opening of the contacts. By properly selecting the value of capacitance to match the transformer and vibrator characteristics, the resulting oscillation can be made to perform the useful function of reversing the induced voltage so that it coincides with the voltage applied to the transformer by the closing of the vibrator contacts on the succeeding half-cycle. This is represented in Figure 8 by the line from point #2 through point #3. If the contacts did not close at point #3, the normal voltage decay curve would then be represented by the dotted line.

The addition of a capacitance across a winding of the transformer somewhat

changes the wave-form, removing the sharp discontinuities and causing the vertical lines connecting the horizontal portions to assume a slope. Figure 9 illustrates this wave-form, which is considered an idealized condition but which is seldom realized in practice. This condition will be discussed in a chapter on the subject of "Timing Capacitance." The slope of these connecting lines will change the ratio of the RMS to peak value of the wave-form discussed previously. The change is negligible for high time-efficiency vibrators and of a small amount for lower time-efficiency vibrators.

*This interdependence of the vibrator, transformer and timing capacitor in producing satisfactory performance and good vibrator life is the basis for the general recommendation that all vibrator power supply design data, including the components themselves, be submitted to the vibrator manufacturer for analysis before the vibrator is approved for use in the power supply.* Tolerances and variations which are usually permissible in the manufacture and testing of ordinary AC power transformers are unacceptable when applied to transformers used in vibrator power supplies. In the same way, tolerances and voltage-breakdown characteristics of timing capacitors must be carefully selected to insure satisfactory performance when used in vibrator power supplies. Vibrators themselves are subject to manufacturing tolerances, as well as certain changes during their life because of wear, and all of these variations, in combination, must be carefully considered in making the final design.

# Basic Vibrator Structures

---

## General

The basic vibrator mechanism is an assembly of five principal parts:

- 1—a heavy rigid frame
- 2—an electro-magnetic coil mounted on one end of this frame
- 3—a flexible reed or armature, one end of which is rigidly fastened to the end of the frame opposite the coil
- 4—one or more contact-carrying members attached to each side of the reed
- 5—one or more semi-fixed contact-carrying members mounted on each side of the reed and at the same end of the frame as the reed

The assembly of items 3, 4 and 5 is sometimes called the "stack." The semi-fixed contact-carrying members are insulated from other members of the stack by insulation blocks.

Variations of this basic structure may consist of multiple contact-carrying members on each side of the reed, or of the addition of a set of contact-carrying elements to provide for another type of electro-magnetic driving system.

## Basic Types

There are two electrical types using this standard basic structure. The simplest form is known as the Interrupter Type. The more complex form is known as the Self-Rectifying Type. The descriptive names "Synchronous" and "Synchronous Rectifying" applying to the Self-Rectifying Type are gradually being discarded.

The interrupter type of unit, as the name implies, interrupts the input battery current and switches it to the proper transformer windings so as to produce the desired alternating magnetic flux in the transformer core. With the interrupter type of unit, rectification is accomplished by the use of an additional piece of equipment. This may be a high-vacuum or gas-filled electronic tube, or a metallic disk rectifier. The self-rectifying type of unit, however, not only performs the function of the interrupter unit, but also incorporates additional pairs of contacts which are connected to the secondary windings of the transformer so as to provide a unidirectional flow of current; that is, it also "rectifies" the AC output voltage of the transformer. Figures 1, 2 and 3 illustrate the AC, Interrupter and Self-Rectifying simplified circuits, respectively.

## Driving Systems

Two types of electromagnetic actuating, or driving systems are used in vibrators. These types are known as the SHUNT-COIL and the SEPARATE-DRIVER systems, so called because of the manner in which the coils are energized and de-energized from the supply battery circuit.

In the shunt-coil type, the electro-magnetic driving coil has one end of its winding grounded to the frame of the vibrator mechanism, which in turn is connected to the reed. The other end of its winding is connected to the insulated semi-fixed contact-carrying member on the "interrupter pull" side of the reed. Thus, when the reed is "pulled" by the magnetic attraction of

the energized coil, the contacts close and the coil is shorted electrically. This allows the magnetic flux to collapse, which releases the "pull" on the reed. The energy stored in the deflected reed causes a reverse swing of the reed through the neutral position and beyond, where the opposite pair of contacts are then closed. Since this action is caused by the inertia of the moving reed, this latter pair of contacts is referred to as the "interrupter inertia" contacts. During the inertia swing of the reed, the current in the coil has been increasing so that, by the time the inertia contacts have opened, sufficient magnetic pull has been established to impart a large pulse of energy to the moving reed as it approaches the pole piece of the coil. The cycle is then repeated.

The shunt-coil type of unit is characterized by the fact that all of the contacts are separated when at rest, and all of the contacts are power-handling contacts. Figure 7 illustrates the connection of this type of vibrator driving system. It will be noted that the coil is so connected that one-half of the transformer primary is in series with it and the battery. The driving coil resistance is much greater than that of the transformer coil in series with it (as much as 500 times as great), so that practically all of the battery voltage is across the coil when the unit is being started. After the unit has started, the counter e.m.f. generated in the series transformer primary coil when the inertia-contacts are closed is added to the battery voltage to aid in driving the unit. Thus, after starting, a unit operating from a 6-volt battery will have almost 12 volts driving the operating coil. On vibrators for use at a single input voltage, the shunt-coil connections are made internally. However, where it is desired to operate the vibrator at more than one input voltage (such as for both 6- and 12-volt service), the coil lead normally connected to the pull-interrupter contact can be brought to a base pin for external connection, either directly or through a dropping resistor, to the pull-interrupter socket connection.

The separate driver type of system differs from the shunt-coil type principally

in that an additional pair of normally closed contacts is required in the mechanism and the voltage applied to the coil is always the battery voltage. One end of the coil winding is connected to a base pin and the other end is connected to one of the added pair of contacts. The opposing contact is electrically connected to the reed, which is in turn connected to one terminal of the battery. When the base pin is connected to the other terminal of the battery, current flows through the coil and the contacts in series with it. This creates a magnetic pull on the reed which causes a deflection of the reed toward the coil. This reed movement closes the pull-interrupter contacts of the power circuit and opens the driver contacts, thus breaking the current flow through the driving coil and releasing the magnetic attraction on the reed. The inertia of the reed carries the reed past the neutral position, in the same manner as described for the shunt-coil type, and the driver-contacts close. Thus, the current again gradually builds up in the driving coil. A further swing of the reed causes the inertia-interrupter contacts to close the power circuit, after which the reverse swing begins. At this point the coil magnetism has increased to a value sufficient to impart a strong power impulse to the reed and the cycle is repeated.

The separate driver type of unit is characterized by the fact that, while all of the power-contacts are separated when the reed is at rest, the driver contacts are necessarily closed. Figure 10 illustrates the connections of this type of driving system. Because the voltage applied to the coil is only one-half of that applied to the coil of the shunt-coil type, the resistance of the coil of a separate driver unit is roughly only one-fourth of that of the shunt-coil designed for operating at the same battery voltage. Precious metal contacts are usually used for the driver contacts, since the power handled by the driver contacts is rather low and because of the necessity of maintaining low contact resistance under the low pressure existing at rest.

Because of the mechanical arrangement necessary for the proper functioning of the driver contact, this addition to the basic

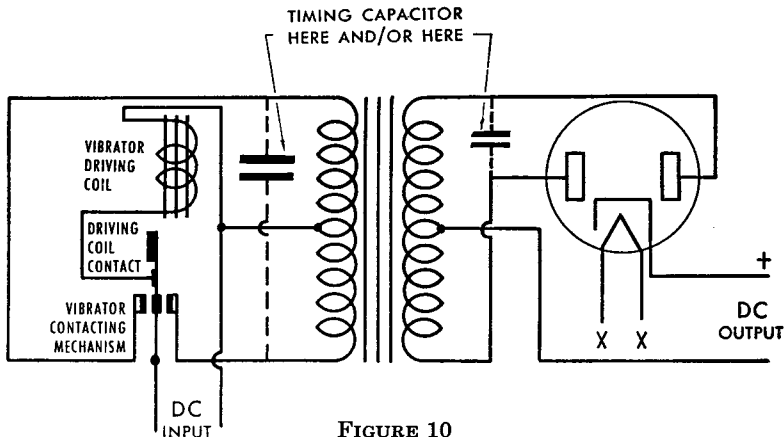

FIGURE 10

structure creates somewhat of an unbalance in the dynamic operation of the unit. As can be readily seen, the spring assembly offers opposition to the movement of the reed in the inertia direction and assists the movement in the pull direction. These effects must be minimized in the design in order to produce a unit that operates with reasonable uniformity on both halves of the cycle. The separate driver unit also requires one additional pin or socket connection, as compared with the shunt-coil unit.

Each of these two types of driving systems is particularly adaptable to certain conditions of operation. The standard Malloy vibrator line uses the shunt-coil system for all medium-frequency vibrators operating at nominal input voltage of 4 volts or higher, while the separate driver system is usually favored for 2-volt medium-frequency vibrators and for high-frequency units.

## Contacts

Contact resistance refers to the electrical resistance existing across the inter-face of two mating contacts, and not to the internal resistance of the contact material itself. In the case of most vibrator contacting materials, the most common of which is tungsten, the internal resistance is negligible compared to the inter-face resistance when operating at the contact

pressures existing in the average vibrator structure. Tests, and observations based upon experience, indicate that contact resistance is not constant for a given vibrator over a range of current passed through the contacts. At low values of current the resistance is high, then drops rapidly and becomes fairly uniform, then begins to rise more rapidly as the current rises until, at the upper current limit of the unit, the resistance is increasing at an exceedingly fast rate. It is this variable resistance characteristic that largely determines the current-handling ability of a vibrator, since over-heating of the contacts themselves is the principal cause of early failure or short life. This characteristic has a cumulative effect and results in a run-away condition under continuous operation when certain limits are exceeded. It is, therefore, necessary to establish maximum values of current and input voltages for each type of unit.

The effects of excessive voltage upon vibrators is both direct and indirect. The direct effects are those of voltage-break-down, both of the contact gap and of the insulation, and the ability to maintain arcs across the contacts following the "break." The self-rectifying unit is more critical in these respects. The indirect effect concerns the heating of the contacts caused by any arcing during the "make" and "break" intervals. The distance over which the arc will be maintained, and the

time of its duration, will increase with an increase in applied voltage. The energy of the arc will be the average current through it multiplied by the average voltage across it, multiplied by the length of time the arc is maintained. Therefore, there is a reduction in maximum current rating of the same vibrator mechanism when operated at higher voltage inputs.

Operation of vibrators under intermittent conditions permits an increase in the maximum current ratings, depending upon the specific conditions. Very short periods of operation and long "off" periods, such as in emergency transmitters and similar applications, would permit greater current ratings than for continuous operation. The ability to absorb and dissipate the heat generated is the basis for determination of maximum current ratings.

Years of experience have proved tungsten to be by far the most successful and practical of all contact materials for use as

rectifier contacts and for most interrupter contacts. Such factors as low voltage, high frequency and other unusual applications sometimes necessitate the use of special interrupter contact materials. These are normally a special silver alloy. Mallory medium frequency standard vibrators use the highest grade of cut tungsten contacts.

### Load Limitations

The principal factors limiting the loading of vibrators are heat, current, and voltage. Over-heating changes the characteristics of the contact surfaces, destroys the spring qualities of flexing parts, and adversely affects the electrical and sound insulating mediums. Ambient temperature automatically limits the dispersal of heat from the vibrator mechanism for a given internal temperature. The greater the temperature difference between the vibrator and the surrounding air and surfaces, the higher will be the rate of transfer of the generated heat. Internal heating is caused by the dissipation of electrical energy in the driving coil, in the contact resistance voltage drop, and in the sparking<sup>1</sup> between the contacts. The ability of the mechanism to transfer this heat to the outside air and conducting surfaces through the sound and electrical insulating structures determines the temperature rise above the ambient temperature that will exist as the result of a given loading.

---

<sup>1</sup> In vibrator engineering discussions, there is a differentiation made between the "arcing" and "sparking" at the contacts. "Sparking" is normally present in any vibrator application, and is generally beneficial in keeping contact surfaces clean. It consists of a group of pin-point sparks dancing around the surface of the contacts during "make" and "break." "Arcing" is detrimental in that it causes rapid erosion and transfer of contact material. An "arc" is of such high intensity that it is maintained for an appreciable period of the "off-contact" time and has a flaming characteristic.

## Mallory Standard Vibrators

---

■ The shunt-coil system employs a simplified mechanism as compared to the separate-driver system, for it requires fewer parts and adjustments. In the great majority of applications it gives equal or better performance and reliability at lower cost. Mallory has manufactured vibrators using both types of driving systems, but for many years has used the shunt-coil system on all of their standard vibrators. The millions of satisfactory shunt coil type vibrators manufactured have proved the merit of this type of driving mechanism.

However, in the case of power supplies designed to provide a very low-wattage output, there are very good reasons, from an electrical standpoint, for using a separate-driver type of vibrator. This is especially true if the conservation of input-current is a major consideration. An excellent example of such a situation is that encountered in the operation of small portable radio receivers from a 2-volt storage battery, or from dry cell batteries, where battery life is very important. Under these conditions, a more efficient power supply can be designed around the separate-driver type of vibrator. As mentioned previously, the driving coil current is isolated from the transformer primary winding. This eliminates the appreciable current unbalance between the two halves of this winding which exists with the shunt-coil unit operating at very low power levels. This unbalance is negligible in the usual application, but becomes quite apparent and even objectionable in extremely low-wattage applications. Mallory engineers have developed a special vibrator for this application incorporating the separate-driver sys-

tem. It is felt that the advantages from the electrical standpoint outweigh other mechanical and cost considerations. Also, voltages of 2 volts or less require the use of special power contact materials that will provide minimum contact resistance at low current and low contact pressures.

In the operation of vibrators at high reed frequencies, the maintenance of all of the desirable vibrator characteristics is just as important as it is in the medium-frequency vibrators, but is much more difficult to achieve. In the high frequency vibrator such factors as good contact pressure, good starting and satisfactory time-efficiency at the higher frequency present problems which are best met by use of the separate-driver system, together with special power contact materials.

### Mechanisms

Mallory standard vibrators use four general classes of vibrating and contacting mechanisms, employing four and eight power contacts. The four-contact units employ a synchronized mechanism in which the compliant reed arms (the reed arms flexing under impact) carrying the contacts are mounted on each side of the reed. The reed arms and their contacts are matched so that the frequency of oscillation of the two members is the same. They are selected with respect to those of the reed, so that their frequency is an odd multiple of the frequency of the reed. This results in a tuned mechanical circuit with characteristics similar to those of a low-loss or "High Q" electrical circuit. This type of mechanism is appropriately called



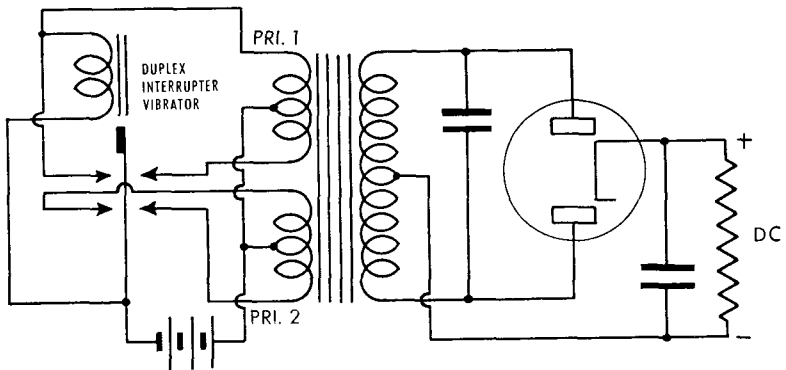

FIGURE 11

the "Q" type vibrator.

Because of the synchronization principle, the contacts close with very low relative velocity, eliminating bounce and chatter. They open with comparatively high velocity, thus furnishing a quick "break" with correspondingly short duration of any sparking that may occur. The same principle provides a contact mating with practically no wiping motion between the contacts, thus greatly reducing the major cause of contact erosion. By reducing erosion, the contact spacings are maintained reasonably constant throughout the life of the vibrator. This in turn provides substantially constant time-efficiency and output. The synchronization principle also assures greater uniformity of production.

In contrast to the four-contact units, the standard 115-cycle eight-contact vibrators employ mechanisms which do not rely upon any relative synchronization of the oscillating members to provide superior contacting action. These mechanisms were primarily designed as self-rectifying units, which by their very nature did not lend themselves readily to the tuned principle. The compliance (flexing under impact), is built into the semi-fixed contact-carrying members rather than into the ones mounted upon the reed. Since these members consist of spring steel, relatively heavy soft-steel "stops" are placed against each spring to provide a means of securing adjustment of contact spacings. These stops also provide a damping medium against which the springs expend their

stored energy during their "off-contact" interval oscillations, and also provide for a quick "break" between the contacts upon the return swing of the reed. The contact-carrying members mounted upon the reed are comparatively heavy and stiff soft-steel arms. In order to accommodate the four pairs of contacts, two pairs are arranged side by side on each side of the reed.

When operating as a self-rectifying vibrator, the interrupter contacts are spaced closer together than the rectifying contacts, and thus close the primary circuit of the transformer a short time interval before the secondary circuit of the transformer is closed and the load applied to the system. In this manner the load is applied to the vibrator in the rectifying section, where low-current at high-voltage is commutated, rather than in the interrupter section, where high-current at low-voltage would have to be commutated. This greatly improves the load-handling ability of the vibrator by reducing contact heating and erosion, and reduces to some extent the interference generated in the primary circuit.

When operating as an interrupter vibrator, the contact pairs are all spaced approximately the same. Both contact pairs on each side of the reed are operated in parallel into the primary of the transformer. This mechanism is essentially the same as operating two 4-contact vibrators in parallel thus permitting greater current-handling capacity than can be handled by the four-contact "Q" vibrators.

When operating as a duplex-interrupter vibrator, the contact pairs are spaced the same as for the regular interrupter. Each set of contacts (left and right) operates into a separate but identical primary on the transformer, which are essentially in parallel in supplying the secondary load. This permits greater current handling by the whole vibrator than is possible with the regular eight-contact interrupter vibrator. Figure 11 illustrates the duplex-interrupter circuit.

The high-frequency vibrator is a self-rectifying type carrying 8 power contacts and is separately driven by a driver coil, making a total of ten contacts in all. The contact spacings are identical with those of the 115-cycle self-rectifying vibrator. This mechanism employs a rigid armature with a flexible hinge section. In this vibrator the compliance is built into the contact arms mounted on the armature making it similar to the "Q" type. However, this vibrator is not a synchronized type as special damper springs are placed between the contact arms and the armature to damp the natural oscillation of the contact arms.

The two-volt vibrator, operating at medium frequency, is similar to the high-frequency vibrator in that it is a self-rectifying unit employing eight power contacts and two additional contacts for the separate driver coil. In this mechanism, the reed is of flexible material with a weight on the end. The compliances are in both the contact-carrying reed arms and the co-operating contact bearing side springs. This mechanism is not synchronized or "tuned," as the relatively large contact masses on the end of the light reed arms damp their natural oscillation.

Figures 12 and 13 illustrate the general construction and assembly of the four-contact and the eight-contact mechanisms, respectively, with individual components identified.

## Frequency

The more or less standard power-line frequency of 60 cycles-per-second was originally determined by the characteristics

that could be built into rotating generators. However, engineers realized that a higher frequency would be desirable for vibrator power supplies. Within certain limits, as the frequency of operation is increased, the size of the transformer can be reduced with a possible reduction in the size of other components. However, there is a point where the rapidly-increasing core-losses of the transformer (plus the difficulty of manufacture of small core sizes with large wire diameters), and the increased driving power for the vibrator, reduce the overall efficiency to such an extent that the increase of frequency beyond a certain point is not desirable. Other factors affect the operating frequency, especially in radio or sound applications, where the effect of the transmitted mechanical

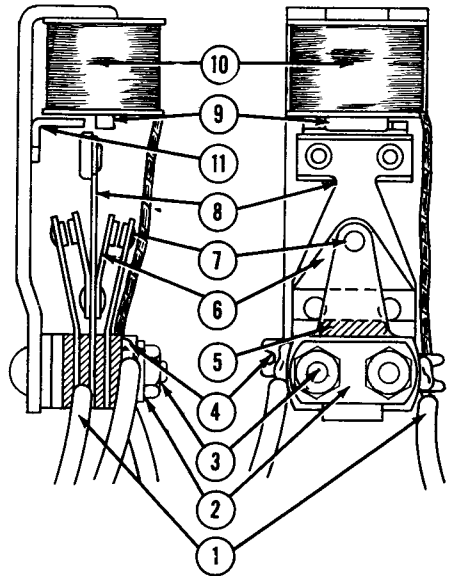

FIGURE 12

1. Stranded leads with insulated covering
2. Spring pressure-plate
3. Stack clamping screws
4. Spacers and solder-lugs
5. Reed-slot for improved starting
6. Reed contact-arms
7. Outer (or side) contact-arms
8. Reed and armature
9. Pole-piece integral with frame
10. Driving coil
11. Magnetic shunt

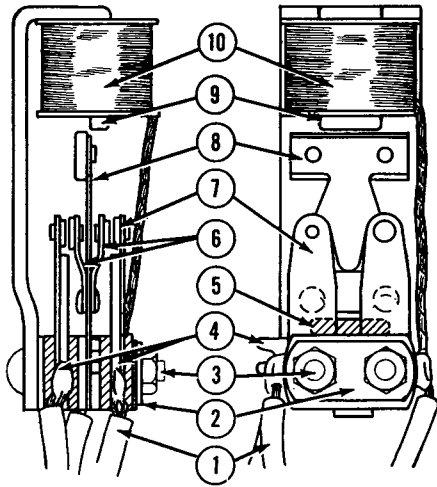

FIGURE 13

1. Stranded leads with insulated covering
2. Spring pressure-plate
3. Stack clamping screws
4. Spacers, stops, and solder-lugs
5. Reed-slot for improved starting
6. Reed contact-arms
7. Outer (or side) contact-arms
8. Reed and armature
9. Pole-piece integral with frame
10. Driving coil

noise from the vibrator and the electrical hum appearing as a ripple voltage on the direct current output must be considered.

The acoustic sensitivity of the ear increases with an increase in the frequency in the lower frequency spectrum. Therefore, an increase in the vibrator frequency results in an apparent increase in the mechanical noise radiated from the vibrator even though the actual level of the radiated energy is the same or less than radiated at the lower frequency. Electrical filters of the "low-pass" type nominally have greater filtering ability as the frequency is increased, hence, it would be expected that the ripple voltage (twice the vibrator frequency) would be reduced as the vibrator frequency is increased. Undoubtedly this is true, yet the apparent hum appearing in the transducer output may often increase with an increase in vibrator frequency. The ear sensitivity to frequency may increase faster than the

ripple voltage is reduced; the hum frequency may rise above the spurious local noise frequencies and thus become more noticeable, or the hum frequency may fall within a resonant frequency band of the transducer diaphragm or other vibrating members of the system and thus be over-emphasized.

When the mechanical, electrical and aural complications are all considered in their proper importance, the standard medium frequency of 115 cycles per second is at present most satisfactory. Mallory standard medium-frequency vibrators are all designed to operate at a nominal frequency of 115 cycles per second. This basic frequency offers a combination of a reasonable size of the vibrator and transformer, comparatively low noise and ripple frequency, good electrical efficiency, and excellent contact life. A factor not too often considered is that of contact life based upon the total number of makes and breaks possible before the contacts are worn out. Assuming that equivalent operating circuits, loads and operating performances are involved, the higher the frequency of operation used the higher will be the rate of wear, and, therefore, the shorter will be the life of the vibrator in hours of service.

As the art of vibrator design progressed, it seemed quite possible that vibrators of higher frequency would be developed with improved characteristics, and a second basic frequency would be adopted.

At the request of the Military Services, the Mallory engineering and research sections undertook to thoroughly and carefully analyze the possibility of producing a vibrator which would operate at a much higher frequency than the previous standard of 115 cycles, and equal or surpass the quality of performance of the lower-frequency units. This investigation was to be directed toward determining the highest frequency at which a satisfactory vibrator could be produced. However, as a coordinated project, a determination was to be made of the approximate point in the increasing frequency spectrum where the size and weight of the associated components ceased to decrease appreciably as

the frequency was increased. This was included since the major purpose in increasing the vibrator frequency was to reduce the size of the vibrator, if possible, and to reduce the size and weight of the transformer and other components required in the power unit.

After many sample vibrators had been designed and built for tests, and suitable components investigated for use with each, it was determined that a frequency of 250 cycles per second could be attained in a suitable design. At higher frequencies the rate of reduction in the size of components became negligible and the inherent difficulties involved in obtaining satisfactory operation of the vibrator increased. Even the use of new and improved materials in the transformer does not permit operation at a much higher frequency (insofar as a reduction in size and weight is concerned) and does result in a large increase in overall cost of the power-supply unit. Therefore, engineering effort was concentrated on development of a unit for operation at a frequency of 250 cycles per second. This effort resulted in the introduction of a new vibrator, of the self-rectifying type, having an enclosure size of approximately  $1\frac{5}{16}$ " diameter by  $2\frac{3}{8}$ " long. The overall power-unit size is reduced not only by the reduction in component size resulting from the higher frequency, but also by the elimination of the rectifying tube.

## Mallory Standard Types

There are many combinations of mechanisms, container sizes, bases, and operating coils that have been produced by Mallory and have type numbers assigned to them. To adequately list and identify each of these units would be too involved and complicated to be of much service to the designer. Therefore, the intent of this section is to list the various types under a series identification. Other characteristic information and data appears on Vibrator Characteristic Data Sheets that are published separately.

The various basic types, and their designations are as follows:

1. The "Q" Series: 4-contact, full-wave, synchronized interrupter vibrator, acting as a single-pole, double-throw switch, with shunt-coil driving system. Frequency 115 c.p.s. Standard Type—Type 659 (859).
2. The "MQ" Series: Same description as for the "Q" Series, but built into a smaller mechanism. Frequency 115 c.p.s. Standard Type—Type 1000 (1100).
3. The "Jr. 90" Series: 8-contact, full-wave, interrupter vibrator, acting as a single-pole, double-throw switch, with shunt-coil driving system. Frequency 115 c.p.s. Standard Type—Type 94 (294).
4. The "Jr. 65" Series: 8-contact, full-wave, duplex interrupter vibrator, acting as a double-pole, double-throw switch with the two poles electrically common, with shunt-coil driving system. Frequency 115 c.p.s.—No Standard Type.
5. The "Jr. 40" Series: 8-contact, full-wave, self-rectifying vibrator, acting as a double-pole, double-throw switch, with the two poles electrically common, with shunt-coil driving stem. Frequency — 115 c.p.s. Standard Types—Type 45 (245), Type 46 (246) and Type 49 (249).
6. The "B" Series: 10-contact, full-wave, self-rectifying vibrator, acting as a double-pole, double-throw switch, with the two poles electrically common with two contacts used in a separate-driver system. Frequency—115 c.p.s. No Standard Type.
7. The 250-1 Series: 10-contact, full-wave, self-rectifying vibrator, acting as a double-pole, double-throw switch, with the two poles electrically common, with two contacts being used in a separate-driver system. Frequency —250 c.p.s. Standard Type—Type 2501.

## Preliminary Design Considerations

---

■ Many direct and indirect factors have an important bearing on the overall design of the power supply system and to the selection of the most suitable type of vibrator in particular. All of these factors must be given careful consideration before proceeding with the actual design work. The satisfactory performance of the vibrator power supply system will depend on the correct correlation of this information. The various problems which must be considered before design work is started have been arranged in the form of questions on the pages immediately following. After each group of questions is a discussion covering the problems in greater detail.

### Information Required before the Design Can Be Started

I. *What kind of equipment is the power supply to operate?*

- (a) What frequency ranges are involved, if radio or television apparatus? "RF" amplifier range? "IF" amplifier range?
- (b) Is there any adjacent radio equipment that may be affected?
- (c) If an audio amplifier, what gain is used?
- (d) If for other types of equipment, what other critical characteristics are involved?

It is important to know the character of the equipment to be powered since the amount of interference, or "hash," filtering required for satisfactory performance, depends upon the sensitivity or gain, the shielding, and the frequency ranges of the tuned circuits. If the equipment is not

radio or sound apparatus, or if the character is such that radio and hum interference does not affect its satisfactory performance, then considerable space, cost, material, and engineering time can be eliminated. The inclusion or elimination of these filter components affects the basic design by changing the primary and secondary circuit resistances, thus affecting the effective applied voltage and the resultant output voltage.

II. *Which of the following is most important?*

- (a) Size and weight?
- (b) Cost?
- (c) Quality of performance?
- (d) Long life of components?
- (e) Economy of battery consumption?

From this group it must be determined which factor is of greatest importance in making the final design.

Often factors beyond control of the designer are the ones determining the final design. The design may require the smallest, lightest weight product obtainable, at the sacrifice of some performance, life of components, efficiency, and even cost. Or the emphasis may be placed upon input current economy, regardless of weight and cost.

Quite often, however, the cost factor is the primary consideration and design compromises must be made. Sometimes these compromises are carried too far and inferior designed components are used or essential elements eliminated resulting in costly production and field difficulties. It is the degree to which these compromises may be made and still retain acceptable

performance standards that determines the overall success of the final design. In this phase, knowledge, experience and skill of design and layout play a most important part.

### III. *What output load is required from the power unit in current and voltage?*

- (a) Are these factors measured ahead of or following any smoothing filter that may be required? Is the IR voltage drop in the filter included in the above load rating?
- (b) If a smoothing filter is required, what are the electrical values of its components, i.e., the choke inductance and resistance, the capacitance value and voltage rating of the input and output capacitors?
- (c) Is more than one output load required?
- (d) Must any output voltage be regulated?

With the above general considerations determined, the first design detail usually involves the measuring, or computation of output load required from the power supply. This may be expressed as watts, volts across a given impedance, current through a given impedance, or current at a given voltage.

Normally it is most convenient to use the latter method or to convert to it if specified in any of the other ways. This voltage value may be specified either ahead of or after the filter system. It is sometimes desirable to specify the voltage value ahead of the filter since, under certain conditions, power is delivered at this point as well as through the filter. Such an arrangement permits the heavy current supplied to the output power tubes to be diverted from the filter. This allows the use of a higher resistance choke or merely a resistor in the filter without incurring a large voltage drop, and probably will result in a greater smoothing effect. This emphasizes the desirability of having a general idea of the filter arrangement to be used and the value of the components to be incorporated in it. Circuits that can be supplied with a minimum of filtering are those incorporating a minimum of amplification between them and the output. Examples are: speaker, meter, final transmitter amplifiers, etc.,

and these may conceivably be fed from the input to the filter while the filtered output can supply the high-gain circuits and sensitive devices.

Vibrator power supplies almost invariably use a capacitor-input filter for several reasons. The effect upon the vibrator operation is the most important. The tank, or storage, effect of the input capacitor greatly aids the commutating ability of the vibrator. Most applications are substantially constant load devices where the added regulation advantage of the choke-input filter is not essential. The size of the input capacitance varies with the current requirements, but with the availability of electrolytic capacitors for most of the output voltages encountered, it is fairly common practice to use a 10 or 20 mfd. capacitor in the first section. The high-voltage, low-current applications, such as for accelerating potentials for oscillographs of the cathode-ray type, electrostatic capacitors of small values, such as 0.10 to 1.0 mfd. have been used. The size of the second section is made as large as is required for filtering needs based upon the economics of the design.

In determining the total output load, it is essential to note whether more than one load is to be supplied from the single power supply. These added loads may be for tube filaments of a different voltage from that of the battery, a load at radically different voltage and current which would justify an individual output, or other special requirements. Also, it is sometimes necessary to operate a given power supply under more than one condition of loading. For instance, a single power unit may be used to provide light power for a receiver, heavier power for a small phone transmitter, or heavy pulsating power for a C.W. telegraph transmitter. This was a more or less common requirement for some military applications, and required special considerations to meet the design limitations.

### IV. *What type of primary source of power will be provided?*

- (a) Storage battery of the Lead-Acid or Edison type?

- (b) Dry batteries or other primary cells?
- (c) DC power line or generator?
- (d) If a storage battery, will the equipment operate with the battery off charge, on charge, or under both conditions?
- (e) If the equipment is operated with the battery on charge, is the charging source voltage-regulated? Is the charging capacity large enough to maintain this voltage under load?

The type of energy source and the conditions surrounding its operation should next be noted, in order to define as many of the limiting factors as possible. Usually the input source of power is a lead-acid type storage battery as used in automobiles, trucks, aircraft or boats or it may be the portable type for use only with the equipment itself. However, there are instances where the Edison type of storage cell (nickel-iron-alkali) is used. Applications also arise where primary-type cells, such as the common "dry-cell," are used to supply the input energy, and still others where generators or rectifiers are the source of power.

When storage batteries are the source of power, it is necessary to determine if the conditions of operation will require the equipment to operate while the battery is being charged, such as in a motor car. Under these conditions will the charging generator be voltage-regulated or not, and is the charging generator of sufficient capacity to maintain the regulated voltage under normal loading conditions? This will determine the voltage range over which the equipment must operate. It is definitely necessary to know or be able to make a close approximation of the answers to these factors in order to proceed with a design that will provide reasonably satisfactory results.

*V. At what input voltage will the output load of III be required?*

- (a) The output voltage (with a constant impedance load) is directly proportional to the input voltage applied to the transformer center-tap, unless special regulating devices are used. Care

must be exercised to avoid choosing a low rated input voltage and then operating at a higher voltage such that the voltage ratings of components connected in the load circuits are exceeded.

- (b) Over what range of input voltages is the equipment expected to operate satisfactorily? Minimum battery voltage when not on charge, and maximum battery voltage when on charge? Minimum and maximum line voltage of the DC line at the operating point?
- (c) It is very desirable to specify the input voltage as that measured between the center-tap of the transformer primary and the vibrator reed-ground (chassis). This avoids complications involving the various resistances appearing in the primary battery circuit. If this cannot be done, it is necessary to know, either by measurement or approximation, the value of the total resistance of this circuit which includes leads, switch, fuse, and filter choke. For best operation this resistance, of course, should be held to a minimum consistent with the primary current being drawn and the input voltage applied.

Knowing the above data with reasonable accuracy, it is possible to specify the input voltage to be applied to deliver the required output (as specified in Group III). The input and output voltages are directly proportional as long as the load impedance remains reasonably constant. Correct output may be secured by specifying the input voltage at the primary center-tap of the transformer, rather than that at the battery terminals. This requires knowledge of the components that will be inserted in the primary circuit, principally their DC resistance, in order to estimate the voltage losses in this circuit.

If the best and most efficient operation is desired, the primary resistance should be held to a minimum value consistent with the primary current and voltage. As an example, recent automobile radio receivers of the 5-tube type had a voltage-drop in the primary circuit (including

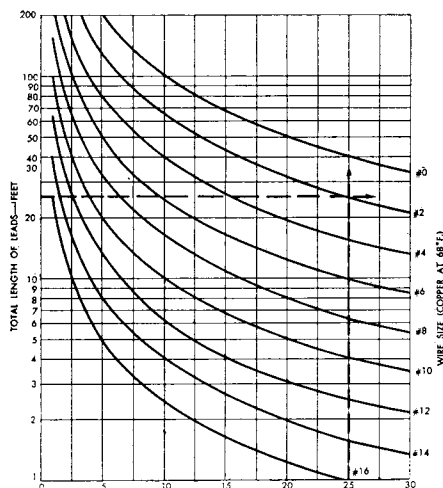

FIGURE 14

leads, fuse, switch and filters) of approximately 0.30 to 0.50 volts. The total primary resistance would be less than 70 milliohms (0.070 ohms), with approximately 2/3 of that being in the common circuit also supplying the tube heaters and dynamic speaker, the remaining 1/3 being in the input filter of the power supply. At a nominal battery voltage of 6.6 volts, the effective input voltage would be about 6.1 volts, which is a loss of 7½%. For higher input voltage systems, such as 12 or 24 volts nominal input, the same receiver design (with tubes and other components suitable for the higher input voltage) could have primary resistances of 0.280 and 1.120 ohms respectively without increasing the percentage of the voltage drop in the primary circuit to the total input voltage. The reason is that the input current would be approximately halved while the input voltage would be doubled, making the percentage effect change by a 4 to 1 ratio.

The chart shown in Figure 14 illustrates the importance of even small values of resistance when placed in the low-voltage, high-current circuit. This chart shows the length in feet of several sizes of wire and cable that can be used to carry different values of current and limit the voltage drop to 0.10 volts. It will be noted that the current-carrying ratings of the various

sizes are not reached before excessive voltage drops occur, or before inappropriate short lengths are involved. This chart is useful in determining the size of lead wires, as well as a guide in designing low-voltage filter chokes where voltage drop is important.

An additional, but important point of information regarding the input power source is the anticipated range of voltage over which the equipment is expected to operate. This depends largely on the points previously covered, such as the use of a charger and its capacity and regulation; also upon the experience regarding voltage variations with life, ambient temperature, rate of discharge, percentage of discharge, etc., largely encountered when using dry-cell batteries but also affecting the storage types. The range of operation has a definite effect on the loading of the vibrator, voltage rating of component parts and temperature rise.

VI. *Can one polarity of the DC output be electrically connected to one polarity of the DC input without complications?*

- (a) If not, how much voltage differential is required?
- (b) Are indirectly heated cathode-type or directly heated filament-type of electronic tubes used? (If filament-type tubes are used, it will probably be necessary to install a filament circuit hum filter to insure quiet operation.)

The circuit of the equipment to be powered should be analyzed to determine if the input and the output circuits can be electrically connected without affecting the operation of the unit. If one polarity of the battery input can be common with one polarity of the DC output, it will be possible to use either a self-rectifying or an interrupter type of vibrator. However, should separate input and output circuits be required, the interrupter type combined with a separate rectifier will have to be used. If an approach to this problem is considered before the circuit details are fixed, quite often arrangements can be made whereby either type of vibrator can be used, the choice then being made upon the relative merits of the vibrator types.



At the same time it is desirable to note whether any electronic tubes, if used in the equipment, are of the filament-type, or if they are all of the cathode-type. This affects the power supply design insofar as the isolation of the input and output circuits is concerned. It affects the amount of filtering, and might easily affect the transformer design and vibrator loading. The DC voltage from the battery has an AC ripple voltage superimposed upon it caused by the pulsating current through the vibrator drawn from the battery through leads that are common, in part, with the filament supply leads. This AC ripple impressed upon the filament of the tubes, is amplified and appears in the output circuit. If this hum is found to be objectionable, it may be reduced or eliminated by a smoothing filter placed in series with the filament supply circuit. A filter of this type usually consists of a small iron core choke of low resistance, and a low-voltage, high-capacity capacitor, in parallel with the tube filaments. *This type of hum filter should never be placed in the vibrator supply circuit to achieve the hum elimination unless the capacitor used is of sufficiently large capacity to furnish the total power required by the vibrator.* The use of such a filter in the vibrator supply circuit will result in an unsatisfactory vibrator performance unless it has been specifically engineered for the application and approved by the vibrator manufacturer. Also, any voltage drop occurring in the choke will result in a lower applied input voltage and, consequently, a lower output voltage unless the transformer is redesigned.

VII. *Will there be a period of operating during which a "no-load" condition will exist? For how long a period of time?*

- (a) If this condition exists, will it occur only at the start of operation (during tube warm-up, for instance), or will it recur intermittently during operation?
- (b) Will an intermittent operation condition similar to telegraph keying be encountered?

A "no-load" condition usually exists in the power supply during the warm-up period

immediately after the equipment is turned on. An outstanding exception is where filamentary type tubes are used and the warm-up period is so extremely short that no consideration is given to this condition. This condition also occurs in applications where the load is "intermittent" such as in "keyed" code transmitters. "No-load" conditions can occur from other causes but these are in a very small minority and are treated as special cases.

With operation at no-load, the output voltage rises to a maximum determined by the regulation of the circuit, the time-efficiency of the vibrator, and the increased input voltage caused by reduction in battery drain. Therefore, the voltage rating of the self-rectifying vibrator and the components, such as capacitors and resistors, and even tubes, may be exceeded unless this characteristic is considered at the time components are selected. The duration of the no-load operating time will sometimes determine the selection of transformer design limits and the selection of timing capacitor values for best vibrator performance. This will be more completely covered in a later chapter. This will also affect the type of rectifier that can be used. Self-rectifying vibrators, filament and cold-cathode types of rectifier tubes, and dry-disc metallic rectifiers all supply rectified DC to the output circuit as soon as the power is turned on. Cathode-type rectifier tubes have a warm-up period which approximates that of other cathode type tubes, and retards the application of output voltage until the load is applied.

VIII. *Will the power supply be operated continuously (for 5 minutes or more at a time)?*

- (a) If operation is intermittent (for less than 5 minutes at a time), will cooling periods between operation be at least equal to the running periods in length of time each?

The length of operation per cycle has a strong bearing on the type of vibrator that can be used in an application. If the unit operates for only a short cycle of a few minutes, with a comparatively long cooling period between cycles, the components can be operated at a higher loading than

when operating continuously. The short operating time prevents the generated heat from rising to values that would be dangerous to the vibrator mechanism or the transformer insulation. This condition might easily arise under longer periods of operation. Where the power supply is to be operated intermittently, the transformer generally can be smaller than would otherwise be required and the vibrator can carry higher currents.

The duration of operating cycle also affects the mechanical design as to the ventilation or heat radiating ability of the case, chassis, shields, etc. Care in providing for the efficient cooling of a continuously operating unit will permit higher power output and increase the life of the components, including the vibrator.

*IX. What will be the maximum ambient temperature under which the equipment must operate?*

- (a) What minimum ambient temperature will be encountered, (1) for storage or standby, and (2) operation?
- (b) Will either natural or forced ventilation be possible to keep the maximum temperature within safe operating limits?

The maximum ambient temperature, i.e., the temperature of the air immediately surrounding the vibrator container, under the worst conditions of operation, directly affects the anticipated life of various components, including the vibrator and electrolytic capacitors. Because excess heat shortens the life of vibrators, they should be operated at as low an ambient tempera-

ture as possible. This can be obtained by locating the equipment where good ventilation or natural drafts can be utilized; by judiciously locating the vibrator with relation to heat generating units such as rectifier tubes, power tubes, and transformers, so as to eliminate or reduce absorption from these sources; and by skillful use of a chimney-type of case ventilation.

The absolute maximum ambient temperature for the vibrator (and also electrolytic capacitors) is 85 degrees Centigrade. The ambient temperature should not exceed 55 degrees Centigrade if longest life is to be obtained. Minimum temperatures are not very critical. Vibrators will start and operate satisfactorily at any minimum temperature likely to be encountered, even in high-altitude aircraft service. After the unit has started operating, internally generated heat will gradually raise the operating temperature toward a normal value.

*X. Will all of the power supply components be assembled upon the main equipment chassis?*

- (a) If not, will a separate power-supply be used, and what components will be mounted thereon?

This involves information relative to the general construction and placement of the power supply with respect to the main equipment. It is rather self-explanatory, but bears directly upon some of the foregoing groups of design considerations. It definitely affects such parts of the overall development as "hash" elimination work, heat dissipation, ventilating, filtering, etc., and should be carefully considered.

## The Choice of a Vibrator

---

■ The selection of the most suitable vibrator can be made with relative ease. Most of the factors which govern this choice are controllable or are known at the beginning of the design work. First, there is the choice between the two basic types—the self-rectifying type and the interrupter type. Secondly, there is the selection of the most suitable container and plug arrangement. Each of the basic types of vibrators have definite advantages and their relative merits should be considered.

The self-rectifying vibrator contains rectifying elements eliminating the necessity of a separate rectifier. This reduces the space required for the power supply system and also simplifies the wiring. Considerable heat is developed by the losses in a separate rectifier and is even more pronounced when additional power is consumed by a heater element. The rectifying elements of the self-rectifying vibrator have a low internal resistance since they operate in actual physical contact with each other. Therefore, the rectification losses are small and very little heat is developed. Excessive heat adversely affects the life of the vibrator, as well as other component parts. Consequently, the life of the self-rectifying vibrator is lengthened and the ventilation problems are simplified. The lower losses also mean a definite improvement in the efficiency of the system.

The proper operation of the self-rectifying vibrator requires the contacts to be adjusted so that the interrupter contacts connect the transformer primary winding before the rectifier contacts connect the secondary and correspondingly, the rectifier contacts open before the primary contacts.

In this way, the "load" is disconnected from the transformer secondary, thereby reducing the heavy primary current before the interrupter contacts open. This greatly reduces the sparking of the interrupter contacts and consequent contact heating, resulting in better vibrator life.

The overall efficiency of a six-volt system using the self-rectifying vibrator is generally between 65% and 70% for normal loadings. The efficiency of the 250 cycle self-rectifying vibrator systems will be between 70% and 78%. The efficiency increases somewhat with higher input voltages such as 12 or 24 volts, but will decrease for lower voltages. The two-volt vibrator is an exception since it has been specifically designed for highest possible efficiency at low input voltages with low power output. These facts are based on the use of properly designed and matched component parts.

Although the initial cost of the self-rectifying vibrator is more than the cost of an equivalent interrupter vibrator, the elimination of the rectifier tube and socket with its associate wiring will result in an overall cost that usually is slightly less than the cost of an equivalent system using the interrupter vibrator.

The self-rectifying vibrator has been considered with prejudice many times because it did give some trouble during the early development period. At that time, very little was understood of its complex mechanics and critical electrical requirements. Research and development work, however, soon eliminated the troubles and for many years this vibrator has been a highly efficient, and reliable device, with

long life in service. It has been used extensively in such applications as police radios, high-quality automobile radios, rural home radios, portable radios, mobile communication and public address equipment, etc., with eminent success.

There are only two minor disadvantages of the self-rectifying vibrator which must be considered. The reed contacts of both the interrupter circuit and the rectifier circuit are mounted on a single reed and are electrically connected together. This requires that one side of the high voltage output and one side of the low voltage input be common or electrically connected together. This will not be a serious obstacle in most designs as it is quite common practice to use a cathode bias system that allows the negative polarity of the high voltage to be "grounded." Since one side of the input is also "grounded," these two parts of the circuit are connected together and the self-rectifying vibrator is satisfactory. By the use of especially devised circuits, even filament types of tubes may be used satisfactorily.

The other disadvantage is that the polarity of the output is dependent upon the polarity of the input, since the rectifier portion of the vibrator is not selective within itself as is the electronic rectifier. The manufacturers of various automobiles, trucks, boats, etc., have never standardized on the grounded polarity of their electrical systems. Some have positive grounds and some have negative grounds. This means that where a device is intended for universal use, the correct polarity must be established after the installation is made. This may be easily accomplished by a small double pole double throw "polarity reversing" switch. Another simple and economical method, developed and patented by Mallory, utilizes a seven-pin symmetrical base on the vibrator in conjunction with a corresponding socket. Since the base is symmetrical, the vibrator can be inserted in the socket in two ways. One position would be for positive ground, while rotated 180° would be for negative ground.

A summary shows that a system using the self-rectifying vibrator offers advan-

tages in size and weight, in higher efficiency and longer life in the higher power ranges. The two very minor disadvantages are normally of no serious importance.

The interrupter type vibrator is the most popular type because of its simplicity. The efficiency is somewhat lower than for an equivalent self-rectifying system, but its general use is in automotive or mobile equipment where the slightly reduced efficiency is of minor importance. A rectifier, usually the tube type, is required with this vibrator, but the additional space required seldom presents a serious design problem.

The contacts of the interrupter vibrator must make and break the total current, causing the contacts to wear somewhat faster than in the self-rectifying type. However, the life, under normal loadings, is quite adequate for the average automobile receiver. It is not unusual to find vibrators in privately-owned passenger cars which have been in use for over five years.

The overall efficiency of a six-volt system using the interrupter vibrator is generally between 60% and 65% for normal loadings. Rectifier filament or heater power has not been included in this figure because it is fairly common practice to use an ionically heated cathode rectifier, such as the OZ4. This efficiency increases somewhat with higher input voltages such as 12 or 24 volts but will decrease for lower voltages. As with the self-rectifying vibrator, these facts are based on the use of properly designed and matched component parts.

There are two very outstanding advantages of the interrupter type vibrator. First, the use of a rectifier tube completely eliminates the necessity of polarizing the input voltage; therefore no concern need be given to the grounded polarity of the input voltage when the installation is made. Second, there is a definite sales and advertising advantage in stating the number of tubes used in the radio. By using a rectifier tube, the total number of tubes is increased by one, although approved radio advertising requires that when rectifier tubes are included they be specifically listed as such.

A summary shows that the interrupter vibrator offers advantages where the polarity of the input voltage is a major consideration, where simplicity is desired and where the addition of a rectifier tube will be beneficial. The minor disadvantages should not seriously affect the choice of this vibrator for average applications.

Constant developments and improvements in methods of manufacturing have gradually improved both the self-rectifying and interrupter vibrators so that they are now reliable, efficient and economical when used within their limitations. The application considerations, such as size, weight, efficiency, simplicity of installation, etc., will determine which of these two basic vibrators are most suitable.

Specific types have been designed to meet practically all requirements. Two styles of containers have been available for the self-rectifying vibrators. The larger size has more sound-absorbing material to further reduce the acoustic noises and vibration which otherwise may be slightly audible under very quiet operating conditions as exist in rural communities. These types are generally used in six-volt battery-operated home-type radios and are of the self-rectifying type because the highest possible efficiency resulting in battery current economy is generally of utmost importance.

The choice of a vibrator should be guided by the Standard Types since they are more readily available and more economical.

## Basic Power Transformer Characteristics

---

■ The transformer used in a vibrator power supply is a very important and critical component. As one of the three principal components (the other two being the vibrator and the timing capacitor), its design and performance can control the resultant vibrator performance. Therefore, it is important that the unusual characteristics of vibrator power transformers and their effects upon vibrator operation and performance be thoroughly understood.

Several outstanding characteristics of full-wave vibrator power transformers distinguish them from similar conventional AC transformers. Vibrator transformers normally use a center-tapped primary winding to provide an electro-magnetic circuit which can produce a reversal of flux in the transformer core during consecutive half-cycles of vibrator operation. This reversal of flux is essentially an alternating flux and produces an AC voltage in the windings on the core. The reversal is accomplished by conducting the DC battery current first through one half and then through the other half of the primary winding by the alternate closing of the vibrator interrupter contacts, which are connected to the outer ends of the primary winding. Figure 7 illustrates this basic circuit. One important result of this particular characteristic is the increased winding space requirement for the primary, as compared to conventional AC transformers. This necessitates either the use of a larger core lamination or the acceptance of poorer regulation, increased copper-losses, and increased heating.

Another characteristic of vibrator transformers is that the primary winding usually

contains fairly large wire because it is operating at a comparatively low input voltage. These larger sizes have poor space factors and permit only a relatively small number of turns per layer, resulting in further inefficient use of the core "window" space. Because the available primary voltage is limited, and the current-handling ability of the vibrator is also limited, it is usually desirable to keep the primary winding resistance as low as is economically possible in order to utilize a high percentage of the total input voltage for transformation. Any portion of the input voltage used for overcoming "IR" voltage drop in any part of the primary circuit is obviously not available for transformation to secondary voltage, and thus is responsible for an increase in the voltage transformation ratio (turn ratio) over that required for the ideal case of no "IR" drop.

Another less obvious characteristic of vibrator transformers is the rather high percentage of core-window winding space that must be allotted to insulation and to mechanical support and clearance of the windings. In general, most vibrator transformers are constructed on the smaller sizes of laminations in order to meet restricted space requirements and cost limitations. However, as the laminations decrease in size, the window space becomes smaller and a greater percentage of the winding length is "wasted" because of the necessary mechanical clearances at the ends of the layers. The use of large primary wire sizes necessitates the use of thicker paper separators between layers for mechanical support only, since the voltage insulation requirement is negli-

gible. Because of the very nature of the operation of the vibrator, battery, and inductance combination, the possibility of transient voltages occurring as the result of accidentally unbalanced conditions, or from exceptional vibrator wear, is usually present in any design. Since these transient voltages are of a much higher value than the normal working voltages, it is necessary to include sufficient insulation in the design to provide an adequate safety factor to prevent transformer failure under temporarily abnormal operating circumstances.

Actually, commercial designs require as high as 15% to 20% of the window height (radially in the coil) for core and over-wrap insulation, and from 10% to 15% required for clearances, resulting in only 65% to 75% being available for wire and interlayer insulation. In the other dimension (axially along the coil), commercial practice has limited the available space for wire to from 70% for small laminations to 80% for larger laminations.

A mechanical requirement is the usual electrostatic and magnetic shield surrounding the transformer assembly. This is for the purpose of confining the magnetic field within the shield thereby preventing the flux from causing undesirable modulation in other sensitive components. This magnetic field spreads "hash" (RF) interference and the shielding reduces this troublesome effect.

Still another important characteristic of vibrator power transformers is the maximum flux-density allowable at the nominal input voltage, and the wide range of flux-density corresponding to the wide variation in input voltage. In most cases the input voltage of a vibrator power supply varies over a very much wider range than that of an AC power line, because of the state of charge of the battery, the type of battery-charging equipment, and the latter's voltage regulation.

For instance, the actual ammeter terminal voltage of an automobile (the point where most radio receivers are connected to the electrical system) may vary from about  $5\frac{1}{2}$  volts with the engine off and the lights and radio turned on, to about  $7\frac{1}{2}$

volts with the generator charging and the voltage regulator in control. With a defective regulator, or in a system without one, and with low temperatures prevailing, the voltage may rise above 9 volts under maximum charging conditions. Assuming that a nominal voltage of 6.6 volts is the mean value, the voltage would vary normally by about minus 15% and plus 20%. Under such circumstances the maximum flux-density will vary over the same plus and minus range.

With the abnormal 9.0 volt condition existing, this would correspond to a plus 35% variation, instead of the 20%. In contrast to the above, the nominal 117-volt AC line can be expected to normally vary less than plus or minus 10%. For the past several years, voltage regulators have been standard equipment on all automobiles. These regulators control the generator charging current and are adjusted to limit the maximum battery voltage to about 7.5 volts or less at about 70°F. Even under adverse conditions the voltage rarely exceeds 8.0 volts. Therefore, transformer design calculations are based on a maximum voltage of 8.0 volts.

Because of the wide range of flux-densities that must exist under the range of input voltages encountered, it is general practice to select a maximum value for the nominal operating condition that is considerably lower in value than would be used for an equivalent AC application. The ideal magnetization, or "BH," curve of the core steel would be a straight line so that the magnetizing force required would be directly proportional to the flux-density produced. The actual "BH" curve, however, falls far short of realizing this ideal. It is a decided curve having a lower and upper knee when plotted fully with rectangular co-ordinates. Figure 15 illustrates a typical "BH" curve for Allegheny-Ludlum Steel Company's "Dynamo Grade."

The ideal useful working range lies roughly between the two knees of the curve, where an approximately straight portion exists. For reasons that will be discussed at greater length later, it is desirable that the entire range of flux-density,

necessary in a given application, be confined to this comparatively straight portion. For practical engineering and economic reasons this usually cannot be accomplished, although any deviation is restricted to the smallest possible amount. Most AC transformer designs are not restricted in this respect and much higher flux-densities are usually used for the nominal line voltage condition.

Referring again to Figure 15, it will be observed that the straight line (1) has been drawn along the curve so as to parallel it between the points (A) and (B), for this particular grade of steel falls between flux-densities of 5 and 47 kilo-lines per square inch. The mean value would be 26 KL, plus or minus 21 KL, or plus or minus 81%. This would be highly satisfactory were it not for the fact that, under most circumstances, it would be uneconomical from a cost and space standpoint, to build a transformer to operate at such low flux densities. Line 2 has arbitrarily been drawn across the beginning of the upper "knee" of the curve to demonstrate how a close approximation to the straight line can be made by restriction in the range of operating flux-density. Between points (C) and (D) the flux-density falls between 40 KL and 73 KL per square inch without the magnetizing force deviating too far from a proportional rate of change. This variation can again be stated as a mean value of 56.5 KL plus or minus 29%, which is still greater than the 20% maximum variation for the input voltage change.

It can easily be seen that operation at much higher values of flux-density quickly shifts the operation point over the "knee" of the curve into the region approaching saturation of the steel. Operation of the transformer under these conditions involves high magnetizing currents, high core losses, and excessive heating. While it is not uncommon to find inexpensive AC power transformers operating at flux-densities in the region of 90 to 100 KL per square inch, it is very impractical if not impossible to work vibrator transformers at these same figures. Additional reasons will become evident as the discussion progresses.

The current used for magnetizing the core is approximately 90 degrees out of phase with the input voltage in AC transformers operating from a sine-wave source of voltage. Its wave-shape is distorted from the normal sine-wave by the curvature of the "BH" curve of the steel, but the major portion of the wave resembles a sine function. Because of the phase relationship of the voltage and current, their product in watts is virtually zero, the volt-ampere product being known as reactive power or "wattless" power. The core losses act as a resistive load upon the power line, and are included in the watts consumed.

Vibrator transformers, however, are energized from a constant voltage source, such as a battery, during the time interval that the vibrator contacts remain closed. This requires that the magnetizing current must be drawn from the battery in phase with the voltage, and, therefore, the product of the average current and the voltage becomes watts instead of wattless power.

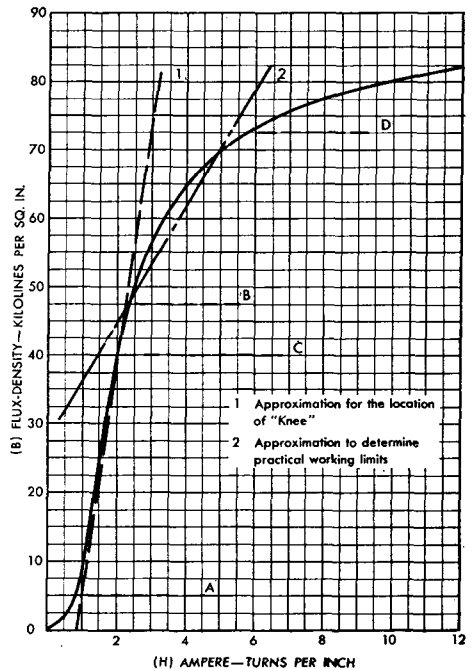

FIGURE 15



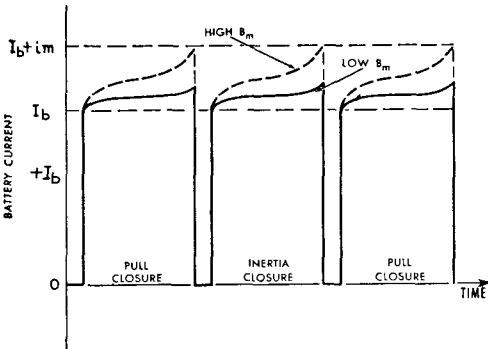

FIGURE 16

This factor in many instances affects the efficiency of the power supply to a considerable extent, especially when it is designed to operate at low input voltages and low output wattages. It may also affect the power output capabilities in critical cases, since this current must be added to the load current in determining the contact loading. The core losses again are added as an "in-phase" load, the same as in the sine-wave transformer.

Figure 16 shows the wave shape of the magnetizing current in a vibrator transformer, when operating at both low and high flux-densities, and its phase-relationship to the pulses of applied input voltage. The current starts each half-cycle at zero and increases at a comparatively slow rate until near the end of the half-cycle where the rate increases rapidly, creating a peak of current just as the vibrator contacts open. If this peak current is of very high magnitude, it will have an appreciable detrimental effect upon the contact performance. Since the peak occurs at the instant the contacts "break," its value must be added to the load current for the commutation, or contact-switching, interval. Figure 17 illustrates the wave shape of the input current pulses with the power supply operating under load. The effect of the driving coil current is omitted for clarity.

Figure 18 demonstrates the shape of the magnetic flux wave and its phase relationship to the input voltage, which is plotted as the alternating equivalent achieved by the center-tapped primary winding. The flux-wave is shown as a series of straight

lines, crossing the zero axis at the midpoint of each half cycle of input voltage, and having a zero rate of change during the "off-contact" or vibrator-switching interval. Because the applied voltage is essentially a constant value, the rate of change of the core flux must also be constant so that the induced, or counter, e.m.f. in the primary winding will have a constant value approximately equal and opposite to the applied voltage (assuming negligible voltage drops in the primary circuit). The flux varies from a maximum in one direction through zero to a maximum in the opposite direction during each half cycle, and the equivalent flux-density varies from one " $B_{max}$ " to the other " $B_{max}$ " (or through a range of  $2B_{max}$  for each half-cycle), in order to induce the required counter e.m.f.

## Transformer Starting Characteristics

The above description and Figure 18 apply to the "steady-state" (stable) operating conditions existing following the starting interval of the vibrator. The vibrator starting characteristics are quite important to the transformer but are often neglected. A serious transient condition may be imposed on the transformer by the vibrator during the first few cycles until the full operating frequency of the vibrator

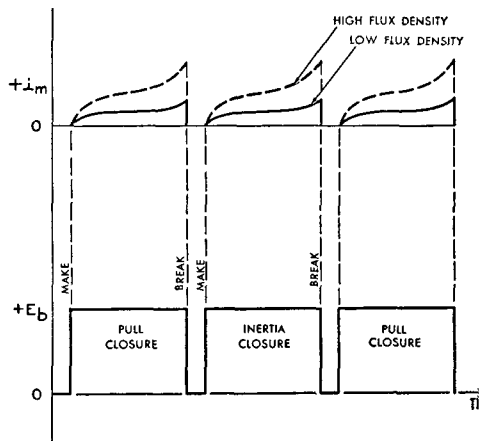

FIGURE 17

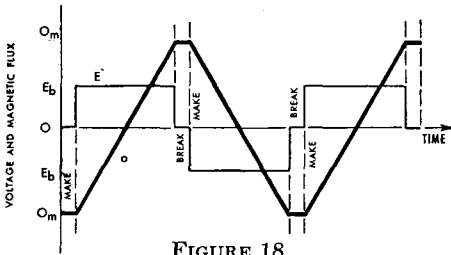

FIGURE 18

is attained. Such a condition does not exist in AC sine-wave transformers.

Vibrators do not start instantly at normal frequency and time efficiency. The moving parts possess mass and inertia, and a certain length of time is required to accelerate the parts to full amplitude and speed. Thus a transient condition arises. Some vibrator designs are better than others with regard to the rapidity with which they attain normal running characteristics. Even within any one design group, considerable variation in this characteristic exists as the result of required manufacturing tolerances and ever-changing conditions during life.

During the first few cycles of operation following the first energization of the driving coil, the amplitude of the reed is low, the frequency is low, and the balance between the pull and inertia half cycles is often poor with respect to the length of contact-dwell time. The time efficiency of the vibrator during these first cycles is lower than the normal value. As the amplitude of the reed increases these factors improve—with the frequency increasing and the balance and time efficiency improving until normal operation is attained. Some vibrator designs tested at nominal voltage, showed that only 2 to  $2\frac{1}{2}$  cycles were required to reach normal operating conditions, while others required up to 7 or 8 cycles. Similar tests made during "life tests" indicate that the starting conditions become worse with age. Again, some designs being better than others in this respect.

The effects of these temporary vibrator characteristics upon the transformer are such that the operation at low frequency causes an increase in the maximum flux-

density. This is partially counteracted by the lower time efficiency existing during this period. The degree to which one factor offsets the other depends upon the relative decrease in time efficiency with the decrease in effective frequency. Tests have indicated the decrease in time efficiency exceeds the decrease in frequency.

The matter of poor balance in time efficiency between successive half-cycles of operation is much more serious. When a vibrator does not operate in a full wave manner, generally during the starting cycle, it is said to be "single footing." It "buzzes" at low reed amplitude and makes contact only on the pull swing of the reed. This may be caused by several conditions, which are not of immediate concern, but the effect is to impress upon the core of the transformer a polarized magnetizing action which quickly builds the flux-density to a value approaching saturation. This in turn necessitates the supplying of a high magnetization current from the battery which the vibrator contacts must commutate. The result is a rapid deterioration of the contacts and possible voltage-breakdown of the transformer insulation and associated capacitors. This is the extreme condition, and a situation of unbalance falling in between "single footing" and equal balance merely reduces the seriousness of the above effects depending upon the degree of unbalance.

Since the timing capacitor value is selected for best performance of the vibrator-transformer combination under normal running conditions, it will seldom match the combination during these starting cycles. The loading upon the transformer (which includes the timing capacitor) has been observed to have a definite effect upon the ability of some vibrators to start successfully, especially after wear occasioned by age. Under the low-frequency and low-time efficiency condition existing at starting, the value of timing-capacity required to match the existing conditions would need to be much larger than that required for normal running. This would materially reduce the vibrator life and is not recognized as good engineering practice.

Another transient condition occasioned by starting is the effect of residual core magnetism upon the value of magnetization current drawn from the source during the starting cycles. This condition is common to both AC sine-wave transformers and vibrator transformers. It is a well-known fact that the current drawn immediately upon connecting a transformer to the sine-wave power source may have a peak value many times higher than the normal running value, the peak value depending upon the polarity of the residual flux and its magnitude with respect to the initial polarity of the applied voltage when the connection is made.

When the circuit is broken with the AC voltage at the positive peak value, the magnetizing current (and flux wave) lags behind the applied voltage by 90 electrical degrees. The circuit would open with a zero value of flux in the core and no residual magnetism would be present. If the circuit is closed again at the zero point of the positive half-cycle of the voltage wave, the required flux to satisfy the counter e.m.f. induction will have to vary from a zero value to  $2B_{max}$ . However, if the steady circuit is broken with the AC voltage at zero value at the finish of the positive half-cycle, the value of the flux in the core would be a positive maximum. The residual magnetism in the usual grades of silicon steel has been given as approximately 80% of the maximum value existing at the time of removal of the magnetizing force. Under these conditions, if the circuit is again closed with the AC voltage at the zero point of the positive half-cycle, the flux would have to vary from a plus 0.8 to a plus  $2.8B_{max}$  to satisfy the counter e.m.f. induction.

This is obviously a much worse magnetizing condition than the steady-state condition with the flux-density being far above the "knee" of the "B-H" curve and well into the saturation region. Actually, the regulation of the circuit limits the maximum magnetization current to a value considerably below this calculated value. For other combinations of magnetic residual polarity and initial voltage polarity, the value of maximum flux-density and

current is lower than the above, the lowest peak value occurring with the maximum residual magnetism at one polarity and the initial voltage at the opposite polarity in the correct phase relationship. Here the flux-density change required is from a minus 0.8 to a positive  $1.2 B_{max}$ . Usually quite a few cycles are required before the steady-state condition is reached. AC power sources can readily absorb this temporary overload without damage, and since there is no commutation necessary, the occurrence of this transient condition causes no damage and usually goes unnoticed.

These circumstances can also exist in the operation of vibrator transformers, but the results are far more serious than they are in sine-wave transformers. Figure 19 illustrates the two extremes that could arise in the starting of a vibrator power supply. The heavy solid-line curve represents the steady-state flux-wave, in the same manner as shown in Figure 18 and is again plotted with reference to the effective alternating DC input voltage pulses. For purposes of illustration it is assumed that the time efficiency and frequency remain constant for the starting cycles and are the same values as for the steady-state

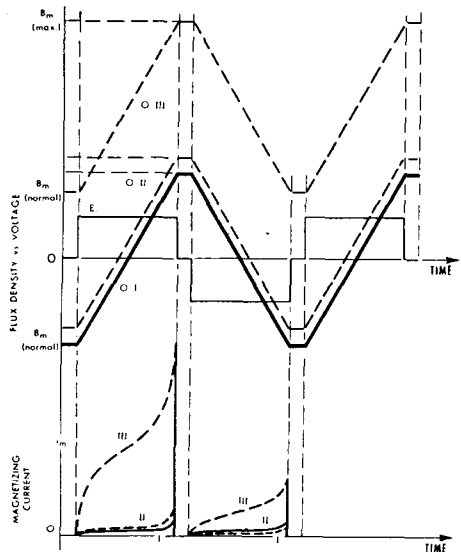

FIGURE 19

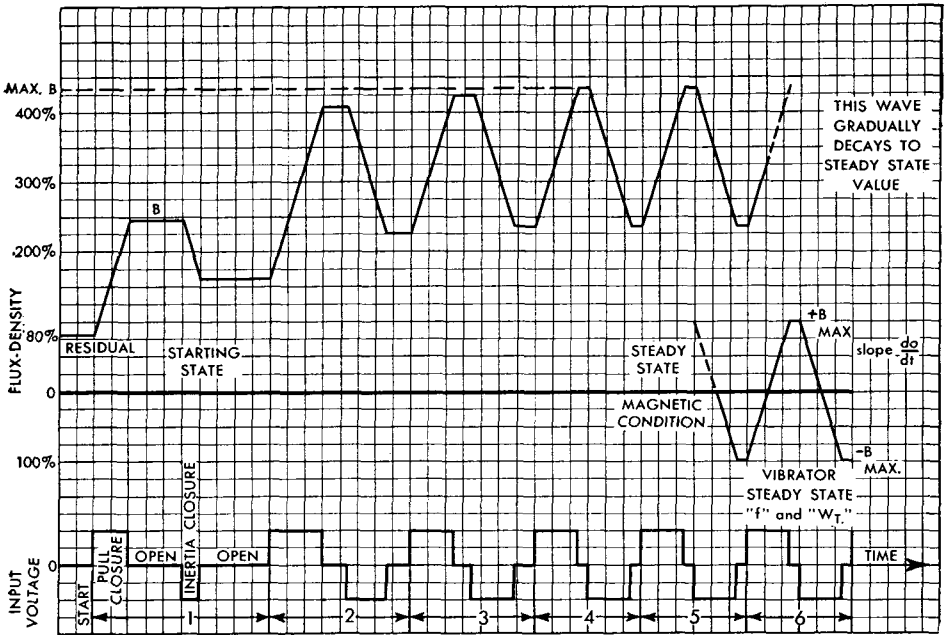

FIGURE 20

cycles. While this condition does not actually exist, the assumption is made for clarity. It is also quite possible for the transient transformer condition to last for a few cycles longer than it takes the vibrator to assume a normal running condition. The lower of the two dashed-line curves parallels the solid curve at a value slightly above the latter, and represents the initial condition of maximum opposing residual magnetism (80% of nominal maximum). The upper dashed-line curve again parallels the solid curve, but represents the other extreme of initial residual magnetism, where the polarity of the residual magnetism adds to rather than subtracts from the resultant maximum flux-density.

Because of its mechanical design the vibrator will always start with the initial contact-closure in the direction of the same polarity, although the opening of the battery circuit when stopping may occur on either polarity. This condition, combined with the fact that the vibrator starts with a complete half-cycle every time, reduces the possible combinations of residual po-

larity and starting polarity to the extent that it is far more probable that a detrimental combination will be encountered with a vibrator transformer than it is with an AC sine-wave transformer. In addition, the high magnetization current must be broken by the vibrator contacts at its peak value, which often is damaging, or even destructive, to the contacts.

The arbitrary values of magnetization currents corresponding to the several starting conditions are also plotted in Figure 19 and are in their proper phase relationship to the corresponding voltage and flux waves. The steady-state condition is also shown. The scale is only relative to show the effect and the spread of actual values would usually be much greater under the conditions described.

Figure 20 is similar to that of Figure 19, except that in this instance the variation in frequency and time efficiency during the starting cycles is considered. This variation was described earlier in this chapter. The input transformer voltage is shown at the bottom of the diagram. It is plotted to

show a hypothetical starting condition and is for illustration only. Six cycles are shown, with gradually increasing frequency from the first through the fourth, and with a poor time efficiency and balance condition in the first that improves through the fourth. Cycles five and six are duplicates of the fourth, representing the eventual steady-state condition of the vibrator.

The steady-state magnetic flux-wave necessary to induce the required counter e.m.f. is shown at the right-hand end of the zero line of flux-density. The slope of the vertical portions represents the required "rate of change of flux." Since the number of primary turns and the cross-sectional area of the core remain constant, the rate of change of flux will also remain constant regardless of the position of the flux-wave so long as the input voltage is constant. Therefore, this slope of the curve is used to project a new flux-wave curve which is matched to the transient starting condition just described. This is shown in the upper part of the diagram, where the starting point is with a residual magnetism of a positive 80% value, the most adverse condition. Under the combination of conditions shown, the maximum flux-density would reach about 435% of the normal maximum during the transient, *if no limiting factors intervened*. From this maximum the core steel would slowly return to a more or less neutral, or steady-state, magnetic condition. The time interval required is much longer than that required by the vibrator to reach its steady operating state.

A theoretical value of 283,000 lines per square inch would be indicated by 435% of a normal  $B_{max}$  of 65,000 lines and the corresponding magnetizing current would be ridiculously high. The core steel curves do not extend to such extreme figures, but it is obvious that by estimating an extension of the curves that a magnetizing force of approximately 10,000 ampere-turns per inch would be required; this compares to 4 ampere turns for the normal  $B_{max}$  of 65,000. The increase, therefore, is roughly 2,500 times. Assuming an average value of 0.5 ampere for the normal condition, this would amount to a value of 1,250 amperes for the peak condition.

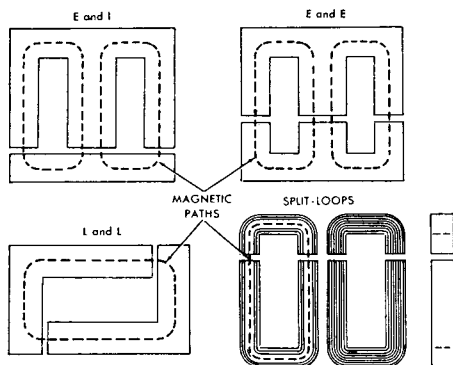

FIGURE 21

It is obvious that it would be impossible to even approach this value of current before the voltage-drop in the resistances of the source and of the primary circuit would equal the source voltage. As the effective voltage applied to the transformer primary is reduced by this voltage-drop, the required counter e.m.f. is reduced and the resultant rate of change of flux and maximum flux-density are also reduced proportionately. This results in a self-limiting condition, which affects the described theoretical graph. It will be necessary to refer to this section at a later point where the phenomenon just outlined has a definite bearing upon the performance of high-voltage input vibrators. It seems pertinent to point out, however, that this characteristic is also important to the success of attaining a good power supply design, and must be taken into account to insure satisfactory results.

## Transformer Core Characteristics

Another vibrator transformer characteristic concerns the magnetic core. As a general rule, transformers for use with vibrators have always used the so-called "shell type" of core laminations. These consist of an assembly of "E" and "I" punchings, usually interleaved so that the "I's" are fitted across the open side of the "E's" between the closed sides of other adjacent "E's." Seldom are transformers made with the "core type" of laminations, which are

assembled of interleaved "L" shaped units. Other variations of the "shell type" now in use are the "EE" laminations and the "split-wound-loop" type, exemplified by the "Hypersil" design. Figure 21 shows outline drawings of the above types of cores.

The general design practice for small sine-wave power transformers is to use cores having a "stack" or "build" of a sufficient quantity of laminations to result in a square cross-section in the leg over which the windings are placed. This results in an economical use of the copper in the windings and provides a shape of winding form which is better adapted to automatic winding machines than the rectangular shape which would occur with a larger or smaller core "stack." Each size of lamination then receives a nominal power rating of so many watts, and the design usually starts from this point. Most small AC applications are not too greatly limited as to space or to efficiency considerations, and these standardizations in transformer size work out rather well.

In vibrator applications, however, there is usually a very different situation existing. The greatest demand is for minimum size and weight (and, as a corollary, minimum cost), with the best possible efficiency and life. The "power rating" conception of core sizes must be discarded if this is to be accomplished. Quite often it is necessary, or desirable, to design around a core having a radical rectangular cross-section in order to meet some dimensional requirement. Or, in order to reduce the leakage inductance of the unit, the use of a greater amount of iron and fewer turns than would normally be used is justified. Therefore, no fixed rules on core sizes can be given for use in various applications. The effects upon the vibrator performance and life should always be the major consideration. In general, the ideal conditions are obtained when the vibrator transformer is designed so the iron losses equal the copper losses.

Another core characteristic concerns the method of stacking the laminations to produce the desired core thickness. The common method of assembly is the insertion of the "E's" from alternate ends of the coil

and after all have been placed, to insert the "I's" in the vacant spaces between the ends of the "E's" so as to complete the magnetic circuit for each lamination through the butt-gap thus formed. The interleaving may be done singly, in groups of two, three, or four, but seldom in more than that number per group. The "I's" are tapped solidly into place and the core wedged, or clamped, to hold it tightly together until after impregnation. Often the clamps are left on the finished transformer.

The inductance of the windings and the necessary magnetization current are affected by the method of interleaving. With an assembly of laminations interleaved singly, the effective magnetic path will have the shortest length because of the reduction in the effective series air-gap in the core; thus, the magnetization current will be reduced to a minimum and the inductance will be made a maximum. The effects of stacking in groups of 2x2 is only slightly different from 1x1, while the change is much more pronounced with 3x3, or greater. A butt-joint introduces a definite air-gap into the magnetic circuit, and a resultant undesirable reduction in inductance. However, under certain unusual circumstances of operation, recent developments show that it is desirable to introduce a controlled small air gap condition. This is done to reduce the effects of steel saturation upon the required value of the timing capacitor when operating the transformer over a range of rather high values of flux-density. This will be covered and explained fully in a later chapter on Timing Capacitors.

Figure 22 is an illustration of the various methods of the interleaving the laminations and showing the resultant flux paths through the joints in the magnetic path. Illustrated are cores alternately interleaved in groups of one by one (1x1), two by two (2x2), three by three (3x3), and five by one (5x1). Regardless of the care exercised in the assembly of the laminations, the "I's" can never be made to join the open ends of the "E's" perfectly, and an air-gap results in the steel path. There are two joints in series in each path (see the dotted lines in Figure 21).

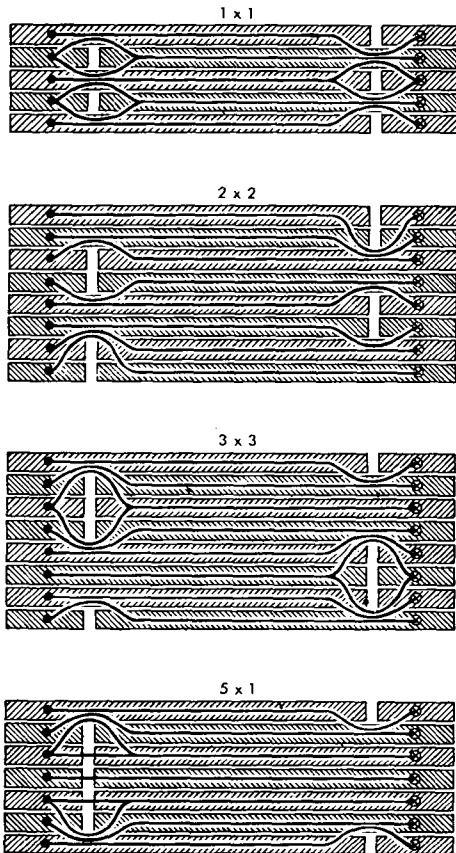

FIGURE 22

Because these air-gaps offer opposition to the flow of the magnetic flux, the latter will try to diverge and find a parallel path of lower reluctance in which to flow around the gaps. The bridging of the gap by an adjacent lamination furnishes such a parallel path of low reluctance. The air-gap between the parallel faces of the laminations is short when the assembly is clamped, usually being limited by oxide or finishes on the steel and by burrs occurring on the edges as a result of the punching process. The area of this air-gap is that of the parallel faces of the laminations, and obviously is much greater than that of the butt-joint cross-sectional area of the laminations. This combination of factors explains the low reluctance of the parallel path around the gap. Because the presence

of surface scale or oxide on the lamination affects the parallel air-gap length, it has been the usual practice to specify that the laminations be cleaned before annealing. This removes the objectionable surface condition and improves the "stacking factor." The "stacking factor" refers to the percentage of actual steel present in a given cross-section of a laminated core to the amount it would contain if the core were solid.

The presence of burrs on the edges of the laminations has the same effect as the scale on the surface and, therefore, is a detriment to the best construction and performance. The burrs also present sharp edges to adjacent laminations which undesirably provides a good electrical contact between the laminations and results in an increase in eddy-current losses. Therefore, the specifications should call for laminations that have been annealed following punching, which (1) reduces the height and sharpness of the burrs; (2) provides a very thin coating of oxide on the lamination surfaces which acts as an electrical insulator, thereby reducing the eddy-currents; (3) returns the magnetic characteristics of the steel to their original condition, thus assuring uniformity in the final assembly.

Good manufacturing practice provides that the lamination punching dies be constructed so that only very small burrs are produced. These dies should be resharpened whenever the burrs exceed certain maximum heights. Silicon steels are among the most difficult metals to punch satisfactorily. The dies should be inspected frequently since their life is comparatively short. Steels having higher silicon content are more difficult to punch. The recommendations of the steel manufacturer should be followed closely in the construction of punching dies and in specifying the burr limits.

Figure 22 shows that where there is an adjacent lamination bridging the butt-joint air-gap, the flux divides. Part of the flux crosses the air-gap and the remainder by-passes the air-gap by crossing into the adjacent lamination ahead of the joint and leaving it beyond the joint where the flux

returns to its original lamination. Since the adjacent lamination steel is already carrying its share of the flux, this additional by-passing flux crowded into this short portion of the magnetic circuit raises the flux-density considerably, thereby tending to saturate the steel in this section. These factors of air-gaps and spot saturation create intangibles which result in errors in subsequent calculations. About all that can be done in attaining greater accuracy is to control all of the factors as closely as possible in order to make the errors insignificant.

Interleaving the laminations 1x1 will place a bridging lamination on each side of the butt-joint air-gap. Interleaving 2x2 results in a bridging lamination on one side only of each air-gap, but experience has shown that this construction is more practical and gives almost the same results as the 1x1 stacking. However, with an interleaving of 3x3, or more, only the outside butt-joints are directly bridged by adjacent laminations, and the effect of the air-gap becomes much more pronounced in proportion to the number of unbridged joints in the assembly. The introduction of an air-gap requires a considerably higher magnetization current to produce the required flux-density, but straightens out the effective "B-H" curve of the combined steel air-path and overcomes some of the saturation effects. To accomplish this straightening to a complete degree requires a much longer air-gap than occurs under these interleaving methods.

During the recent years a new type of core construction has been developed which is based on the directional orientation of the steel molecules. When silicon steel sheets are rolled to secure the desired thickness, certain magnetic characteristics are imparted to the sheet because of the alignment or orientation of the grain structure during the process. When the "E" laminations are punched from this sheet, part of the magnetic path is along a portion of the steel in the direction of rolling and part of it is across the direction of rolling. It so happens that the permeability of the steel is much higher in the direction of the grain alignment than across this align-

ment and, therefore, the "E" lamination does not provide maximum permeability, or minimum reluctance, for the entire magnetic flux-path.

The "Hyper-sil" core is based on this orientation principle. The core is made by cutting a long ribbon of steel in the direction of rolling and grain alignment and winding upon a mandrel to form a compact core. The laminated assembly of wound ribbon is then impregnated with a high-temperature binder and baked to bind the laminations together. This core is then removed from the mandrel and cut into two parts, usually two open "C" cores. The faces of the cut sections are then ground smooth and parallel, and the two halves assembled through a pre-wound coil in the usual manner. Straps are fastened around the core, drawn snug and anchored, in a manner that holds parallel faces of the joints tightly together. The effective total air-gap of this arrangement is approximately .001 inches in length.

Because the flux-path is now entirely in the direction of the grain of the metal, the effective permeability of the core is much higher than for the usual laminated core. This means that the magnetization current for a given flux-density is lower. In addition, the losses in the core are reduced for a given flux-density and frequency, over those of the common laminated core, and the method of assembly lends itself very well to the use of very thin material. Therefore, the use of "Hyper-sil" core material would result in a transformer of smaller size than could be obtained with standard "E" and "I" laminations. This material may be used to advantage when size and weight are of prime importance.

## Core Steel Grades

The transformer core steel most often used in vibrator transformers are limited to four grades. These grades are usually designated by their specified core-loss characteristics as expressed in watts-per-pound, at a flux-density of 10,000 Gauss and 60 cycles-per-second frequency. The grades have also been identified by their silicon content, but this was not entirely satisfac-



tory since various grades may have the same silicon content and yet have different characteristics. 10,000 Gauss flux-density amounts to 10,000 lines per square centimeter, which is equivalent to 64,500 lines per square inch. The usual grades are listed below, with manufacturer's trade names for comparison:

MFGR.	TYPE I	TYPE II	TYPE III	TYPE IV
Allegheny-Ludlum Armco U.S. Steel	Dynamo Radio #2 Motor	Dynamo Special Radio #3 Dynamo	Trans- former C Radio #4 Trans- former 72	Trans- former A Radio #6 Trans- former 58
Thickness	CORE LOSS WATTS/LB.			
#29 Ga.	1.01	0.82	0.72	0.58
#26 Ga.	1.14	0.94	0.83	0.68
#24 Ga.	1.30	1.10	0.97	.....

The gauges listed above are for the thickness of the steel sheet used and are, in order, 0.014", 0.0188", and 0.025" thick respectively. As a general rule, only Types III and IV are used in #29 gauge. I, II and III are used in #26 gauge, and I and II in #24 gauge sizes. The cost of the material or laminations plus the assembly labor versus the savings in core losses, etc., will determine to a large extent which grade and gauge of steel is used. It has been a more or less general practice to use #24 gauge of Types I or II for the medium or high-powered 115 cycle vibrator applications. On low output 115 cycle applications, where high efficiency or other factors warrant it, #26 or #29 gauge Types III or IV are often used. For higher frequency vibrators, Types III or IV in #29 gauge are necessary.

Typical curves, as furnished by the Allegheny-Ludlum Steel Corporation, are included in this text for the purpose of providing reliable technical information for use in making calculations as described in a following chapter. "B-H" curves for each of the types of steel listed in the preceding paragraphs, as well as curves showing the variation of core-loss characteristics of each grade with frequency and flux-density, are included in Figures 27 to 33 inclusive. Additional sets of curves (Figures 34 and 35) have been calculated and plotted

from information provided by the Allegheny-Ludlum Steel Company. These show the variation in core-loss coefficients for the various grades, so that the approximate core-loss for any actual frequency and flux-density involved in the design can be calculated. This data is valuable when making comparisons of optional designs so as to secure the lowest over-all loss characteristics of core-loss, copper-loss, and magnetizing current.

## Leakage Inductance

Magnetic leakage in a transformer is still another factor which must be considered with regard to its effect upon vibrator operation. This factor has some detrimental effects upon sine-wave AC transformers, such as increasing the regulation of power transformers and impairing the frequency characteristics of audio-frequency amplifier transformers. However, in vibrator transformers magnetic leakage is particularly serious. In effect, it introduces into the primary circuit an inductive reactance through which the load-current passes and in which induced transients occur when the vibrator contacts break this load-current. These transient voltages create arcs across the contact interfaces at the "break" and naturally have some destructive effect upon the performance and life of the contacts. When the timing capacitor is in the secondary circuit this leakage inductance interposed between the secondary circuit and the primary prevents the perfect reflection of the timing capacitance into the primary circuit. The larger values of leakage inductance reduces the magnetic coupling and the effectiveness of the timing capacitor. This same condition aids the creation of spurious damped oscillations during both the "on-contact" and "off-contact" periods of the vibrator. These oscillations have varying frequencies and amplitudes, and may be difficult to eliminate.

Leakage inductance results from imperfect coupling between the primary and the secondary, or secondaries, of the transformer. This lack of coupling results primarily from the mechanical arrangement

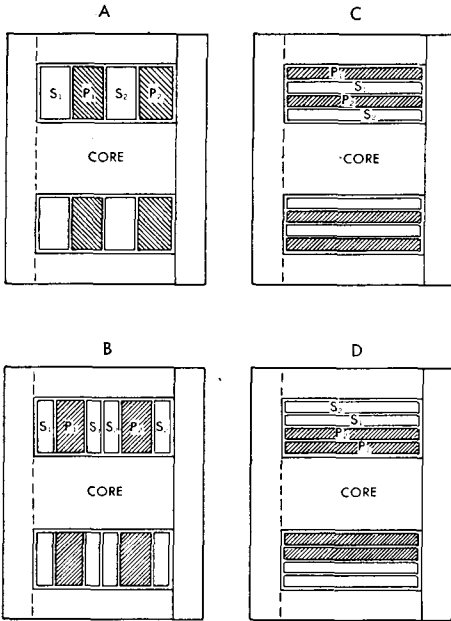

FIGURE 23

of the coils, the relative number of turns employed, and the spacing of the coils with respect to each other. The fact that most vibrator transformers utilize both a center-tapped primary and secondary results in a considerable amount of leakage. Only one half of the primary and one half of the secondary carry load current at any point in the cycle. The other two sections of the windings act somewhat as space-occupying elements, which may separate the active windings and thus reduce their effective coupling. By employing the proper subdivision of the primary and secondary windings into individual coils, and by so arranging them mechanically and interconnecting them electrically so as to secure the closest coupling between the active coils, the leakage inductance can be held to a minimum for a given design. This method is comparatively expensive and slow for mass-produced units and is seldom used. The usual method of layer-winding of both secondaries and both primaries in sequence lends itself readily to mass production on automatic winding machines and to low production costs.

This method involves higher leakage inductance values, and an unbalance in the amount of leakage existing between the two halves of the cycle. Transformer designs having comparatively large cross-sectional areas of core and a small number of primary turns will have a lower value of leakage inductance than designs using a comparatively small core area and a large number of primary turns.

The two methods just described are illustrated in Figure 23. Illustrations "A" and "B" show the method of winding and assembly of the coils in individual "pies" so as to obtain the maximum coupling between the active coils. The connections to the coils can be so phased that the output voltage polarity, either with a self-rectifying vibrator or with a tube rectifier, will be as desired when using the closely coupled coils. Illustration "A" shows the simpler of the two arrangements, but this would not result in quite as low a leakage reactance as would "B," where the secondary is split and placed on either side of the primary.

Illustration "C" shows an arrangement of layer-wound coils where the primary and secondary sections are interleaved so as to secure close spacings and coupling between the active coils. This method requires that the electrical connections be properly phased in order to secure this close coupling, and thus all end-taps from the coils must be brought out from the transformer for external connection. Illustration "D" shows the usual method of manufacturing commercial vibrator transformer coils. Primary P-2 is a continuation of primary coil P-1, except that the start of the former is connected to the finish of the latter and often brought out as a single connection. The secondary sections are wound in a similar manner. This makes for the most economical coil winding arrangement, when layer-wound coils are being considered.

While leakage inductance can be calculated from the known physical dimensions and winding data, it is usually desirable to actually measure this characteristic from a sample of the production transformer. Since the total effective leakage induct

ance is the figure affecting the performance of the vibrator, this can best be determined from the primary side of the transformer. The test can be made by short-circuiting the secondary winding and measuring the resulting primary inductance on an AC bridge. Since a perfect transformer would reflect the short-circuit directly across the primary, the lack of perfect coupling is reflected by the inductance measured when the short-circuit is present across the opposite winding.

It may be of design interest to measure the leakage inductance between the active halves of the two windings, rather than between the entire windings. This emphasizes the amount of the unbalance which affects the two halves of the operating cycle. This test is made in the same manner, the short-circuit being placed across one active winding and the inductance measured across the other. If the measuring equipment requires that the measurement be made across the secondary, with the primary short-circuited, in order to use values that fall within the equipment range, this can easily be converted into primary values. The primary value is related directly to the secondary value by the square of the transformer turn-ratio.

$$\text{Thus } L_p = \frac{L_s}{a^2} \text{ where } a = \frac{N_2}{N_1}$$

## Coil Construction

It is a universal practice to wind the coils without bobbin support, using an inner-tube support wound from heavy Kraft paper and cemented together. Kraft or glassine paper is used between layers for layer insulation. The thickness of the paper depends upon the size of wire and upon the electrical barrier insulation needed. The type of insulation used on the wire is a plain enamel in practically all instances. Occasionally, heavy or double enamel is used for special applications. A table, Figure 24, lists the usual permissible turns of enameled round copper magnet wire that can be wound per linear-inch of paper-layer coils for each size of wire. A guide to the thickness and type of paper

inter-layer insulation commonly employed with the various sizes of wire is also listed. This table can be used as a guide for calculating copper requirements in various designs of reactor, solenoid, and relay coils. The same table shows the resistance of the various wire sizes listed by ohms per 1000 ft. of wire, so that by figuring the mean-length-of-turn for a coil, the resistance can be approximated.

Another table is furnished, Figure 25, in which the lamination type numbers and essential dimensions for the most commonly used small laminations adapted for vibrator use are given. A third table, which will probably be most useful, is given in Figure 26. This represents the present commercial winding information for various sizes of enameled-copper round magnet wire for the various lamination sizes, and is an excellent time-saver. The laminations listed are not all that are available, but are representative of those commonly used.

Complete data in the form of pamphlets or books are usually available from the various magnetic steel manufacturers upon request. It is suggested that steel manufacturer's representatives be contacted for additional information other than that included in this text.

No exact correlation has been attempted between the winding data furnished in the table of Figure 24 and that listed in the table of Figure 26. As noted on the tables, the sources of the information are different and one is a theoretical compilation while the other is the result of a practical commercial application of experimental and shop experience. The winding information relates particularly to automatic winding machines. It should be noted that in several cases, a number of laminations have the same coil and winding lengths, and thus the same winding data. The difference lies, of course, in the other dimensions of the lamination, such as width of window, center-leg, etc.

In addition to the foregoing, there are a number of other factors which have to be taken into consideration in designing transformers. These factors have been dictated by standard commercial practice in pro-

ducing low-cost transformers in high-volume production. They have been considered in making the sample transformer designs included in this book, and a brief statement of each follows.

Through a number of years of experience in designing vibrator transformers, it has been found, with minor exceptions, that the most economical and practical use of winding space will result in the use of three layers of wire for the primary winding. Inasmuch as the primary winding of a vibrator transformer is center-tapped, this results in the necessity of bringing the center-tap out from the middle of a layer. The most common practice encountered in bringing this center-tap out from the middle of the layer is to lay in a tab of conductive material and fasten a flexible lead to this tab on the outside of the coil. Since some space is necessary for this tab to be laid in, it is common practice not to use the full number of turns which could have been wound on the tapped layer. In addition to this factor and to aid in producing transformers at low cost, the transformer companies make a practice of cutting the wire off even with the coil when the transformer is wound, and then bring the leads out for the start and finish of the winding by taking one turn off both the start and finish layers. As a result of this practice, a good design will allow approximately one turn per layer for the start and finish leads and the center-tap so that in

effect the number of turns which can be placed in a primary layer is one less than shown in the table.

Current transformer manufacturing practices utilize machine winding for all secondaries. In order to bring out a center tap from the secondary winding, the transformer manufacturers have resorted to the practice of completely machine winding the secondary and then reaching in the winding with a pair of tweezers and pulling off one marked turn at the exact center of the coil, which produces the center tap. As a result, it is necessary to design the transformers so the secondary is in even-numbered layers. This will make the electrical center of the coil on the edge. For example, the number of turns required for the secondary winding should be calculated and divided by the number of turns which can be placed in one layer. If the number of layers required comes out to an odd figure, it will be necessary to reduce the number of turns per layer to make the layers come out an even number. The total secondary coil build can be calculated from this information.

The final factor which will influence the transformer design is the core-stacking factor. In actual practice this factor has been found to be between the limits of .88 to .95, or 88% to 95%. For the purpose of most design work, it will be found that a value of .91 or .92 will represent a satisfactory value for commercial practice.

# Tables, Charts, Graphs and Formulas

Wire Size	Overall Diameter			N/Inch	End Margin	Interlayer Paper	Ohms/1000' Nom. Dia.	X-Section Cir. Mils.	Wire Size
	Min.	Nom.	Max.						
10	.1024	.1039	.1054	9	.2500	.010 Kr.	.999	10,380.	10
11	.0913	.0927	.0941	10	.2500	.010 Kr.	1.260	8,226.	11
12	.0814	.0827	.0840	11	.2500	.010 Kr.	1.588	6,529.	12
13	.0726	.0739	.0750	12	.2500	.010 Kr.	2.003	5,184.	13
14	.0648	.0660	.0670	13½	.2500	.010 Kr.	2.525	4,109.	14
15	.0578	.0589	.0598	15	.2500	.010 Kr.	3.184	3,260.	15
16	.0515	.0525	.0534	17	.1875	.007 Kr.	4.016	2,580.	16
17	.0460	.0469	.0477	19	.1875	.007 Kr.	5.064	2,052.	17
18	.0410	.0418	.0426	21	.1875	.007 Kr.	6.385	1,624.	18
19	.0366	.0374	.0382	24	.1562	.005 Kr.	8.051	1,289.	19
20	.0326	.0334	.0341	26	.1562	.005 Kr.	10.15	1,024.	20
21	.0292	.0299	.0305	30	.1562	.005 Kr.	12.80	812.	21
22	.0261	.0266	.0273	34	.1250	.003 Kr.	16.14	640.	22
23	.0232	.0239	.0244	39	.1250	.003 Kr.	20.36	511.	23
24	.0208	.0213	.0218	43	.1250	.002 Gl.	25.67	404.	24
25	.0186	.0190	.0195	48	.1250	.002 Gl.	32.37	320.	25
26	.0166	.0170	.0174	54	.1250	.002 Gl.	40.81	253.	26
27	.0148	.0152	.0156	60	.1250	.0015 Gl.	51.47	201.6	27
28	.0132	.0136	.0140	67	.1250	.0015 Gl.	64.90	158.8	28
29	.0118	.0122	.0126	75	.1250	.0015 Gl.	81.83	127.7	29
30	.0105	.0109	.0112	84	.1250	.0015 Gl.	103.2	100.00	30
31	.0094	.0097	.0100	94	.1250	.0015 Gl.	130.1	79.21	31
32	.0085	.0088	.0091	104	.0937	.0015 Gl.	164.1	64.00	32
33	.0075	.0078	.0081	117	.0937	.0015 Gl.	206.9	50.41	33
34	.0067	.0069	.0072	131	.0937	.0010 Gl.	260.9	39.69	34
35	.0059	.0062	.0064	146	.0937	.0010 Gl.	329.0	31.36	35
36	.0053	.0055	.0058	162	.0937	.0010 Gl.	414.8	25.00	36
37	.0047	.0050	.0052	183	.0937	.0010 Gl.	523.1	20.25	37
38	.0042	.0044	.0047	204	.0625	.0010 Gl.	659.6	16.00	38
39	.0036	.0039	.0041	227	.0625	.0007 Gl.	831.8	12.25	39
40	.0032	.0034	.0037	261	.0625	.0007 Gl.	1049.0	9.61	40
41	.0029	.0031	.0033	296	.0625	.0007 Gl.	1323.0	7.84	41
42	.0026	.0028	.0030	326	.0625	.0007 Gl.	1669.0	6.25	42

"End Margin" is the paper margin required at each end of the coil.

"Kr." is Kraft paper; "Gl." is Glassine paper.

"X-Section" is the cross-sectional area of the nominal copper diameter.

FIGURE 24—Turns per Inch Permissible in Paper-Layer Coils  
for Plain Enamel Round Copper Magnet Wire

Lamination No.	Center-Leg	Window		Overall		"F"	Length Mag. Path	Pounds per Inch Stack
	"A"	"B"	"C"	"D"	"E"			
EE-24/25	0.250	.250	0.500	1.000	0.750	.125	2.00	0.128
EE-26/27	0.375	.250	0.687	1.250	1.062	.187	2.63	0.250
EE-17/18	0.578	.578	1.046	2.312	1.624	.289	4.40	0.650
#X000	0.490	.320	1.125	1.630	1.625	.250	3.89	0.488
EI-50/K000	0.500	.250	0.750	1.500	1.250	.250	3.00	0.376
EI-21/H000	0.500	.312	0.812	1.625	1.312	.250	3.25	0.411
EI-625/F000	0.625	.312	0.937	1.875	1.562	.312	3.75	0.598
EI-75/D000	0.750	.375	1.125	2.250	1.875	.375	4.50	0.857
EI-11/B000	0.875	.437	1.312	2.625	2.187	.437	5.26	1.160
EI-12/1000	1.000	.500	1.500	3.000	2.500	.500	6.00	1.520
EI-112/13000	1.125	.562	1.687	3.375	2.812	.562	6.75	1.930
EI-125/14000	1.250	.625	1.875	3.750	3.125	.625	7.50	2.380

Holes located at the corners, or in the center of the long sides, of the Laminations are usually available for clamping or mounting of the core assembly except on the smallest sizes. Check with the transformer supplies for the type available.

"EE" and "EI" numbers given are the designations of the Allegheny-Ludlum Steel Corp.; #X000, etc., numbers are the designations of the Chicago Transformer Corp., Division of Essex Wire Corp. Similar numbers are used by other suppliers.

FIGURE 25—Table of Dimensions for Common Types of Laminations

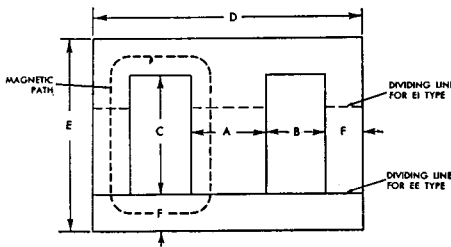

FIGURE 25

## Design Formulae

### FLUX DENSITY

$$\left( \begin{array}{l} \text{Vibrator} \\ \text{Square-Wave} \end{array} \right) B = \frac{E_1 \times \omega_t \times 10^8}{4 \times f \times N_1 \times A \times K_c}$$

Lines per Square Inch

$$\left( \begin{array}{l} \text{AC} \\ \text{Sine-Wave} \end{array} \right) B = \frac{E_1 \times 10^8}{4.44 \times f \times N_1 \times A \times K_c}$$

Lines per Square Inch

Where:

B = Flux density (lines per square inch)

$E_1$  = Applied input voltage (volts)

f = Frequency (cycles/sec.)

$N_1$  = Active primary turns

A = Apparent cross-sectional core area (sq.in.)

$K_c$  = Core stacking factor (approx. 0.91)

$\omega_t$  = Vibrator time efficiency (in decimals)

### PRIMARY TURNS PER VOLT

$$\left( \begin{array}{l} \text{Vibrator} \\ \text{Square-Wave} \end{array} \right) \frac{N_1}{E_1} = \frac{\omega_t \times 10^8}{4 \times f \times A \times K_c \times B} = \text{Turns/volt}$$

### CORE LOSSES

(For #29 Ga.) Watts per Pound =  
( $e \times f^2$ ) + ( $h \times f$ )

(For other Ga.) Watts per Pound =  
( $5100 t^2 \times f^2 \times e$ ) + ( $h \times f$ )

Where:

e = Eddy-current coefficient

h = Hysteresis coefficient

f = Frequency (cycles/sec.)

t = Lamination thickness (inches)

WATTS PER POUND (For 2 frequencies and for 3 gauges of sheet):

Gauge:	115 CYCLES	250 CYCLES
#24	$4.22 \times 10^4 e + 115h$	$20.0 \times 10^4 e + 250h$
#26	$2.36 \times 10^4 e + 115h$	$11.2 \times 10^4 e + 250h$
#29	$1.322 \times 10^4 e + 115h$	$6.25 \times 10^4 e + 250h$

### PEAK MAGNETIZING CURRENT

$$\frac{i_m}{N_1} = \frac{H \times l}{N_1}$$

Where:

H = Value from B-H curve

l = Length of magnetic path

$N_1$  = Active primary turns

FIGURE 27a—Frequency—Core Loss Characteristics  
 English Units—#24 U.S.S. Gauge (.025")  
 Allegheny Dynamo Grade Steel Sheets

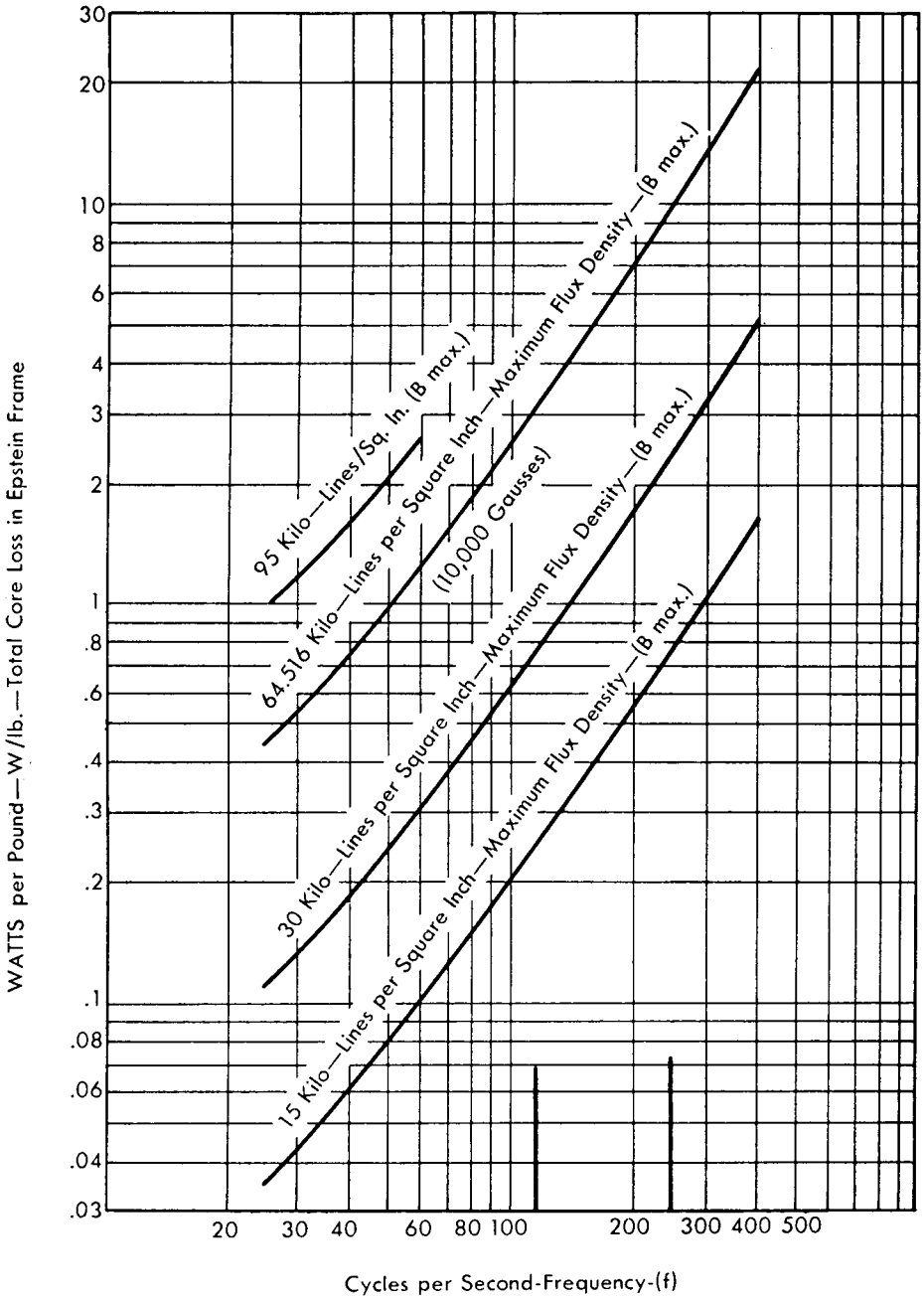

Wire Size No.	Maximum Diam. Inches	Average Area C.M.	Ohms per 1000 Feet	Inter-Layer Paper	E-E 17-18	EI-50 #K000	EI-21 #H000	EI-625 #F000	Wire Size No.
10	.1050	10400	0.999	.010 Kr.	.....	.....	.....	.....	10
11	.0936	8230	1.260	.010 Kr.	.....	.....	.....	.....	11
12	.0836	6530	1.588	.010 Kr.	.....	.....	.....	8	12
13	.0747	5180	2.003	.010 Kr.	10	.....	7	9	13
14	.0667	4110	2.525	.010 Kr.	11	7	8	10	14
15	.0596	3260	3.184	.007 Kr.	12	7	9	11	15
16	.0531	2580	4.016	.007 Kr.	14	8	10	12	16
17	.0475	2060	5.064	.007 Kr.	15	9	11	14	17
18	.0424	1620	6.385	.005 Kr.	17	11	12	15	18
19	.0379	1290	8.051	.005 Kr.	19	12	13	17	19
20	.0340	1020	10.15	.005 Kr.	21	13	15	19	20
21	.0303	812	12.80	.004 Kr.	24	15	16	22	21
22	.0270	640	16.14	.004 Kr.	27	17	19	24	22
23	.0243	511	20.36	.003 Kr.	30	19	21	27	23
24	.0217	404	25.67	.003 Kr.	34	21	24	30	24
25	.0194	320	32.37	.003 Kr.	38	24	27	34	25
26	.0173	253	40.81	.003 Kr.	43	27	30	38	26
27	.0154	202	51.47	.0015 Gl.	48	30	33	42	27
28	.0137	159	64.90	.0015 Gl.	54	34	37	48	28
29	.0124	128	81.83	.0015 Gl.	60	37	42	53	29
30	.0110	100.0	103.2	.0015 Gl.	67	42	47	60	30
31	.0099	79.2	130.1	.0015 Gl.	75	47	53	67	31
32	.0089	64.0	164.1	.0015 Gl.	83	52	58	74	32
33	.0079	50.4	206.9	.0015 Gl.	94	59	67	85	33
34	.0071	39.7	260.9	.0015 Gl.	105	66	74	94	34
35	.0063	31.4	329.0	.001 Gl.	118	74	82	105	35
36	.0057	25.0	414.8	.001 Gl.	132	82	94	119	36
37	.0052	20.3	523.1	.001 Gl.	147	90	104	132	37
38	.0047	16.0	659.6	.001 Gl.	163	100	114	145	38
39	.0041	12.3	831.8	.001 Gl.	185	114	132	167	39
40	.0037	9.6	1049.0	.00075 Gl.	207	128	146	186	40
41	.0033	7.8	1323.0	.00075 Gl.	234	142	162	207	41
Center-Leg Width.....					.578"	.500"	.500"	.625"	
Window Length.....					1.046"	.750"	.812"	.938"	
Coil Length.....					1.035"	.740"	.800"	.920"	
Winding Length.....					.785"	.490"	.600"	.700"	
Window Width.....					.578"	.250"	.312"	.312"	
Core-Tube Thickness.....					.035"	.035"	.035"	.035"	
Coil Build (Max.)—Wire and Paper Only.....					.470"	.165"	.220"	.220"	

FIGURE 26—Maximum Turns per Layer for Various Sizes of Laminations

Transformer BH Curves  
 Courtesy Allegheny Ludlum Steel Corporation



Wire Size No.	#X000	EI-75 #D000	EI-11 #B000	EI-12 #1000	EI-112 #13000	EI-125 #14000	Wire Size No.
10	.....	.....	8	10	12	14	10
11	8	8	10	11	14	15	11
12	9	9	11	12	15	17	12
13	11	11	13	14	17	19	13
14	12	12	14	15	19	21	14
15	13	13	16	17	22	24	15
16	15	15	18	19	24	27	16
17	17	17	20	23	27	30	17
18	18	18	22	25	30	34	18
19	21	21	25	28	34	38	19
20	23	23	28	31	38	42	20
21	26	26	31	36	42	47	21
22	29	29	35	40	47	52	22
23	32	32	39	44	53	59	23
24	37	37	43	50	58	65	24
25	41	41	49	56	66	73	25
26	46	46	55	63	74	82	26
27	52	52	61	69	83	90	27
28	58	58	68	78	92	102	28
29	65	65	76	88	103	114	29
30	73	73	86	98	116	128	30
31	81	82	96	110	130	144	31
32	90	90	106	122	143	159	32
33	102	104	122	140	165	183	33
34	114	114	134	155	181	202	34
35	128	127	150	172	202	225	35
36	144	145	170	196	230	256	36
37	161	161	189	217	255	284	37
38	176	176	207	238	280	311	38
39	202	204	240	275	323	359	39
40	226	226	265	305	358	398	40
41	251	251	296	340	399	444	41
	.490"	.750"	.875"	1.00"	1.125"	1.25"	
	1.125"	1.125"	1.312"	1.50"	1.688"	1.875"	
	1.12"	1.12"	1.30"	1.47"	1.65"	1.844"	
	.085"	0.90"	1.00"	1.15"	1.35"	1.50"	
	.320"	.375"	.437"	.500"	.562"	.625"	
	.035"	.050"	.050"	.050"	.050"	.050"	
	.225"	.260"	.300"	.350"	.410"	.460"	

NOTE: The above data represents commercial practice, as derived from information furnished by the Chicago Transformer Corp.

FIGURE 27b—Frequency—Core Loss Characteristics  
 English Units—#29 U.S.S. Gauge (.014")  
 Allegheny Transformer "A" Grade Steel Sheets

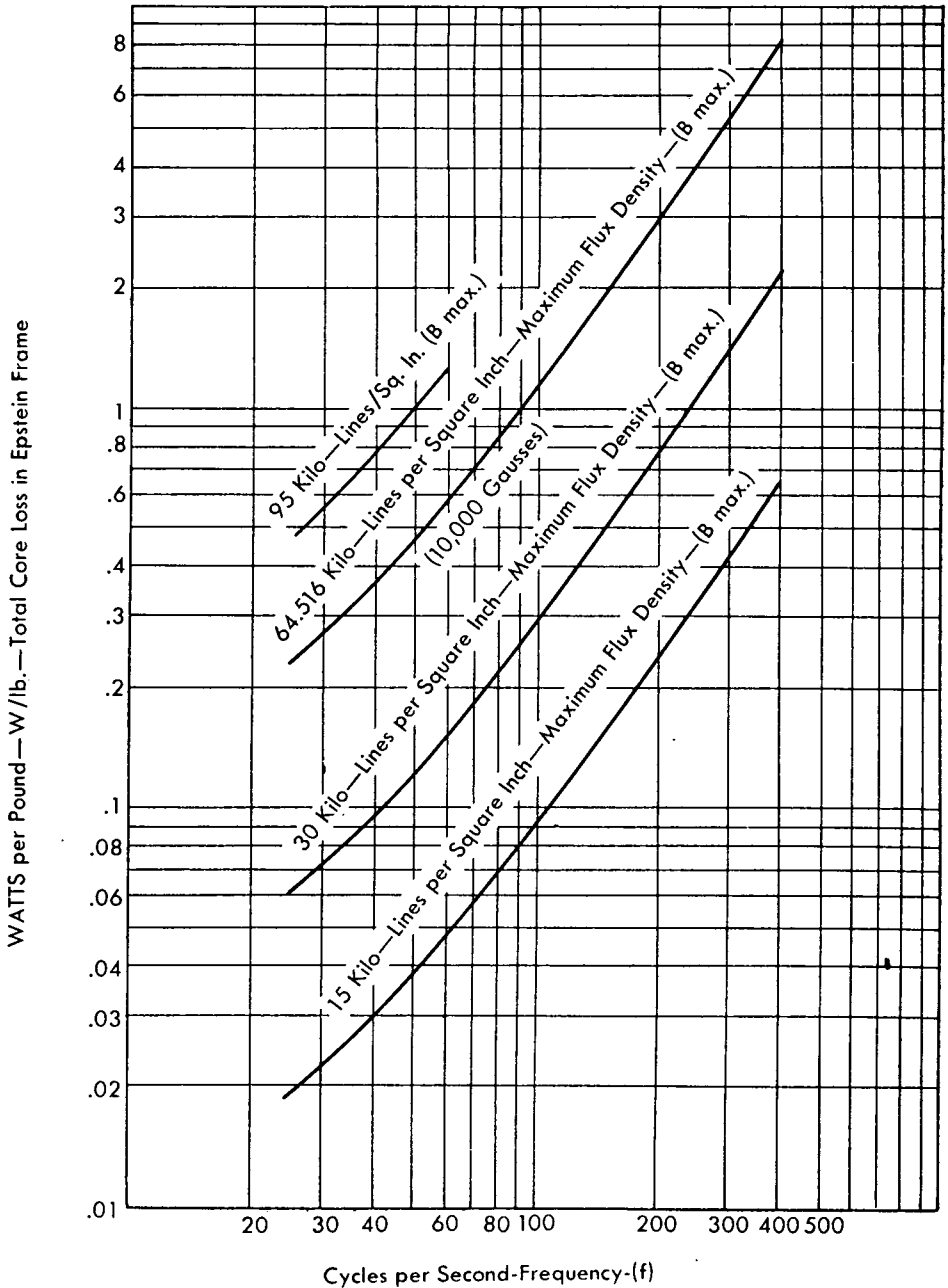

FIGURE 28—Frequency—Core Loss Characteristics  
 English Units—#29 U.S.S. Gauge (.014")  
 Allegheny Transformer "C" Grade Steel Sheets

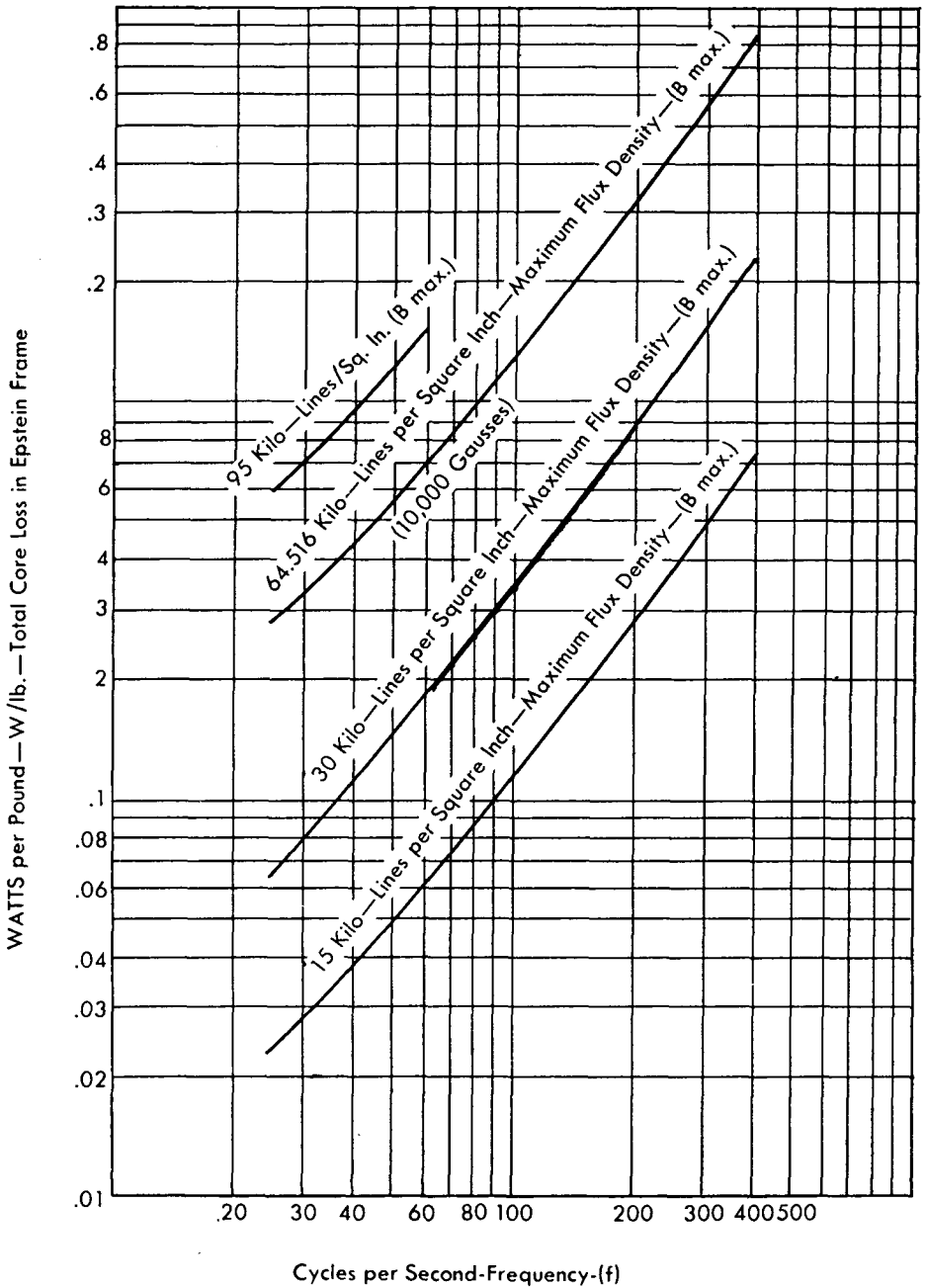

FIGURE 29—Frequency—Core Loss Characteristics  
 English Units—#29 U.S.S. Gauge (.014")  
 Allegheny Dynamo Special Grade Steel Sheets

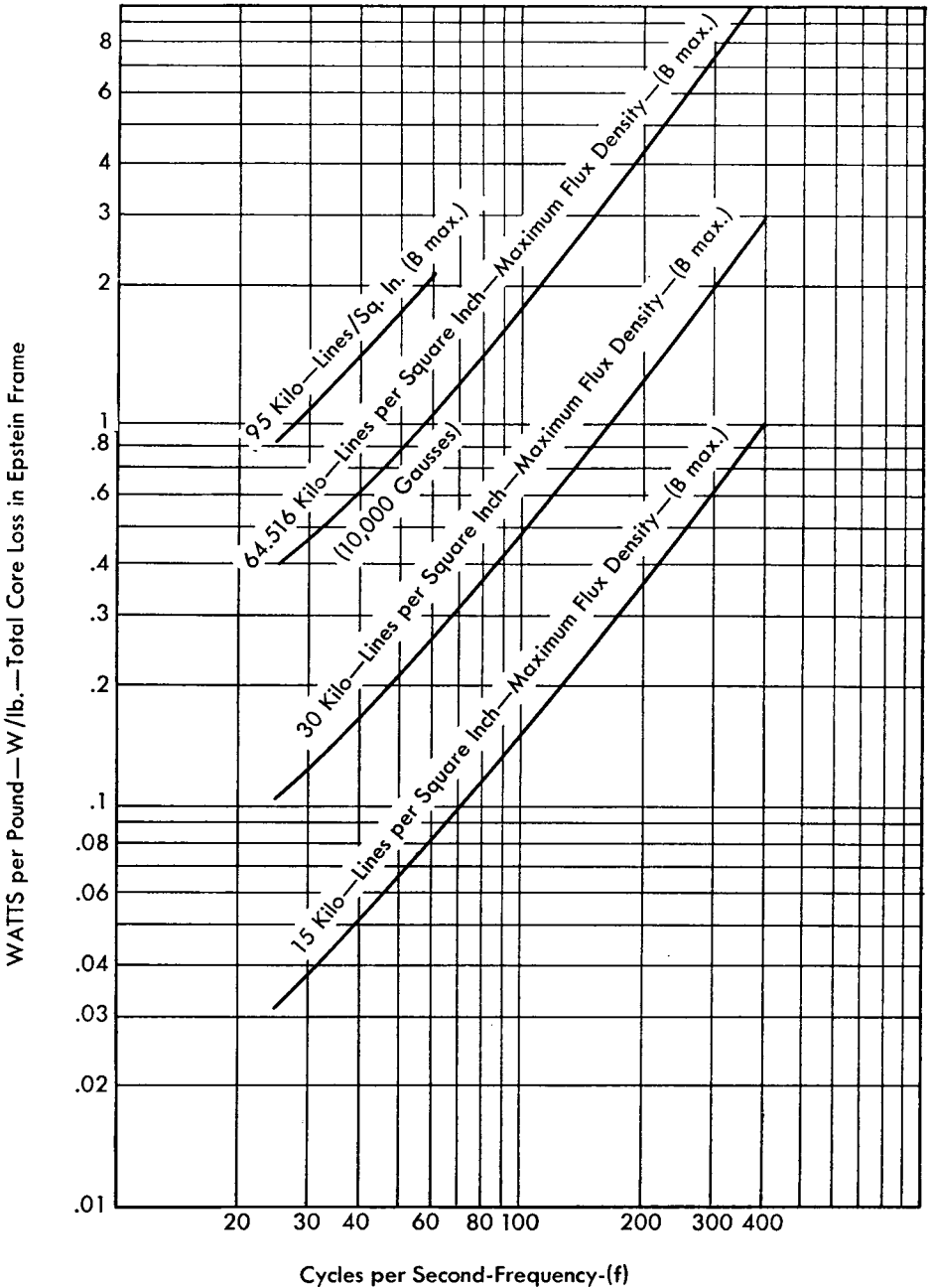

FIGURE 30—Frequency—Core Loss Characteristics  
 English Units—#29 U.S.S. Gauge (.014")  
 Allegheny Dynamo Grade Steel Sheets

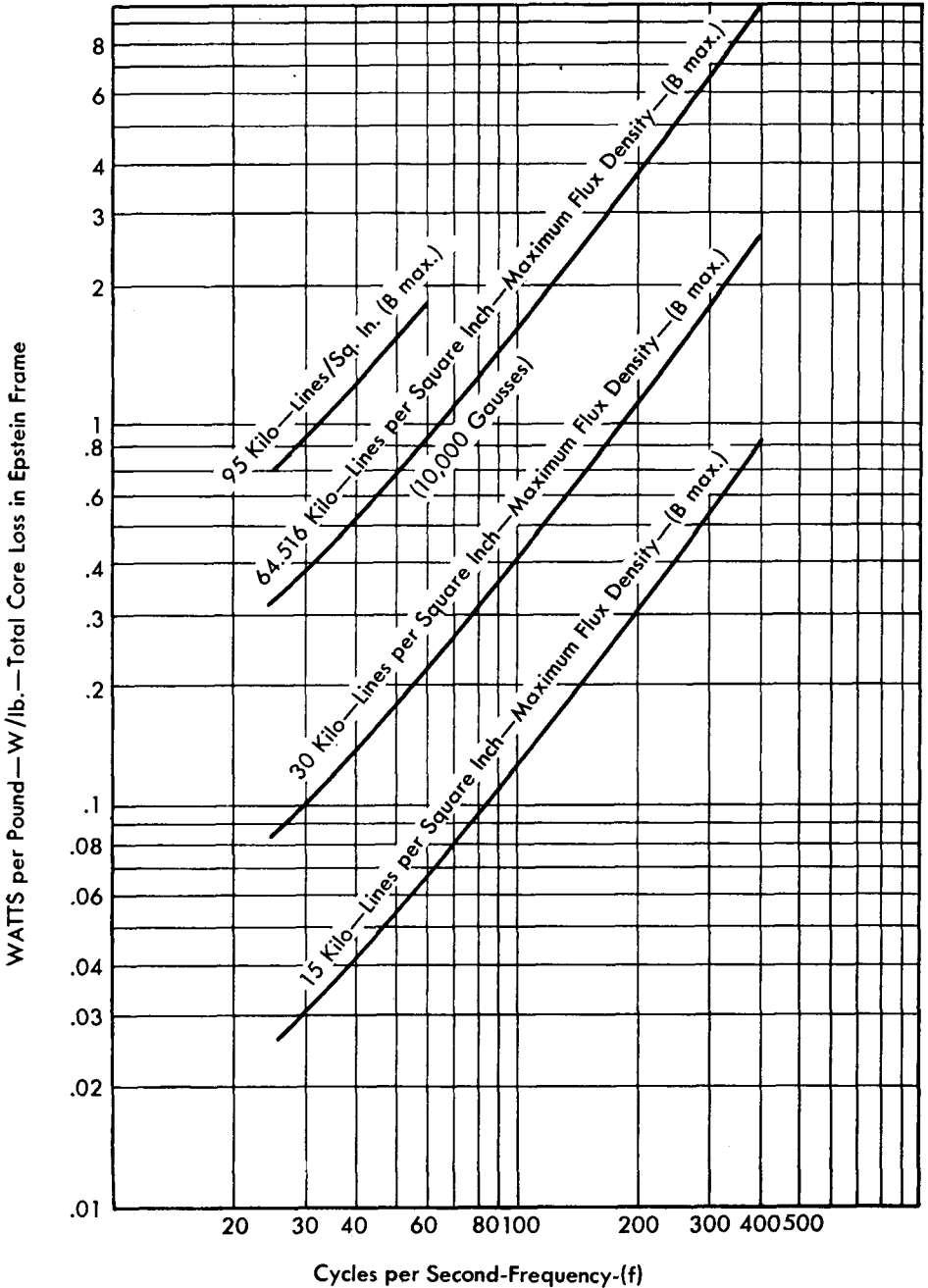
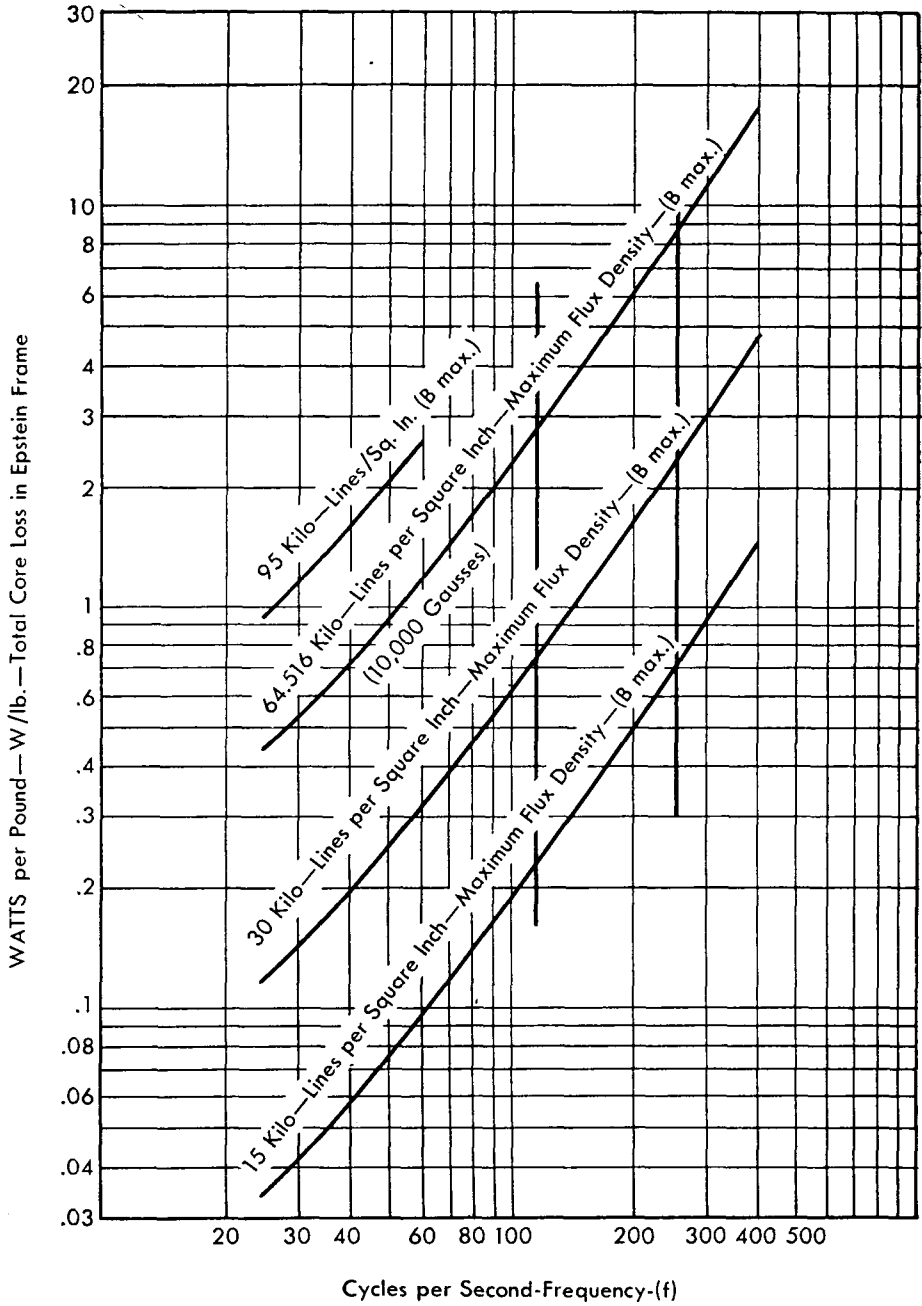

FIGURE 31—Frequency—Core Loss Characteristics  
English Units—#26 U.S.S. Gauge (.019")  
Allegheny Dynamo Grade Steel Sheets



**FIGURE 32—Performance Range D.C. Magnetization Permeability Curves  
Allegheny Transformer "C" Grade Steel Sheets  
(English Units)**

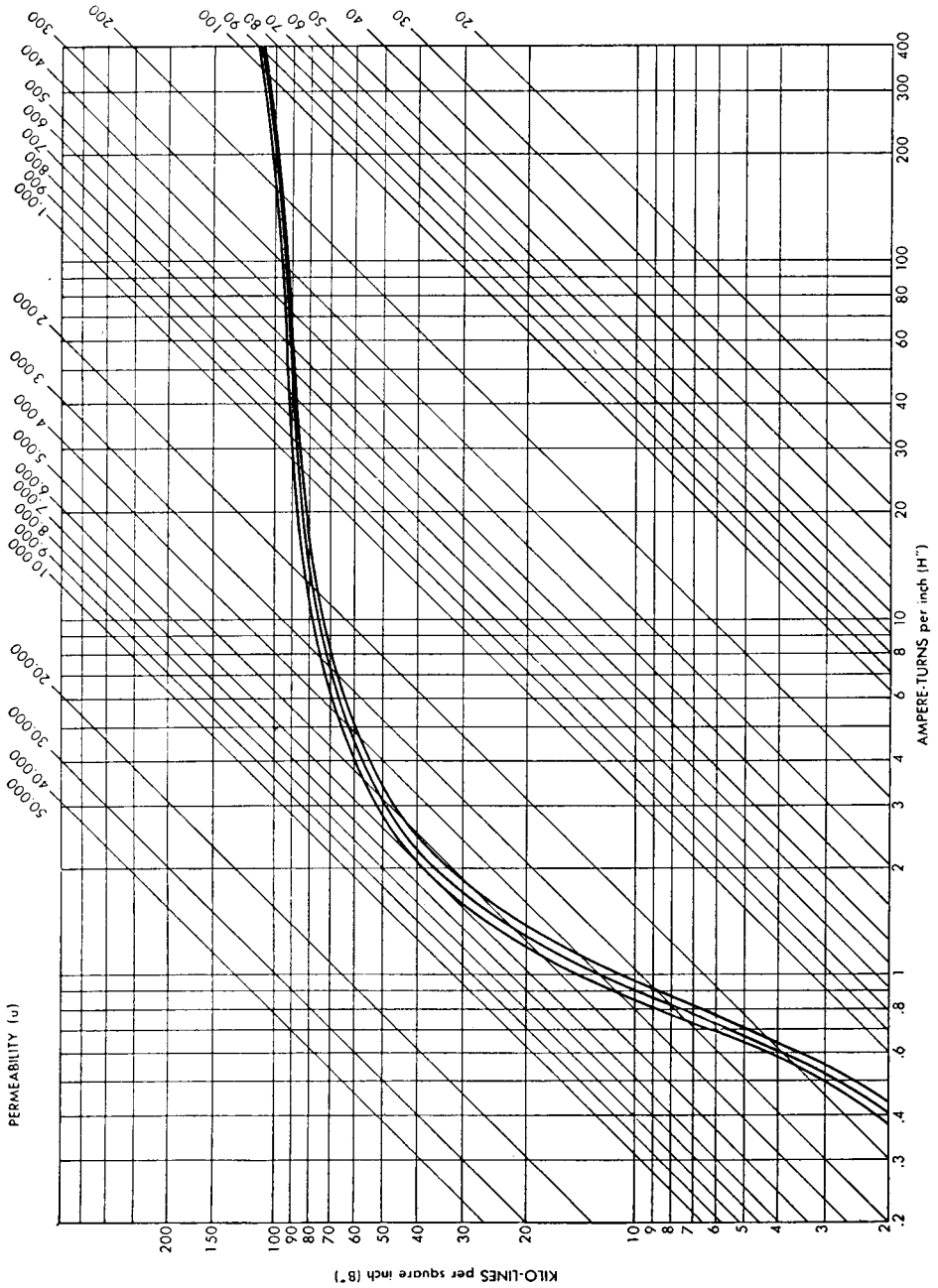

FIGURE 33—Performance Range D.C. Magnetization Permeability Curves  
 Allegheny Dynamo Special Grade Steel Sheets  
 (English Units)

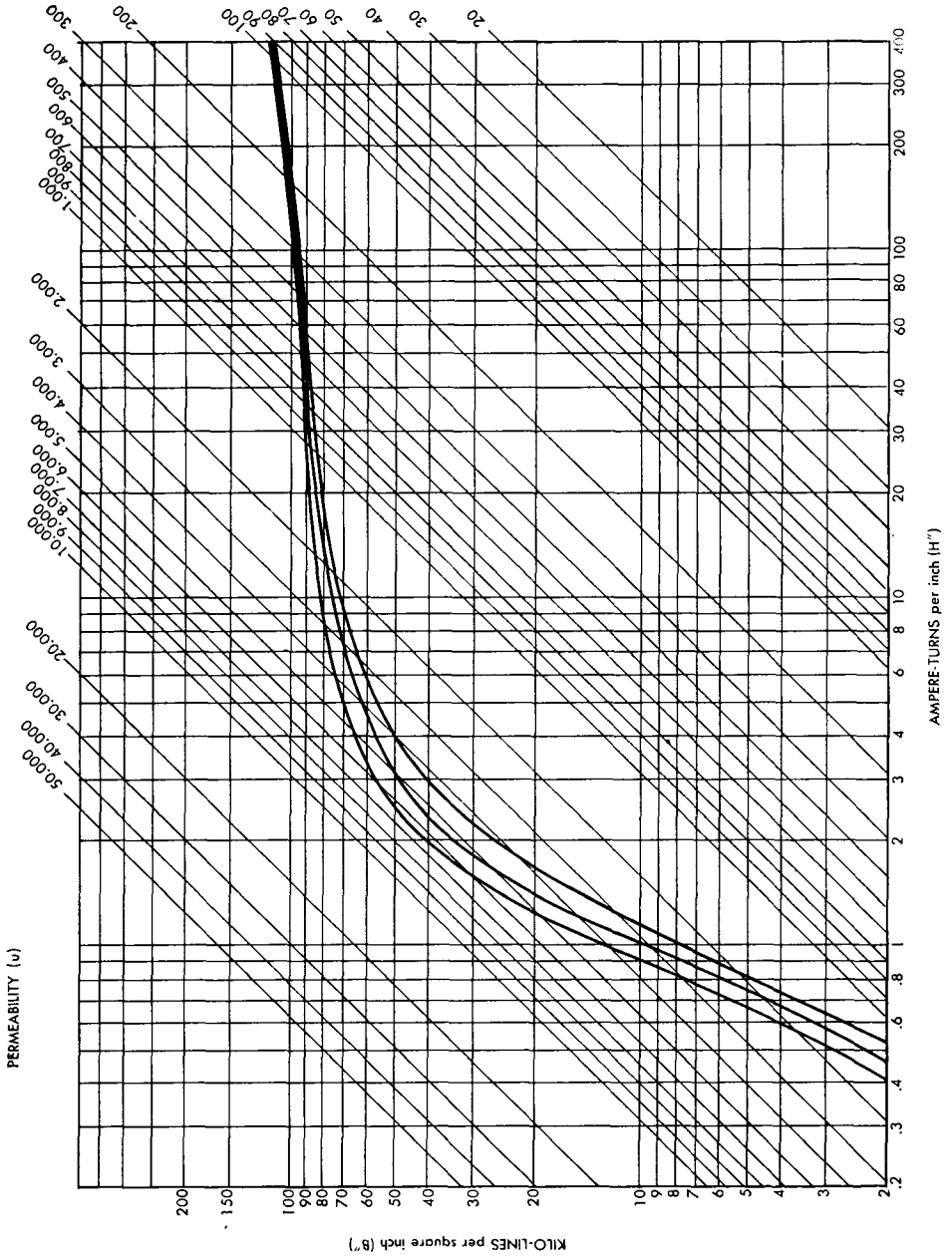
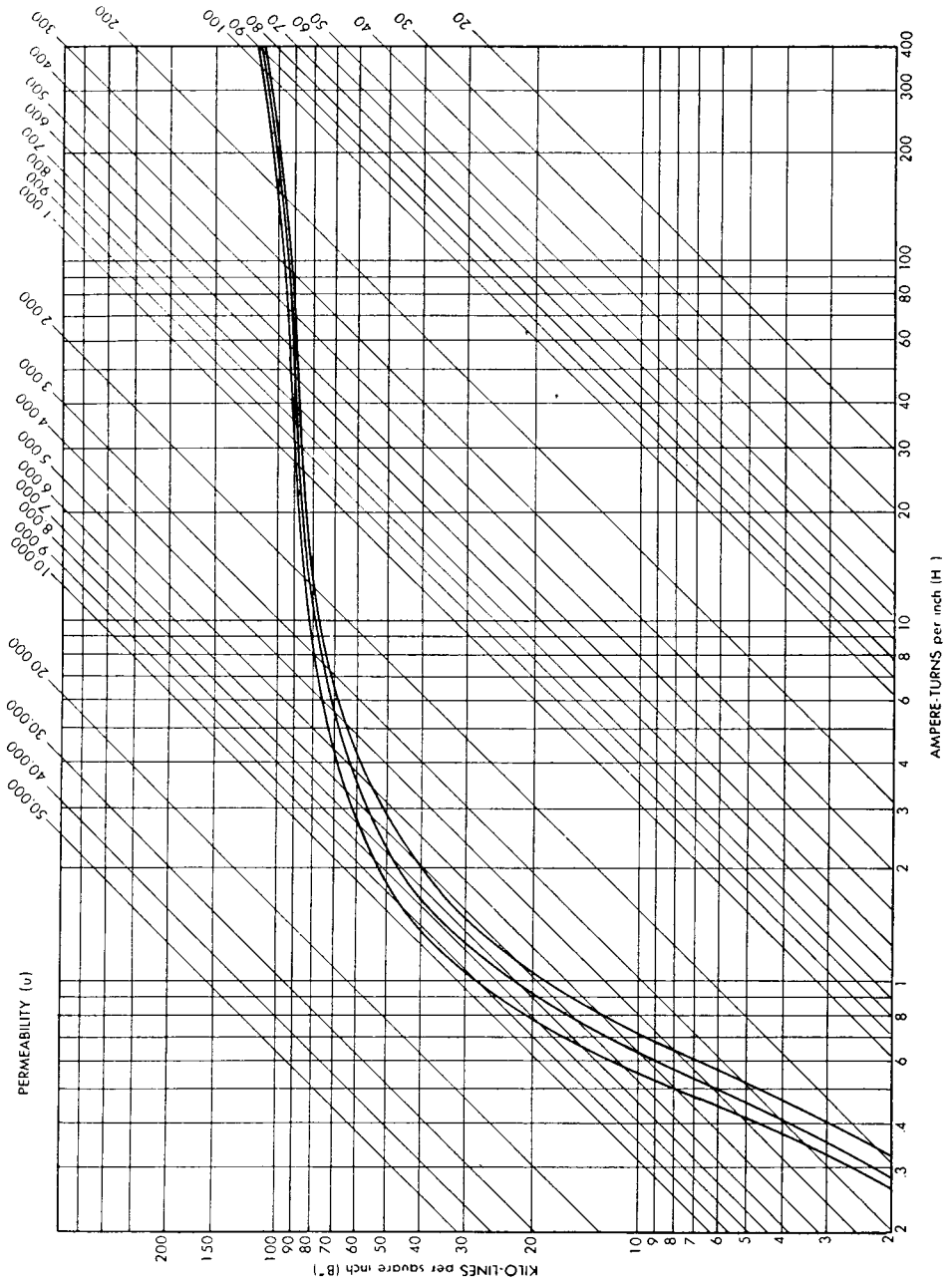



FIGURE 34—Performance Range D.C. Magnetization Permeability Curves  
 Allegheny Transformer "A" Grade Steel Sheets  
 (English Units)





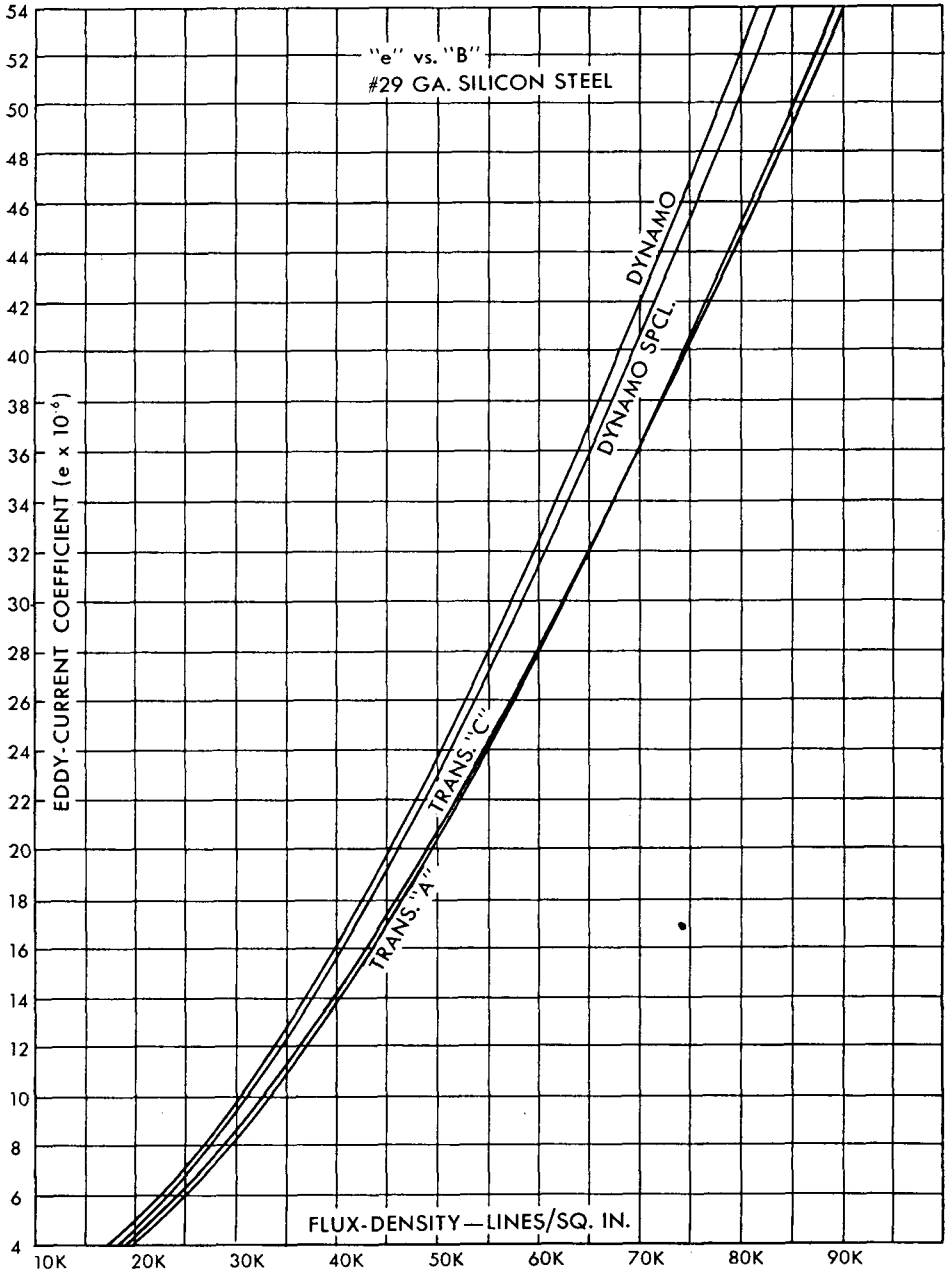

FIGURE 36

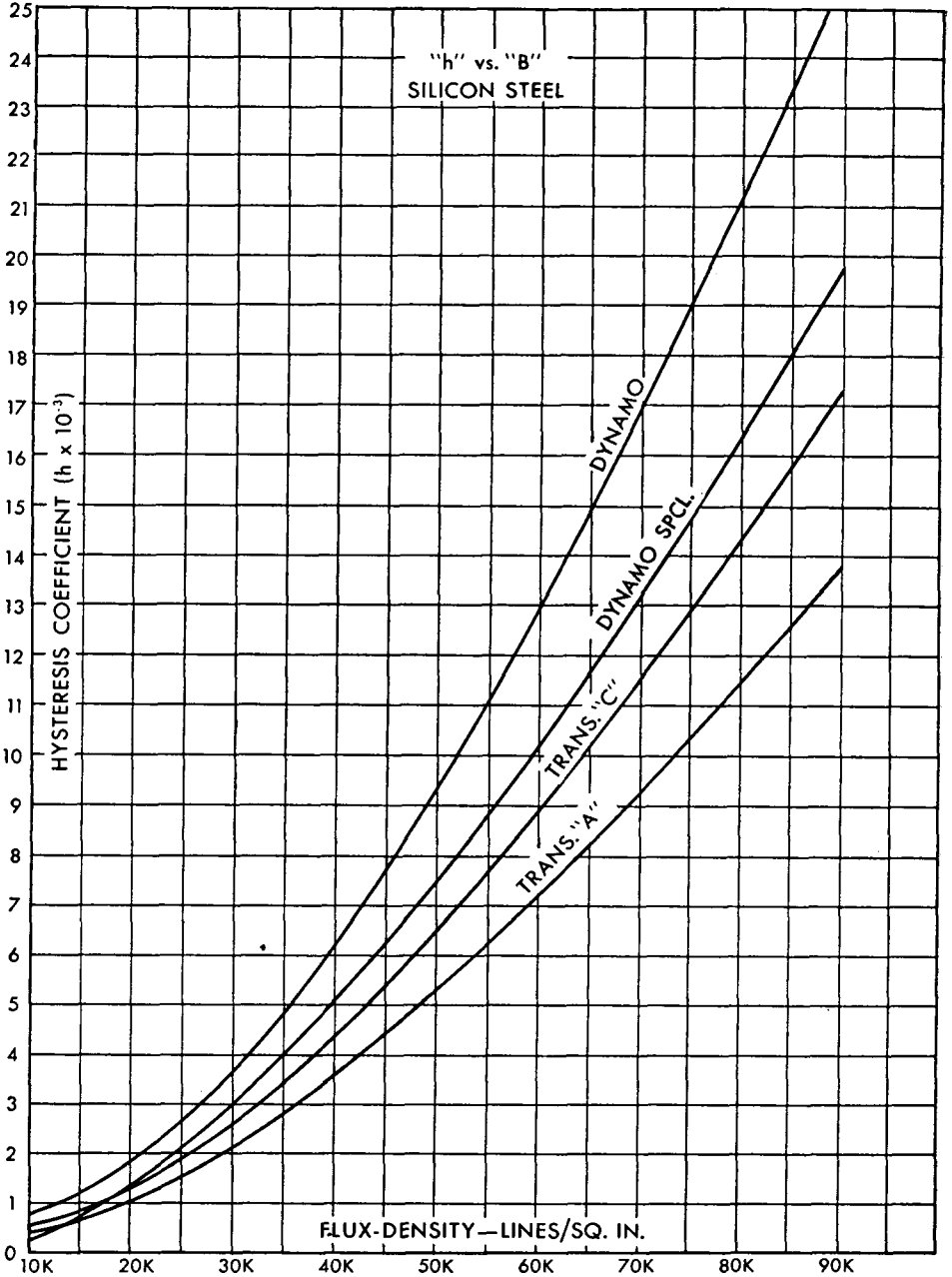

FIGURE 37

# Development of Basic Transformer Formula with Design Examples

---

■ In the preceding chapters, it has been explained that the design of vibrator transformers differs considerably from that of small AC transformers. The principal difference is primarily the result of limiting factors and characteristics of the vibrator, the contacts of which must commutate the direct current of an inductive circuit. Therefore, design decisions can only be made after the possible effect on the vibrator performance and life have been determined.

The procedure for the design of vibrator transformers will require reference to the general information of the preceding chapters and especially to the graphs and data sheets in Chapter VII. For simplification it will be limited initially to an input voltage of 6 volts as obtained from the storage battery of an automobile, since a majority of the applications are for this type of service. This basic information will then be expanded to include other input voltages.

## I. Auto Radio Power Units

The 6-volt electrical system of automobiles includes a battery which has considerable reserve capacity, and a charging generator for maintaining the charge in the battery. Therefore, the efficiency of the vibrator system is not too important from the viewpoint of battery drain. The charging system creates the problem of a widely varying input voltage. When the charging system is not operating, the input voltage may be as low as 5.5 volts. When a voltage-regulated generator is charging at a maxi-

mum rate under adverse conditions, the input voltage may be as high as 8 volts. The power supply must be designed to operate satisfactorily over this entire range of voltages.

Most power supplies for automobile radio equipment, supply loads of medium to heavy values, from the standpoint of vibrator loading, and thus are quite representative of vibrator supplies in general. When used on 6-volt batteries without chargers, such as for home receivers, portable receivers, etc., they usually supply a much lighter load, and more consideration must be given to overall efficiency and other factors than is the case with automobile units. Therefore, these latter applications will be discussed later.

The two important differences between a sine-wave input voltage and that of the vibrator-input voltage to the transformer are (1), the wave form of the voltage, and (2), the discontinuity of the applied voltage caused by the switching interval required in the vibrator operation. The form factor of a sine-wave is 1.11 while that of the square-topped vibrator wave is approximately  $\frac{\sqrt{\omega_t}}{\omega_t}$ . ( $\omega_t$  = time efficiency of the interruptor contacts expressed as a decimal.) Thus, for a time efficiency of 85%, or .85, the form factor is  $= \frac{.922}{.85} = 1.085$ . The form factor will differ with other values of  $\omega_t$ . This requires a different equation for the calculation of flux-density and other related factors for a vibrator transformer than for a sine-wave transformer. The values of the various voltages are as follows:

**Vibrator**

$$\text{Peak Value} = E_b$$

$$\text{R.M.S. Value} = \sqrt{\omega t} E_b$$

$$\text{Avg. Value} = \omega t E_b$$

$$\text{Form Factor} = \frac{\sqrt{\omega t}}{\omega t}$$

**Sine-Wave**

$$\text{Peak Value} = 1.414E = E_m$$

$$\text{R.M.S. Value} = 1.0 E = .707 E_m$$

$$\text{Avg. Value} = 0.90 E = .637 E_m$$

$$\text{Form Factor} = \frac{3.1416}{2\sqrt{2}} = 1.11$$

$$\text{Form Factor} = \frac{\text{R.M.S. Value}}{\text{Average Value}}$$

The development of the voltage equation for a vibrator transformer is quite similar to that for a sine-wave transformer. The induced voltage is determined by the rate of change of flux-linkages such that

$$1) \quad e_i = N_1 \frac{d\Phi}{dt} 10^{-8} \text{ volts}$$

where:

$e_i$  = instantaneous value of the induced emf.

$N_1$  = number of active primary turns  
 $\frac{d\Phi}{dt}$  = time rate of change of magnetic flux.

Since the rate of change of flux must be constant or linear to induce a constant opposing voltage and as it has already been shown in the preceding chapter that to make this induced voltage equal to the input voltage, the flux value must change from a minus maximum to a positive maximum, it can then be written

$$(2) \quad \frac{d\Phi}{dt} = \frac{2\Phi_{max}}{t}$$

where  $t$  (time) is equal to one-half cycle of the vibrator so that

$$(3) \quad t = \frac{\omega t}{2f}$$

where:

$\omega t$  = time efficiency of the interrupter contacts expressed as a decimal  
 $f$  = frequency of the vibrator

Substituting equation (3) for " $t$ " in equation (2) then

$$(4) \quad \frac{d\Phi}{dt} = \frac{2\Phi_{max} 2f}{\omega t} = \frac{4f\Phi_{max}}{\omega t}$$

since

$$(5) \quad \Phi_{max} = BAK_c$$

where:

$B$  = flux density in the core

$A$  = apparent cross-sectional area of the core

$K_c$  = core-stacking factor

The factor  $K_c$  is necessary as there will always be some air space between the laminations used in making up the core. This factor then represents the percent of iron in the core and will depend upon how tight the laminations are compressed. Substituting in equation (4)

$$(6) \quad \frac{d\Phi}{dt} = \frac{4f BAK_c}{\omega t}$$

Inserting (6) in equation (1) and by transposing

$$(7) \quad e_i = \frac{4f BAK_c N_1}{\omega t} 10^{-8} \text{ volts}$$

Assuming that the operating condition is at no load, in order to simplify the consideration, the battery voltage  $E_1$  can be assumed to be equal to the induced voltage  $e_i$ , as the primary IR voltage drop can be considered as being negligible. Then

$$(8) \quad E_1 = e_i = \frac{4f BAK_c N_1}{\omega t} 10^{-8} \text{ volts}$$

The active primary turns required will then be

$$(9) \quad N_1 = \frac{E_1 \omega t}{4f BAK_c} 10^8 \text{ turns}$$

It must be remembered that in a vibrator transformer the primary is center-tapped and only one-half of the winding is active during each half cycle so that the total primary turns is twice that of  $N_1$  given above. From the above, the flux-density in lines per square inch can be determined as,

$$(10) \quad B = \frac{E_1 \omega t}{4f N_1 AK_c} 10^8 \text{ lines per sq. inch}$$

and the primary turns per volt

$$(11) \frac{N_1}{E_1} = \frac{\omega_t}{4f BAK_c} \text{turns per volt}$$

To determine the value of secondary voltage in terms of the primary voltage:

$$(12) \frac{N_2}{N_1} = a = \text{turn ratio (voltage ratio)}$$

At no load, assuming perfect transformation

$$(13) \quad E_2 = E_1 a$$

and under load

$$(14) \quad E_2 = [E_1 a - (I_1 R_1 a + I_2 R_2)] \omega_t$$

where:

$\omega_t$  = Time efficiency of the vibrator  
expressed as a decimal

$N_2$  = Active secondary turns ( $\frac{1}{2}$   
total)

$I_1 R_1$  = Primary resistance voltage  
drop (including vibrator)

$I_2 R_2$  = Secondary resistance voltage  
drop (see paragraph below)

$E_2$  = Average voltage @ first filter  
capacitor

The above formula is approximate but is sufficiently accurate for vibrator transformer work. Experience shows that  $E_2$  as determined is always lower than the secondary voltage produced by the actual transformer. This is an advantage as any revision found necessary in the transformer design is in the nature of reducing secondary turns so that it is never necessary to increase the transformer size.

Where a self-rectifying type of vibrator is used, the value of time efficiency ( $\omega_t$ ) for the rectifier contacts will be lower than that of the interrupter contacts. Therefore, it is necessary to use this value in figuring equation (14). However, if an interrupter type of vibrator is being used, the governing time efficiency will be that of the interrupter contacts. Also, in the latter case, the secondary voltage-drop must include the voltage drop of the rectifier tube in addition to voltage drop of the transformer secondary.

The primary resistance voltage-drop should also include the voltage drop of interrupter contacts which is appreciable at the currents normally handled. This is somewhat variable, more or less unpredictable, and injects an unfavorable factor into the design. Judgment, based upon experience and empirical determinations, must be used in the equations since factual data is not available. Sufficient laboratory tests, involving the use of special instruments, have been concluded to determine the value of this contact-resistance under a given set of conditions. The value of contact resistance existing under operating conditions (dynamic values) are not the same as those measured under static conditions. The static condition refers to contact resistance measurements made when the reed is maintained in a deflected position by the same deflection as attained in operation. Tests have been conducted under dynamic conditions with the contacts carrying an average current of 5.0 amperes, as measured with a DC meter in the battery lead. For these conditions, the average contact-resistance per contact pair for several series of Mallory vibrators are given below:

#### "Q" Series

Mallory 4-contact type .045 Ohms

"Jr. 90," "Jr. 65" and "Jr. 40" Series

Mallory 8-contact type 0.055 Ohms

While data is not available at this time upon the other series of vibrators, it is reasonably safe to assume that the value for the "MQ" Series will approximate that of the "Q" Series. The value for the 2500 Series (250-cycle) and 2-volt Series vibrators will be much lower than those given above, since precious metal contacts are used in these mechanisms with a resulting lower value of contact resistance. For lower values of current, the values of contact resistance drop slightly, but only a slight error will result in the average design if the above figures are used. At higher values of current, these values will increase rapidly and this effect must be estimated and taken into consideration in figuring the design.

Regardless of the accuracy of the calculations, and of the estimates involved in making them, the final transformer design quite often must be predicated upon the results of a tested sample built from the computations. This is necessary not only because of the use of estimates, but also because of the number of variations that exist between individual vibrators of the same design. It is, therefore, desirable to actually test the sample with a quantity of representative vibrators to determine the average performance. Also, because of the unavoidable variation in the magnetic characteristics of steel, a test must be made to accurately determine the final value of the timing capacitor that will be necessary. This will be clarified by the discussion in a later chapter on Timing Capacitors.

After the input voltage and vibrator characteristics are known, the design of the transformer consists primarily in determining suitable values for the Number of Primary Turns, Core Area, and Flux Density. Following the determination of these factors, the next step is to determine the required wire sizes, the core size required to contain the necessary copper, and the build necessary to provide the required cross-sectional area, "A."

### Primary Turns

The number of primary turns necessary may be determined from formula (9) after the Core Area and the Flux Density have been selected.

$$(9) \quad N_1 = \frac{E_1 \omega_t 10^8}{4f BAK_c}$$

In using the above formula the factor  $E_1$  should represent the highest input voltage to be encountered in the application. Also  $N_1$  represents only one-half of the primary as was pointed out previously.

### Core Area

The core area is determined by computing the required primary watts and basing the area necessary upon previous experience. However, the following formula may be used as a close approximation:

$$(15) \quad A = \frac{\sqrt{\text{Watts}}}{5.58} \text{ square inches}$$

### Flux Density

The principal factors involved in the selection of a maximum value of flux density for the transformer depend upon the application of the power supply. For the 6-volt automobile radio service, efficiency is of secondary importance, although the effect of added heating caused by core losses can be troublesome. Since we must consider a range of operation covering an input voltage of from 5.5 to 8.0 volts in the usual application, the transformer with its associated components must work satisfactorily with a range of flux density in the same proportion. In this case, the highest value of maximum flux density is 1.45 times the lowest value. Over this range of flux densities the B-H curve (flux density vs. ampere-turns) of the lamination steel has considerable curvature except at a very low value of "B." This was shown in Figure 15.

Since the ideal condition of a linear relationship cannot be economically achieved, the upper limit of flux density must be held to such a value that no undue hardship is imposed upon the vibrator. Originally this upper limit was found to be very satisfactory when set at 65,000 lines per square inch with a 9-volt input. This resulted in a lower limit of 39,700 for 5.5 volts. For "Dynamo" (Allegheny) grade of steel, the respective values of "H" for the above flux densities would be 4.0 and 2.0. Thus "H" increases 2 times for an increase in flux density of 1.64 times.

While transformers designed around the above values of flux density had become more or less a standard of comparison and had performed excellently, the trend was to design smaller and more compact auto receivers. Thus it became necessary to design smaller and lower cost component parts, including the power supply components. At the same time, most of these newer receivers were used on automobiles having voltage-regulated charging systems, which permitted setting the upper limit of operation around 8.0 volts instead



of 9.0 volts as had formerly been the case. This, in turn, reduced the spread between low and high-voltage operation compared to the previous condition.

This has resulted in the revision of the maximum flux density at maximum input voltage. Now it has been found possible to set the maximum limit of approximately 65,000 lines per square inch at 8.0 volts input instead of 9.0 volts as formerly used. This actually increases the maximum flux density allowable. Under the former conditions, the flux density at 8.0 volts was approximately 58,000 lines per square inch. Under this revised condition, the values of "H" corresponding to values of "B" of 65,000 and 44,700 are 4.0 and 2.2 respectively for "Dynamo" (Allegheny) grade of steel. In this case "H" (Ampere-turns) increases by 1.82 times where "B" increases by 1.45 times.

Another factor which allowed satisfactory vibrator performance at higher flux densities is that connected with the small shift in vibrator characteristics occurring with a change of input voltage from the low to the high value. With an increase in input voltage, the driving power of the vibrator is increased, the exact amount being determined by the design. This increased driving power causes a small increase in frequency and a small increase in percentage of time efficiency. The increase in frequency will cause a slight decrease in flux density and the increase in percentage of time efficiency will tend to increase the flux density, and in this way the two changes tend to counteract each other. However, the comparatively small percentage increase in time efficiency results in an equal percentage decrease in the "off-contact" time interval. The ratio of the new "off-contact" time interval to the old is, however, much greater than is the ratio of the old time efficiency value to the new. This effect aids in matching the single value of timing capacitor to the two extremes of input voltage operation. This can be illustrated by the following values:

(16)	Voltage Input.....	6	8
	Time Efficiency.....	.84	.87
	Frequency.....	113	116

"Off-Contact" Interval (O-C)..... .16 .13

$$\text{Ratio of } \frac{\omega_t \text{ @ } 6V.}{\omega_t \text{ @ } 8V.} = .965$$

$$\text{Ratio of } \frac{(\text{O-C}) \text{ @ } 8V.}{(\text{O-C}) \text{ @ } 6V.} = .812$$

Again, the full effect of this point will be understood after the discussion of timing capacitors in a later chapter.

### Wire Size

The size of the copper magnet wire that must be used is generally determined by the magnitude of the input and output currents. If good regulation of the output voltage is required, it will be necessary to use larger wire sizes on both the primary and secondary coils than would be required where regulation is to be sacrificed for low cost, small size, or similar reasons. If the output power tubes of the receiver in question are to be operated as a "Class B" or "Class AB" amplifier, good regulation is desirable. Since most receivers have a "warm-up" period following the application of power, any voltage applied to the output circuit of the power supply will be essentially the "no load" voltage during this interval. Good regulation might be required in order to prevent this "no load" voltage from exceeding the rating of the component parts, especially the paper, mica and electrolytic condensers.

The wire sizes must also be large enough to prevent the over-heating of the coil and a subsequent failure of insulation through charring. When figuring the heating effect of the current in the windings, it should be remembered that both the primary and the secondary coils are center-tapped, and that each half of each coil only carries current during one-half of each cycle.

If the average battery-lead current is measured with a DC ammeter as  $I_1$ , the peak battery-lead current will be:

$$(17) \quad \text{Peak } I_b = \frac{I_1}{\omega_t} \text{ amperes}$$

$$(18) \quad \text{R.M.S. } I_b = \frac{\sqrt{\omega_t} I_1}{\omega_t} \text{ amperes}$$

(see page 96)

The heating watts in the primary coil will be:

$$W = I^2 R = (\text{R.M.S. } I_b)^2 R_1 = \left( \frac{\sqrt{\omega t}}{\omega t} I_1 \right)^2 R_1$$

$$(19) \quad W = \frac{\omega t}{\omega t^2} I_1^2 R_1 \text{ watts}$$

where  $R_1$  is the average resistance of each half of the primary.

Since we are interested in the losses in only half of the primary, we have

$$(20) \quad W = \frac{1}{2} \frac{\omega t}{(\omega t)^2} I_1^2 R_1$$

and rearranging

$$(21) \quad \frac{1}{\sqrt{2}} \left( \frac{\sqrt{\omega t}}{\omega t} I_1 \right) = \sqrt{\frac{W}{R_1}}$$

From (21) it will be seen that in figuring the required wire size to prevent overheating, the value of current to be employed in the calculations is related to the R.M.S. value by the reciprocal of the square-root of 2. For example, if the peak-value of battery current is found to be 1.0 ampere, the value used for calculating is .707 ampere. The high peak charging currents into the secondary filter condenser upset the exact calculations, but the above furnishes a very close approximation sufficient for average purposes.

The same procedure can be followed for determining the copper loss in the secondary.

For vibrators having a high value of time efficiency, only slight errors are introduced by using the average value of battery (or output) current, as measured by a DC ammeter, instead of the R.M.S. value shown above. As the time efficiency is reduced, however, the error becomes appreciable, as is shown in the following table:

$\omega t$	$\frac{\sqrt{\omega t}}{\omega t} I_1$
.800	1.119 $I_1$
.825	1.102 $I_1$
.850	1.086 $I_1$
.875	1.070 $I_1$
.900	1.055 $I_1$

*It should be noted that, when concerned with IR voltage-drop computations, the full*

*value of  $I_b$  should be used and not the reduced value, since this effect is an instantaneous one in contrast to the heating effect.*

In most cases of automobile receivers, as now designed, heating considerations are usually the limiting factors on wire sizes. The large majority of receivers use a single tube output power stage, with the current drain for the set being essentially constant with signal-input variations. A few models use a "push-pull" power output stage, some of which do have variable current drain with signal-input variations.

The cross-sectional area of round copper wire is usually expressed in units known as "circular-mils" (cm). One circular-mil is the area of a wire one mil (.001") in diameter. The area of any round wire in circular-mils is equal to the square of the bare diameter expressed in mils. For an example, #30 B & S Gauge wire is .010", or 10 mils, in diameter, and has an area of 100 cm.

An area of 1000 cm. per ampere has been considered desirable for a conservatively designed transformer. In many instances, considerably higher values have been used, especially when the use of a lower value involves a wire size so small that the difficulty of handling and cost of the wire make its use undesirable and expensive. This usually occurs when sizes from #40 up are involved, and since auto receiver loads seldom involve any such small wire sizes, it is only of academic interest at this moment. A value in the neighborhood of 1000 cm./amp. results in a larger overall size, greater cost, and increased use of materials, and for these reasons is seldom used in the automobile receiver industry.

The average design under present conditions centers around a value of 700 cm./amp., which has proven to be a rather acceptable compromise between size and cost on the one extreme, and regulation and heating upon the other. Values on either side may be encountered, as other factors affect the exact size of wire that must be used in a given design.

Only under extreme conditions of space or cost requirements will values in the region between 500 and 600 cm./amp. be

justified. And under these conditions it is reasonable to expect short transformer life, over-heating, and possibly shortened vibrator life. Where short operating periods of time are involved, or where unusual cooling means are available, the use of such values can also be justified. In test equipment, such as portable "meggers," cable testers, etc., these values would probably be satisfactory, since this sort of apparatus usually operates intermittently.

The above values are considered as starting points for initiating designs, and refer to the currents being handled at the rated input voltage of the unit—in other words, the input and output currents that are to be expected at the nominal input voltage at the transformer center-tap.

As an example, in an application requiring an output current of 50 ma. DC and an input current of 4.0 amperes, the wire sizes would be determined by the following calculations:

Approx. Current-Density: 700 cm./amp.

Vibrator Time Efficiency: 0.85

$$\text{R.M.S. } I_b = \frac{\sqrt{.85}}{.85} \times 4.0 = \frac{1.085 \times 4.0}{4.34 \text{ A.}}$$

$$\text{R.M.S. } I_2 = 1.085 \times .050 = .0543 \text{ A.}$$

Formula (18)

$$\text{Effective Heating } I_b = .707 \times 4.34 = 3.068 \text{ Amps.}$$

$$\text{Effective Heating } I_2 = .707 \times .0543 = .0384 \text{ Amps.}$$

$$\text{Primary cm.} = 700 \times 3.068 = 2148 \text{ cm.}$$

$$\text{Secondary cm.} = 700 \times .0384 = 26.9 \text{ cm.}$$

From the table in Figure 26, Chapter VII:

$$\#36 \text{ wire} = 25.0 \text{ cm.} \quad \#35 \text{ wire} = 31.4 \text{ cm.}$$

$$\#36 \text{ wire} = \frac{25.0}{26.9} \times 700 = 650 \text{ cm./amp.}$$

$$\#35 \text{ wire} = \frac{31.4}{26.9} \times 700 = 817 \text{ cm./amp.}$$

$$\#17 \text{ wire} = 2052 \text{ cm.} \quad \#16 \text{ wire} = 2580 \text{ cm.}$$

$$\#17 \text{ wire} = \frac{2052}{2148} \times 700 = 669 \text{ cm./amp.}$$

$$\#16 \text{ wire} = \frac{2580}{2150} \times 700 = 841 \text{ cm./amp.}$$

Thus, we see that, for a more conservative design, #16 for the primary and #35 for the

secondary would be used. For the less conservative design, #17 for the primary and #36 for the secondary would be satisfactory.

One difficulty, encountered in the use of a wire having too small a diameter, is that hot-spots will develop within the body of the winding which will cause rapid deterioration at that point, even though unusual cooling methods are used.

Another factor that affects the choice of wire size is the location of the coil with respect to the other coils. By placing the primary next to the core form (inside of the secondary), one size smaller wire can often be used, and still maintain the coil resistance at approximately the same value, than would be required when the primary is wound over the secondary coil. The current density would naturally increase with such a change, but other factors often make it desirable to take advantage of this arrangement. One of these is the fact that a few additional turns per layer can be used with the smaller wire size, and this is a big advantage in designing the primary, where large wire is necessary and the turns per layer are naturally limited. The secondary coil mean-length-of-turn, of course, is increased by this winding being placed over the primary, but this does not create a difficult situation to control since smaller wire sizes are involved. The increased resistance of this winding can usually be compensated for by a small increase in the number of secondary turns.

Another factor to be considered is that automatic coil-winding machines can, in general, handle wire sizes from #17 and smaller. Number 16 and larger sizes require hand-winding, or at least special handling, which increases the bulk and cost of designs in which these sizes are required. If, by placing the primary next to the core the wire size can be made #17, it is quite probable that the coils can be wound with the automatic machinery, whereas special handling would otherwise be required.

### Coil Design

Still another factor that indirectly affects the choice of primary wire size is the

fact that, at least for the usual 6-volt application, the number of layers of wire available for the primary winding is limited to three, or in a few cases four, for the wire diameters normally required. This bears directly upon the information contained in the preceding paragraphs. The fact that a large number of application designs require only three primary layers involves bringing the center-tap of the winding from the center of one layer, which is an undesirable, though a necessary procedure. Because of the greater number of layers involved in the secondary winding, and also because of the comparatively fragile wire necessary, it is common practice to design the secondary with an even number of layers. This permits the center-tap to be made at the end of a layer.

Other factors involved in the coil design may be outlined as follows. In many applications, it has been necessary to isolate the primary from the secondary electrostatically in order to prevent the transmission of "hash" interference from one circuit to the other. This is accomplished by the inclusion of a "static shield" between the respective coils which consists of a sheet of copper or brass foil the width of the coil and wound around the coil so as to overlap itself. This overlap is insulated, so that a short-circuited turn does not occur. The shield is usually grounded to the core, and from there to the receiver chassis. This device is moderately successful, but adds considerably to the cost and to the bulk of the coil without eliminating any of the major components of the interference filter. It is no longer in general use.

Where some isolation is still desired, the present trend is to wind the secondary coil and make its connections in such a manner that some large measure of self-shielding results. This is done by what is known as the "inversion" of the secondary. To accomplish this, the two halves of the secondary are wound as in any other design, but instead of the center-tap occurring at the mid-point of the two windings, the "start" of the first half and the "finish" of the secondary half are connected together to form the "center-tap." Thus, the "finish" of the first half and the "start" of the

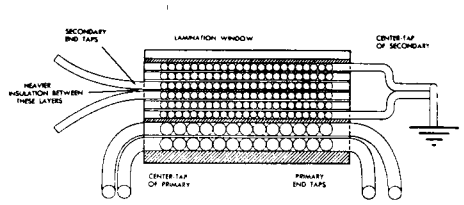

FIGURE 38a

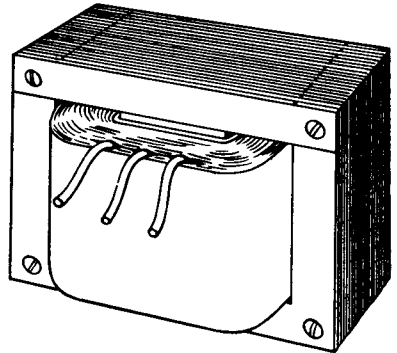

FIGURE 38b

second half become the end-taps of the winding. Figure 38a illustrates this arrangement. When the "center-tap" of the secondary winding is connected electrically to ground, the layer of the secondary adjacent to the primary is essentially placed at ground potential, and thus acts as a shield between the rest of the winding and the primary. In this case, however, the full difference of potential of the secondary exists between the two center layers of wire and sufficient insulation to withstand this voltage must be used.

Figure 38b illustrates the final form of the coil and core assembly of the "shell" type of transformer normally used in vibrator service. The laminations have been interleaved and held in place by insulated bolts prior to impregnation. The insulation around the bolts is usually a thin paper tube, or similar device, and is used to reduce the electrical conductivity between laminations and thus to reduce the eddy-current losses in the core.

Figure 39a illustrates the coil assembly features that have been previously discussed. The inner-tube coil support, which is designed to slip over the center-leg lamination assembly of the proper stack, is

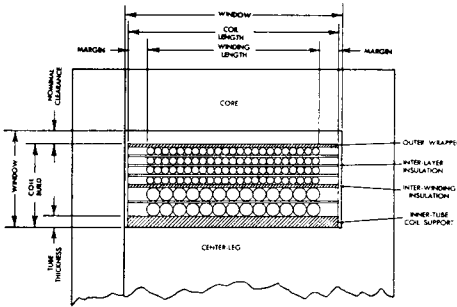

FIGURE 39a

usually pre-formed and constructed before winding takes place. It may be made of spirally-wound cemented tubing, or of layer-wound heavy kraft paper cemented over each layer, the winding form furnishing an inside dimension which provides suitable small, mechanical clearances to permit the satisfactory assembly of the laminations. For automatic-winding machinery, the core tube would be made the full length of the machine capacity, and would be carried upon an arbor to be mounted in the machine. For individual winding machines, the core tube would be cut off to the proper length, shown on the diagram of Figure 39a as the "coil length."

Assuming in this instance that the wire size is such that the primary winding can be placed next to the core, the large primary wire would then be wound over the core tube, with the proper thickness of inter-layer paper placed between each successive layer. This paper thickness is selected by consulting the table in Figure 26 for the wire size required. If the voltage insulation between this first winding and the core is to be high, such as would be the case if the first winding were to be the secondary, additional insulating paper or cloth might be interposed between the Kraft core tube and the first layer of wire. The required clearances for the electrical insulation and for proper mechanical support at the ends of the coil necessitate that the winding length be less than the coil length. This is shown in Figure 39a as the dimension noted "winding length." Commercial practice relative to these dimensions are shown in the table given in Figure 26.

If the primary winding and leads have been applied smoothly, the addition of an inter-winding wrapper of several layers of the same thickness of Kraft paper being used between the primary layers will serve as both insulation and a mechanical support for the secondary winding. Possibly additional glassine, or even cloth, insulation may be desired for inter-winding electrical insulation, but in the average 6-volt application this is not required. If large wire size on the primary winding, bulky lead arrangement, or such similar problems prevent a smooth and even winding surface being provided for the secondary, the secondary must often be wound on a second core tube which will slip over the primary winding in making the assembly. This is an uneconomical procedure and is also wasteful of window space, and is to be avoided if at all possible.

Referring again to Figure 39a, it will be seen that the coil "build" occupies only a portion of the window height. The inner tube coil support occupies a more or less fixed dimension, depending upon the size of the lamination, and in some respects upon the size of the wire being supported. For the sizes of laminations under consideration, two thicknesses of tube are considered sufficient: .035" for the smaller lamination sizes and .050" for the larger ones. The table in Figure 26 furnishes a guide to these selections. The remainder of the "coil-build" dimension is made up of the layers of wire plus inter-layer insulation and inter-winding and outer wrappers. The total coil-build represents only a fraction of the window height, the remainder being clearance to accommodate bulging of the coil, inaccuracies of winding, and ease of assembly of the laminations. This clearance amounts to from roughly 10% to 15% of the window height. However, since the dimensions are smaller in the smaller laminations, the percentage for clearance in those instances will be higher to secure satisfactory mechanical clearance. It is suggested that the coil-build be limited, as shown in the tables of Figure 26, or that the clearance be kept at a minimum of 15% in each instance.

During the process of winding the coil, required leads are often attached to the winding wire, in order to anchor them in the windings and furnish a strong assembly. With coils wound on automatic machinery, however, where the units are wound in multiple, this is usually a finishing operation after the coils are completed. The leads are brought out, or are attached to the coil, on the sides which do not fit into the lamination window, as is shown in Figure 39b. Often they are located on opposite sides of the coil instead of as shown, in order to reduce the bulging of the coil in its finished state. If minimum clearances must be maintained, to fit the unit into some tight dimension, the leads may be anchored at the corners of the coil so as not to increase the over-all dimension greatly.

The leads, especially on the primary, may be "self-leads" if the wire size is sufficiently large to provide satisfactory strength and handling ease. Otherwise, the leads are of insulated wire, usually flexible, which is anchored in the coil assembly.

During the winding of multiple coils the inter-layer insulating paper is fed into the machine in wide strips, or sheets, which are the full width of the core tube. These sheets are of sufficient length so that the paper extends around the completed layer with a satisfactory overlap. The lap in the insulation is always maintained on the two sides of the coil assembly which will be outside of the window. In this manner the overlap and the lead placement will not decrease the window space available for wire. The leading of the end-turn of one layer to the start of the next layer, which can cause some distortion of the coil, also should take place in this same general location.

Following the completion of the multiple winding, the outer-wrapper is anchored, and then the coils are separated by a set of cutting knives or saws. These knives are spaced correctly so as to separate the assemblies into coil lengths that will fit into the required window lengths. The leads are then attached and the coil is finish-wrapped. Then follows the impregnation process.

## Impregnation

The primary purpose for impregnating insulated electrical windings is to remove any moisture entrapped in the absorbent insulating materials and carried in the air voids, and to erect a barrier against the return of moisture. The barrier is an impregnating compound which is itself a moisture impervious insulator as compared to the original insulation. Temperature, humidity, and possibly corrosive gases, can combine to cause failure of electrical windings through destruction of the copper wire or of breakdown of the insulation. This is caused by the chemical actions resulting from this combination, or by charring of insulation through over-heating, or both.

The removal of all moisture is an essential step in the impregnating process, and its importance cannot be overlooked. This process can be carried out in varying degrees of perfection, depending to a large extent upon the added cost that can be tolerated, as well as upon the equipment that is available and the time cycle permissible in the production schedule. The simplest procedure is that of baking the assembly in a ventilated oven just prior to impregnation. An improved method consists of making the heating cycle with the oven under a vacuum which greatly assists and speeds up the dehydration of the windings. The time involved depends upon the size and relative volume of the windings, but should be at least long enough to permit all of the winding to be heated sufficiently so that all entrapped or absorbed moisture is driven off.

The impregnating compound must have characteristics that will permit it to enter into the layers of the windings, fill all voids and saturate the absorbent insulating materials. This not only blocks the re-absorption of moisture, but improves the dielectric characteristics of the insulation, provides for improved heat transfer from the interior of the coils, and in some cases provides a certain amount of mechanical protection for the windings. The impregnant also serves as an anchor to hold the coil to the core assembly, and also as a

medium for holding the laminations firmly in place. The latter prevents lamination vibration and hum.

There are many impregnating processes in use at the present time. The one used by any individual manufacturer depends upon the equipment available, the requirements of the customer's application, the allowable production cost, and the final assembly or mounting design. Obviously, if the core and coil assembly is to be mounted in a hermetically sealed container, the impregnation process need not provide as perfect a moisture barrier as would be required with an open mounting.

However, the usual 6-volt power unit will not use hermetically sealed transformers. The mounting will ordinarily consist of either of two types. In one, the transformer is anchored to the chassis and covered with a removable sheet-metal box, without any "potting" compound filling the unoccupied portions of the case. The other type of mounting consists of assembling the transformer in a sheet-metal or drawn-steel case and potting the unit with a high-melting-point compound. This anchors the core and coil assembly in place, together with the leads, in their proper location for assembly to the chassis. The encased assembly is then secured to the chassis. While both methods are common, the latter one provides for somewhat greater heat transfer to the outer-case from the transformer.

The most simple of impregnating methods consists of dipping the heated core and coil assembly into melted wax especially compounded for impregnating purposes. After a period of immersion, determined experimentally to be sufficiently long to permit complete saturation of the coil, the assembly is permitted to drain and cool. A refinement of this method consists of adding a means for the vacuum removal of air from the heated assembly, followed by pressure impregnation with the wax.

The above methods can be used employing a baking varnish for the impregnant. However, such processes require an oven-baking period, following the draining period, to dry the varnish throughout the depth of the coil. Most of the baking var-

nishes are of the oxidizing type and depend upon the oxidization of the carrier-oil to provide proper curing. Entrapment of solvent or uncured oil through incomplete curing can result in a rapid deterioration of that part of the coil in contact with it.

A newer type of varnish has received wide acceptance, being manufactured under various trade names. This varnish is of a different nature, being so compounded as to possess "polymerizing" characteristics. The characteristics are similar to those of bakelite, or other "heat-reactive" plastics, in that the curing is not the result of solvent evaporation or oxidization, but results from a chemical reaction that occurs with the application of heat for a definite length of time. The result is a superior penetration, complete curing throughout, high-strength coil, with good mechanical protection, and excellent protection from exposure to moisture and corrosion. Repeated dips and baking can provide sufficient protection to eliminate the need for added potting, etc.

Wax impregnation does not affect the flexibility of leads, or prevent the separation of the coil from the laminations, if required. Exposure to high temperatures, however, will result in gradual dripping of wax from the assembly. Ordinary insulating varnish impregnation has some stiffening effect upon the flexibility of leads, and if properly cured, results in a fairly permanent assembly of core and coil. Since the resulting finish of the polymerizing varnish is very hard and stiff, its effect upon the flexibility of leads is rather great. While very durable and reasonably tenacious, it is naturally subject to fracture as the result of flexing of any leads. Therefore, it is suggested that solder-lug terminal boards be employed with this type of impregnation. In specifying the type of impregnation for a given application, the foregoing characteristics as well as cost must be considered. Also, the decision must depend upon the climatic conditions to which the equipment will be exposed during service, and the expected life before servicing will be required. Except for service conditions to which they will be exposed, the impregnation of vibrator trans-

formers is no different than that of other power transformers of small size.

### Lamination Size

The required lamination size to accommodate the necessary primary turns can be estimated, as well as the approximate "stack" of laminations, to provide the calculated core area determined by equation (15). For pre-calculation purposes in determining the lamination size, the space required for the secondary can be estimated as being approximately equal to that required for the primary. The secondary winding can then be calculated, and the preliminary design can be considered completed.

### Coil Resistance

One additional consideration is often desired, after the preliminary coil has been determined. This is the estimated DC resistance of the two windings. To make this estimate it is necessary to calculate a "mean-length-of-turn" for each of the primary and secondary windings. However, it is generally sufficient to arrive at an average for each winding, and thus neglect the inherent difference between the two halves of each occasioned by the different radius of the layers.

Figure 39b illustrates a cross-sectional view of a typical coil mounted upon a laminated core, with dimensions that will be used in determining the M.L.T. (mean-length-of-turn). The dashed lines refer to the M.L.T. of the primary and the secondary windings which are to be determined. If the dimensions shown are known, one method of procedure can be as follows:

Inner dimensions of core tube = X and Y

Thickness of core tube = T

Build of Primary Winding = P

Build of secondary winding = S

Thickness of primary wrapper =  $W_1$

Thickness of secondary wrapper =  $W_2$

Thickness added over leads = L

Inner-Circumference of Primary =  $Cir._1$

$Cir._1 = 2X + 2Y + 8T$

Outer-Circumference of Primary =  $Cir._2$

$Cir._2 = Cir._1 + 8P$

$$(22) \quad M.L.T._p = \frac{Cir._1 + Cir._2}{2}$$

or

$$(23) \quad M.L.T._p = Cir._1 + 4P$$

Inner-Circumference of Secondary =  $Cir._3$

$Cir._3 = Cir._2 + 8W_1 + 2L_p$  (including L)

Outer-Circumference of Secondary =  $Cir._4$

$Cir._4 = Cir._3 + 8S$

$$(24) \quad M.L.T._s = \frac{Cir._3 + Cir._4}{2}$$

or

$$(25) \quad M.L.T._s = Cir._3 + 4S$$

Either equations (22) and (24) may be used, or (23) and (25) can be substituted; however, the latter seems to be a somewhat shorter method. Following the determination of the M.L.T. of both the primary and secondary, the total average length of wire used in each half of each winding can be calculated, as follows:

$$(26) \quad \text{Length of wire} = \frac{N}{2} \times \frac{M.L.T.}{12} \text{ Feet,}$$

where M.L.T. is expressed in inches, and N is the total number of turns on either winding.

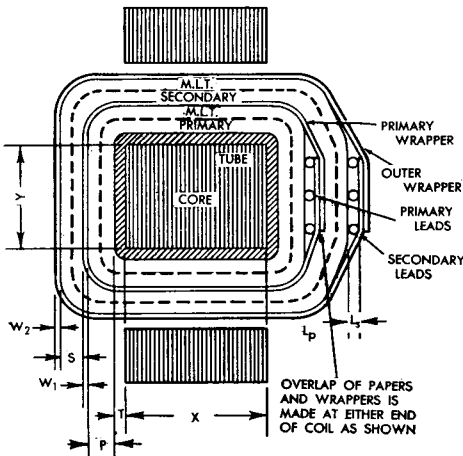

FIGURE 39b



By referring to the table of Figure 26, the resistance for the wire size involved, expressed in ohms per 1000 ft. of length, can be determined. Incidentally, winding tension during the coil-winding operation will stretch the wire to some degree, depending largely upon the size of the wire and the machine requirements. This reduces the cross-section and affects the accuracy of the results of such calculations as are being discussed here.

$$(27) \quad R_t = \frac{N \times M.L.T. \times r}{2 \times 12 \times 1000} \text{ ohms per half of winding}$$

Equation (27) allows the calculation of the average resistance of either winding, and is self-explanatory.

### Transformer Design Procedure

Most of the present designs of automobile radio receivers can be classified into two groups; those with a single power output tube and those with a dual, or push-pull, power output system. The first group will normally have a power supply output voltage of 240 to 260 volts DC at a current of from 50 to 60 milliamperes, the voltage being that measured at the first filter capacitor. The second group will usually have a power supply output voltage of 260 to 275 volts DC at a current of from 60 to 75 milliamperes. There have been, and probably will be, receivers manufactured which have power requirements outside of these ranges, but the large majority of designs will fall within these limits. With these requirements in mind, it is possible to select several arbitrary values and specifications and develop sample designs. A brief summary of the design steps are as follows:

1. List the requirements, as discussed in Chapter IV.
2. Convert the output voltage and current requirements in terms of normal rated input voltage, if originally given at a value other than normal.
3. From the values obtained in (2), calculate the output watts now required. Estimate the efficiency of the power supply from the data given in Chapter V, and then figure the input watts necessary.

From this data figure the input current required at the rated input center-tap voltage.

4. Decide upon the approximate value of maximum flux density desired, for the highest input voltage expected to be encountered in service. (Generally 8.0 volts for 6-volt systems.)

5. Select a vibrator, from the Vibrator Characteristic Data Sheets (supplied separately), whose characteristics and ratings will meet the requirements as determined above. Or, if a type of vibrator has previously been selected, see if it will be operating within its ratings when supplying the above requirements.

6. List the vibrator characteristics pertinent to the application.

7. Determine the wire sizes necessary to carry the currents previously calculated, applying the information given in Equations (17), (18), (19), (20) and (21), (Chapter VIII), relative to the RMS value of currents and the heating effect in center-tapped windings. Also refer to the discussion following Equation (21), on the current densities in the wire for various classes of designs. After the required area of the wires are determined, select the wire sizes accordingly, from the table of Figure 26.

8. Calculate the number of primary turns and the core size. Refer to Equation (15) (Chapter VIII), and to the table in Figure 26. Assume for the time being that the secondary coil-build will equal that of the primary coil. Using the preceding information, select a lamination size from the table of Figure 25 which will accommodate the required primary turns of specified wire size, and which will permit an approximately square cross-section of the center-leg to be used. As a guide, the allowable coil-build for any given lamination size, as shown at the bottom of the table in Figure 26, may be divided by 2, and the result used as the approximate build for either coil.

9. Calculate the secondary winding by first making preliminary estimates: Assume that the "regulation factor" will be about 0.70; also assume that the resistance of the secondary coil will be equal to that of the primary coil, when the latter is multiplied by the square of the turn-ratio.

Divide the required output voltage by the "regulation factor" and by the rated input voltage to secure an estimated turn-ratio.

Substitute the correct values in the Equation (14) to determine if the turn-ratio is approximately correct. The primary transformer resistance can be found by applying the data found in (7) and (8), and calculating the mean-length-of-turn of the winding by using the proper equations of (22), (23), (24) and (25).

The total primary regulating resistance is found by adding the primary coil resistance per half of the winding to the vibrator contact resistance, as discussed after Equation (14).

Correct the estimated turn-ratio if desirable. Then calculate the preliminary secondary winding by determining the number of turns required and the resultant coil build.

10. Determine the total transformer coil build and compare with the allowable build for the lamination size selected. If the design falls within the limits of less than 85% build, it may be considered satisfactory for commercial production. If the build is over 85% but under 90%, the design is questionable. However, consideration of the actual clearance in inches, the size of the lamination and cross-section of the core, and the sizes of wire being used, will determine whether or not the design can be used.

If the cross-section is nearly square and wire sizes are small, the coil can be wound with less bulging and the layers will more nearly conform to the shape of the mandrel. If the lamination is large with a correspondingly large coil, the clearance must be greater to allow for mechanical tolerances in the coil assembly, etc. If a primary of large wire is placed over the secondary, this coil may be shaped somewhat after winding to reduce excessive bulging without probable damage to the wire or insulation. If the secondary is over the primary, this cannot be done satisfactorily.

11. If the result of (10) is an over-build, a redesign will be required. An increase in the size of the lamination to accommodate more copper in the window, or a decrease

in the wire sizes to reduce the coil build in the present lamination are the first apparent measures to adopt in order to accomplish the redesign. Often a slight change in the turns used will permit the use of fewer secondary layers, which may reduce the build enough to be satisfactory with the present wire sizes. If necessary, the core stack can be adjusted somewhat to correct the flux density.

12. Calculate the new resistances of the two coils. Substitute these values in the output voltage Equation (14), to estimate if the final turn-ratio was correct. If necessary, or desirable, this factor can be refigured.

13. Write up the sample specifications.

14. Calculate the peak magnetizing currents for the extremes of voltage input, or for the maximum and nominal conditions.

15. Calculate the approximate core losses.

16. Calculate the approximate copper losses, using the RMS values of the input and output currents involved.

*Note:* Items 14, 15 and 16, as given above, are supplementary calculations and are desirable only from the standpoint of comparison of the transformer design with other similar designs to determine which transformer has the better characteristics. The calculations can only be considered approximate at best, because the performance curves and information used in calculating these results are determined on the basis of a 60-cycle sine-wave input, and, hence, cannot duplicate the action of the iron when used with the 115 or 250-cycle square wave voltage encountered in vibrator use.

## No. 1—Sample Design— Vibrator Transformer

**Requirements:** (See Chapter I)

1. To power a low-priced, single-unit auto radio receiver for domestic broadcast service; frequency range 550 to 1600 kc.: IF 455 kc.
2. Cost and size reduction are the most important considerations in the design.

3. Output = 240 volts @ 50 Ma. measured at the first filter capacitor (DC meters).
4. Input = 6.3 volts at the transformer primary center-tap (DC meter). Voltage variation = 5.5 to 8.0 volts at C.T.
5. Rectifier tube = 0Z4A.
6. Vibrator = 115-cycle Interrupter Type.
7. Smoothing filter = 10-10 mfd., 350-volt capacitor, with 500 ohms resistance connected between sections. The output power tube receives its plate voltage from the first filter capacitor connection. The rest of the receiver tubes are connected to the output filter capacitor.
8. B-voltage may be at ground potential, but the added tube in the form of the rectifier is desired. Therefore, the interrupter vibrator is used.
9. The tubes are all of the indirect-heater type, except for the gaseous rectifier. This involves a no-load condition at the start, but the initial high plate resistance of the 0Z4A offers some protective regulation.
10. Operation is considered continuous. A fairly high ambient temperature will be encountered under the cowl of the car in the summertime.
11. All of the power supply components will be mounted upon the receiver chassis. The outside case will be small and with a minimum ventilation. Proximity of the power supply to the RF portion of the receiver may result in difficulty in hash elimination.

#### Calculations: (Preliminary)

Watts Output =  $240 \times .050 = 12.0$  watts  
(DC meter values)

Estimated Efficiency = 60%

Watts input =  $\frac{12.0}{0.60} = 20.0$  watts

Current input =  $\frac{20.0}{6.3} = 3.17$  amperes (DC meter value)

Approximate Maximum Flux Density =  
 $B_m = 65,000$  lines per square inch @ 8.0 volts

**Vibrator Characteristics:** For this Sample Design, the following values are assumed as being representative.

Frequency = 115 cycles (average)

Time Efficiency = 0.85 (average).

Rated Input Voltage = 6.3 volts C.T.

Rated Input Current = 5.0 amperes (max.)

From the above calculations and characteristics we see that the estimated input current at 6.3 volts C.T. is only 65% of the maximum allowable for good life expectancy. Therefore, this type of vibrator should be acceptable.

#### Calculations: (Wire Size Determination)

Using Equation (18):

$$\text{R.M.S. } I_2 = \frac{\sqrt{.85}}{.85} \times .05 = 1.085 \times .05 = .0543 \text{ amperes}$$

$$\text{R.M.S. } L_1 = 1.085 \times 3.17 = 3.44 \text{ amperes}$$

Heating Value of  $I_2$ :

$$.707 \times 0.543 = .0384 \text{ amperes}$$

Heating Value of  $I_1$ :

$$.707 \times 3.44 = 2.43 \text{ amperes}$$

Assume a tentative value of 600 cir. mils per ampere current density:

$$\text{Secondary} = 600 \times .0384 = 23.0 \text{ cm. required}$$

$$\text{Primary} = 600 \times 2.43 = 1458 \text{ cm. required}$$

From Table in Figure 26, Chapter VII:

Secondary:

$$\#36 \text{ wire} = 25.0 \text{ cm.} \quad \#37 \text{ wire} = 19.8 \text{ cm.}$$

Primary:

$$\#18 \text{ wire} = 1624 \text{ cm.} \quad \#19 \text{ wire} = 1290 \text{ cm.}$$

$$\#36 \text{ wire: } \frac{25.0}{23.0} \times 600 = 652 \text{ cm./ampere}$$

$$\#37 \text{ wire: } \frac{19.8}{23.0} \times 600 = 516 \text{ cm./ampere}$$

$$\#18 \text{ wire: } \frac{1624}{1458} \times 600 = 668 \text{ cm./ampere}$$

$$\#19 \text{ wire: } \frac{1290}{1458} \times 600 = 531 \text{ cm./ampere}$$

In order to realize the smallest lamination size, it appears that #19 could be used on the primary if this winding is placed next to the core. #36 should be used on the secondary.

**Calculations:** (Turns and Core Determination)

$$\text{Equation (15)} \quad N_1 \times A = \frac{E_1 \times \omega_t \times 10^8}{4 \times B \times K_c \times f}$$

$$N_1 \times A = \frac{8.0 \times .85 \times 10^8}{4 \times .65 \times 10^5 \times .92 \times 1.15 \times 10^2} = \frac{6.8 \times 10^8}{2.75 \times 10^7} = 24.7$$

Estimating that the EI-11 lamination can be used as an initial trial:

From the table of Figure 26, Chapter VII: #19 = 25 T. per layer; #36 = 170 T./L.

Assume 3 layers of #19, wound next to the core. In order to simplify providing self-leads for multiple-coil winding, this example will not use all of the allowable turns per layer unless it is found they are definitely required. As an initial start:

3 layers @ 24 T. per layer = 72 T.

$$N_1 = \frac{72}{2} = 36T \quad N_1 \times A = 24.7$$

$$A = \frac{24.7}{36} = 0.686 \text{ square inches (apparent area cross-section)}$$

$\frac{1}{8}$ " Stack of EI-11 =  $0.875 \times 0.875 = 0.766$  square inches.

To check the flux density using this core with the above number of primary turns:

Equation (10):

$$B = \frac{8.0 \times .85 \times 10^8}{4 \times .766 \times .92 \times 115 \times 36} = \frac{6.8 \times 10^8}{10.43 \times 10^8} = 65,200 \text{ lines per square inch @ } 8.0 \text{ volts C.T.}$$

This will be satisfactory for a primary and core design.

**Calculations:** Secondary determination, and a check upon space occupied by coil. As an aid in determining the approximate turn-ratio needed, assume a regulation factor of 0.70 for a transformer of this class. It is also permissible to assume, temporarily, that the secondary resistance will be:

$$R_{t2} = R_{t1} \times a^2 \text{ (where } a = \text{turn ratio)}$$

Tube characteristic data sheets indicate that the 0Z4A has an average tube plate drop of 24 volts. This must be added to the required output.

$$a = \frac{240 + 24}{0.70} \times \frac{1}{6.3} = \frac{264}{4.41} = 60$$

use  $a = 60$        $a^2 = 3600$  for trial

Equation (13):

$$\text{@ No load, } E_2 = 6.3 \times 60 = 378 \text{ volts.}$$

Assuming there is no limiting action by reason of the 0Z4A characteristics.

Equation (14):

$$\text{@ load, } E_2 = [E_1 \times a - (I_1 R_{1a} + I_2 R_2)] \omega_t$$

Substituting  $a_2 R_{t1}$  for  $R_2$  in the above:

$$E_2 = [6.3 \times 60 - (3.17 \times 60 \times R_1 + .050 \times 3600 \times R_{t1})] \times .85 = [378 - (190 \times R_1 + 180 \times R_{t1})] \times 0.85$$

At this point determine the M.L.T. (mean length of turn) and  $R_{t1}$  of the primary:

Equation (23):

$$\text{M.L.T.}_p = \text{Cir.}_1 + 4P = (2X + 2Y + 8T) + 4P = 1.75 + 1.75 + 0.40 + 4P = 3.90 + 4P$$

With 3 layers of #19 enameled wire, and using .005" Kraft paper between layers (see table of Figure 26):

$$P = 3(0.38 + .005) = 3 \times .043 = .129" \text{ build}$$

$$\text{M.L.T.}_p = 3.90 + 4 \times .129 = 3.90 + 0.516 = 4.466" \text{ average or } 4.17"$$

Equation (27):

$$R_{t1} = \frac{N \times \text{M.L.T.} \times r}{2 \times 12 \times 1000} = \frac{72 \times 4.47 \times 8.05}{2 \times 12 \times 1000} =$$

0.108 ohms/half of winding where

$r =$  ohms per 1000 feet, from table in Figure 26:

See page 67 for estimated value of vibrator contact resistance:

$$R_1 = R_{t1} + R_v = 0.108 + .045 = 0.153 \text{ ohms}$$

Substituting these values of resistance in the above equation for  $E_2$ :

$$E_2 = [378 - (190 \times 0.153 + 180 \times 0.108)] \times .85 = [378 - (29.1 + 19.4)] \times .85 = 329.5 \times .85 = 280 \text{ volts (est.)}$$

Required  $E_2 = 264$  volts.

$$\text{Revised } a = \frac{264}{280} \times 60 = 56.6 \text{ (new value)}$$

The above test calculations show that the estimated turn-ratio is too high and needs revision as shown. Next determine if the secondary calculated accordingly will fit into the space allowable.

#36 enameled wire = 170 T. per layer  
(See table of Figure 26.)

$N_s = 72 \times 56.6 = 4075$  turns:

$$\frac{4075}{170} = 24.0 \text{ layers required}$$

Coil Build (for secondary):  
 $24(.0057 + .001) = .161$

Allowing .015" added Kraft paper for wrappers, in addition to the .005" Kraft already included as a part of the 3rd primary layer:

Total Coil-Build =  
 $(.050 + .129 + .161 + .015) = .355$

Total Window Width = 0.437"  
[for EI-11 lamination, see Figure 25].

$$\% \text{ build} = \frac{.355}{.437} = 81.2\%$$

Clearance = .082" or 18.8%

If the clearance had not been sufficient, a redesign of the transformer to obtain proper clearance would now be necessary. This can be done by using wire one gauge smaller in size, however, in the above example, the smallest size practical without raising the temperature of the transformer to above a safe level was used. The second alternative is to reduce the number of primary turns, and correspondingly reduce the number of secondary turns, but at the same time increasing the core area to maintain the flux density at the same value or below the maximum of 65,000 lines. If neither of the above methods produce a satisfactory transformer then the next size larger lamination must be used and a new design calculated.

**Calculations:** Determination of the Approximate Resistance (average) of both coils:

Primary: 72 T. #19, in 3 layers.  
 $R_1 = 0.108 + .045 = 0.153$  ohms per half.

Secondary: 4075 T. #36, in 24 layers.

$MLT_s = \text{Cir.}_s + 4S$ : Equation (25)

$$= (\text{Cir.}_1 + 8P + 8W + 2L) + 4S;$$

(Let "L" = 0.10")

$$= 3.90 + (8 \times .129) + (8 \times .01) +$$

$$(2 \times .10) + (4 \times .161)$$

$$= 3.90 + 1.032 + 0.08 + 0.20 +$$

$$0.644 = 5.856"$$

$$R_{t2} = \frac{4075 \times 5.586 \times 414.8}{2 \times 12 \times 1000} = 412.4 \text{ ohms per half}$$

**Calculations:** Redetermination of the secondary voltage estimate with the new data:

$$E_2 = [6.3 \times 56.6 - (3.17 \times 56.6 \times 0.153 + 0.050 \times 412.4)] 0.85$$

$$= (356.6 - 48.1) .85 = 262 \text{ volts.}$$

Required = 264 volts.

**Specifications:**

Core:  $\frac{3}{8}$ " stack of EI-11 laminations, #24 Ga. Dynamo Grade, or equivalent: Laminations to be interleaved in groups of 2x2.

Core Tube: 0.050" thick, built up from gummed Kraft paper or equivalent.

Primary: 72 turns of #19 enameled wire, tapped at 36 turns. Tolerance on number of turns and tap location + or - 0%. 3 layers, with 0.005" Kraft paper between layers.

Primary Wrapper: 1 layer of 0.005" gummed Kraft paper, in addition to the one layer included as part of the third primary layer in the foregoing calculations. Total is 0.010".

Secondary: (To be wound over the primary). 4075 or 4070 turns of #36 enameled Wire, tapped at 2035 turns. Tolerance on number of turns + or - 1%. 24 layers, with 0.001" Glassine paper between layers.

Outer Wrapper: 2 layers of 0.005" gummed Kraft paper, or equivalent.

Leads or Terminals: As required by the application and/or mounting.

**Notes:**

1. This method of calculation is rather conservative, and probably will result in a

turn ratio which will develop an output voltage that is higher than desired. This is desirable in order that any changes necessary after a sample has been built and tested will not involve the use of a greater window area. Thus, lamination dimensions will not require changing. Should a correction in output voltage be necessary, it is accomplished by the simple expedient of reducing the number of secondary turns by the ratio of the desired voltage to the measured voltage.

2. The sample transformer should be tested with a representative number of typical vibrators in order to secure an average output condition. This is also necessary in order to determine the correct timing capacitance, as will be discussed in a later chapter. Both tests may be carried out simultaneously.

3. The use of a high-vacuum rectifier tube in place of the Type 0Z4A would probably result in less output voltage being required because of the lower average tube plate drop (as given in published ratings) for the current being handled. However, based upon experience, the rating of 24 volts given for the 0Z4A in published ratings seems to be too high. Many comparative tests have shown that the output with a tube such as the type 6X5 is practically identical with that when using the 0Z4A in the normal range of currents. If this situation is encountered, the above calculated turn ratio may be adjusted accordingly.

4. Other differences in the final output voltage achieved may result from the several variations in the vibrators themselves from the rated averages. These may appear as variations in time efficiency, frequency, and contact resistance.

### Supplementary Calculations:

#### Determination of Magnetizing Currents (peak values):

Equation from Chapter VII

$$i_m = \frac{H \times l}{N_1} \text{ amperes}$$

$$l = 5.26 \text{ [See Figure (25), Chapter VII]}$$

$$H = \text{[From Figure (30), Chapter VII]}$$

$$N_1 = 36 \text{ turns}$$

#### @ 6.3 Volts C.T.

$$B = 51,300 \text{ L./sq.in.}$$

$$H = 2.6 \text{ Amp. T./inch}$$

$$i_m = 0.38 \text{ amperes}$$

$$\text{Voltage ratio} = \frac{8.0}{6.3} = 1.27$$

#### @ 8.0 Volts C.T.

$$B = 65,200 \text{ L./sq.in.}$$

$$H = 4.1 \text{ amp. T./inch}$$

$$i_m = 0.599 \text{ amperes}$$

$$\text{Current ratio} = \frac{0.599}{0.38} = 1.576$$

**Approximate Core Losses:** Equations, Curves, Figures 34 and 35, Table in Figure 25 in Chapter VII.

$$\text{Watts per pound} = (4.22 \times 10^4 \times e) + (115 \times h); \text{ for 115 cps and \#24 ga.}$$

#### @ 6.3 Volts C.T.

$$B = 51,300$$

$$e = 29.8 \times 10^{-6}$$

$$h = 9.8 \times 10^{-3}$$

$$W/\text{Lb.} = 1.05 + 1.13 = 2.18$$

$$\text{Wt. of Core} = 1.16 \text{ Lbs./in. stack} \times .875'' = 1.015 \text{ lbs.}$$

$$\text{Losses} = 2.18 \times 1.015 = 2.21 \text{ Watts}$$

#### @ 8.0 Volts C.T.

$$B = 65,200$$

$$e = 37.2 \times 10^{-6}$$

$$h = 15 \times 10^{-3}$$

$$W/\text{Lb.} = 1.57 + 1.73 = 3.30$$

$$\text{Wt. of Core} = 1.16 \text{ Lbs./in. stack} \times .875'' = 1.015 \text{ lbs.}$$

$$\text{Losses} = 3.30 \times 1.015 = 3.35 \text{ watts}$$

#### Approximate Copper Losses:

$$\text{Watts} = (I_1^2 \times R_{t-1} + I_2^2 \times R_{t-2})$$

$$R_{t-1} = 0.108 \text{ ohms}; R_{t-2} = 412.4 \text{ ohms};$$

$$\text{@ 6.3 V., R.M.S. } I_1 = 3.44 \text{ Amps.};$$

$$\text{R.M.S. } I_2 = 0.0543 \text{ Amps.}$$

$$\text{@ 8.0 V., R.M.S. } I_1 = 4.37 \text{ Amps.};$$

$$\text{R.M.S. } I_2 = 0.069 \text{ Amps.}$$

#### @ 6.3 Volts C.T.

$$W = (1.28 + 1.22)$$

$$= 2.50 \text{ watts}$$

#### @ 8.0 Volts C.T.

$$= (2.06 + 1.96)$$

$$= 4.02 \text{ watts}$$

## No. 2—Sample Design— Vibrator Transformer

**Requirements:** (See Chapter I)

1. To power a deluxe, higher-priced auto radio receiver, for domestic broadcast service; frequency range = 550 to 1600 kc.; IF = 455 kc.
2. Size is important, but performance and quality are of greater significance. However, cost must be controlled and held to a reasonable figure.
3. Output = 260 volts @ 75 Ma., measured at the second filter capacitor (DC meters).
4. Input = 5.90 volts at the transformer primary C.T. (DC meter).  
Input voltage variation = 5.5 to 8.0 volts at the C.T.
5. Self-rectifying vibrator; no rectifier tube required.
6. Vibrator: Self-rectifying Type.
7. Smoothing filter: 10-10 mfd. 450-volt capacitor, with a 4-henry, 200 ohms DC resistance choke connected between capacitor sections. All tubes receive plate voltages from the second filter section (output of filter).
8. B-voltage is at ground potential.
9. All tubes are of the indirectly heated cathode type. A no-load condition, therefore, arises during the starting interval, unless sufficient bleeder resistance is in the circuit to limit no-load voltage.
10. Operation is to be considered as continuous. A fairly high ambient temperature will be encountered under the cowl of the car in the summertime.
11. All of the power supply components will be mounted upon the receiver chassis. The outside case will be small considering the number of tubes, etc., but adequate ventilation is to be provided.

**Calculations:** (Preliminary)

$$\text{Output voltage at 6.3 volts C.T.} = (260 + .075 \times 200) \frac{6.3}{5.9} = 275 \times 1.068 = 294 \text{ v.}$$

$$\text{Output Current at 6.3 Volts C.T.} = .075 \times 1.068 = 0.80 \text{ Amperes}$$

$$\text{Output Watts @ 6.3 Volts C.T.} = .080 \times 294 = 23.5 \text{ Watts (DC meter value)}$$

$$\text{Estimated Efficiency} = 70\%$$

$$\text{Input watts} = \frac{23.5}{.70} = 33.6 \text{ watts}$$

$$\text{Input current} = \frac{33.6}{6.3} = 5.33 \text{ amperes}$$

$$\text{Approximate Maximum Flux Density} = 65,000 \text{ lines per sq. in. @ 8.0 volts C.T.}$$

### Vibrator Characteristics:

(For this Sample Design, the following values are assumed as being representative.)

$$\text{Frequency} = 115 \text{ cycles (average)}$$

$$\text{Time Efficiency (Interrupter)} = .825 \text{ (average)}$$

$$\text{Time Efficiency (Rectifier)} = .750 \text{ (average)}$$

$$\text{Rated Input Voltage} = 6.3 \text{ volts C.T.}$$

$$\text{Rated Input Current} = 6.0 \text{ amperes (max.)}$$

$$\text{Output Voltage @ 6.3 Volts C.T. and Full Load} = 325 \text{ volts DC (max.)}$$

From the above calculations and characteristics, the estimated input current at 6.3 volts C.T. is only 89% of the maximum allowable for reasonable life expectancy. Therefore, this type of vibrator should be satisfactory. The calculated output voltage at 6.3 volts C.T. is 294 volts, full load, which is within the rating given above.

**Calculations:** (Wire size determination):

Using Equation (18):

$$\text{RMS } I_2 = \frac{\sqrt{.750}}{.750} \times .080 = \frac{.866}{.750} \times .080 = 1.155 \times .080 = .0924 \text{ amps.}$$

$$\text{RMS } I_1 = \frac{\sqrt{.825}}{.825} \times 5.33 = \frac{1.101}{.825} \times 5.33 = 5.87 \text{ amps.}$$

Heating Value of  $I_2$  —

$$\text{(Equation 20 and 21)} = .707 \times .0924 = .065 \text{ Amps.}$$

Heating Value of  $I_1$  —

$$\text{(Equation 20 and 21)} = .707 \times 5.87 = 4.15 \text{ Amps.}$$

Assume a tentative value of 750 cm. per ampere current density: (After Equation 21):

Secondary =  $750 \times .065 = 49$  cm. required:

Primary =  $750 \times 4.15 = 3113$  cm. required:

From the table in Figure 26:

Secondary: #33 Wire = 50.4 cm.

#34 Wire = 39.7 cm.

Primary #15 Wire = 3260 cm.

#16 Wire = 2580 cm.

Secondary:

$$\#33 = \frac{50.4}{49} \times 750 = 771 \text{ cm. per ampere}$$

$$\#34 = \frac{39.7}{49} \times 750 = 608 \text{ cm. per ampere}$$

Primary:

$$\#15 = \frac{3260}{3113} \times 750 = 785 \text{ cm. per ampere}$$

$$\#16 = \frac{2580}{3113} \times 750 = 622 \text{ cm. per ampere}$$

Because the operation is at a fairly high voltage and good regulation is to be desired, it appears that the selection should be #15, to be used on the primary, and #34 to be used on the secondary. This is still more apparent when it is realized that the primary must be wound over the secondary because of the primary wire size being used. Even by reversing the order of the windings and using one size smaller wire size on the primary, #17 wire cannot be used, which, as previously stated, is the usual limit for wire that can be wound in multiple coils by automatic machines. Also, #17 wire is the limit for winding the primary inside on the usual sizes of laminations.

**Calculations:** (Turns and Core Determination):

$$\text{Equation (15): } N_1 \times A = \frac{E_1 \times \omega_t \times 10^8}{4 \times B \times K_c \times f}$$

$$N_1 \times A = \frac{8.0 \times .825 \times 10^8}{4 \times .65 \times 10^5 \times .92 \times 1.15 \times 10^2} = \frac{6.60 \times 10^8}{2.75 \times 10^7} = 24$$

Checking in Table of Figure 26:

$$\#15 \text{ E. Wire} = .060 + .007 = .067" \text{ per layer of build.}$$

$$3 \text{ Layers} = 3 \times .067 =$$

$$0.201" \text{ build for primary:}$$

Temporarily estimate that the secondary coil will be equal to that of the primary, or 0.200". The table in Figure 26 shows that .007" Kraft paper is satisfactory for inter-layer insulation for use with #15 wire, and .0015" Glassine paper for use with #34 wire. Also, that for the lamination sizes that can be considered for this unit, a core-tube of .050" thickness will be required. Allow 3 layers of the .007" Kraft paper for wrappers, or .021" thickness.

$$\text{Estimated Total Coil Build} = (.050 + .201 + .201 + .021) = 0.473"$$

See Table of Figure 25:

Window width of EI-12 lamination =

$$0.500" \text{ build} = \frac{.473}{.500} = .946$$

Window width of EI-112 lamination =

$$0.562" \text{ build} = \frac{.473}{.562} = .842$$

Checking in the table of Figure 26:

$$\#15 \text{ E. Wire} = 17 \text{ turns/layer (max.)} = (.060 + .007) = .067"/\text{layer}$$

$$\#34 \text{ E. Wire} = 155 \text{ turns/layer (max.)} = (.0072 + .0015) = .0087"/\text{layer}$$

$$\text{Primary} = 3 \times 17 = 51 \text{ turns (max.) in 3 layers}$$

$$\text{Assume } N_p = 50 \quad N_s = 25$$

$$N_1 \times A = 24 \quad A = \frac{24}{25} = 0.96 \text{ sq. in.}$$

(Apparent area cross-section)

Use a 1" stack of EI-12 laminations = 1.0 sq. in. area

Equation (10):

$$B_m = \frac{8.0 \times .825 \times 10^8}{4 \times 1 \times .92 \times 115 \times 25} = \frac{6.6 \times 10^8}{1.058 \times 10^4} = 62,400 \text{ lines/sq.in. @ 8.0 volts}$$

This will be satisfactory for a preliminary primary and core design.



**Calculations:** (Secondary Determination, and check upon space occupied by the coil):

As an aid in determining the approximate turn ratio needed, assume a regulation factor of 0.70. It is also permissible to assume, temporarily, that the secondary resistance will be:

$$R_t - 2 = R_t \times a^2 \quad (\text{where } a = \text{turn ratio})$$

$$a = \frac{294}{0.70} \times \frac{1}{6.3} = 66.7$$

$$\text{Let } a = 67; a^2 = 4489 \text{ for trial:}$$

Equation (14):

$$E_2 = [E_1 \times a - (I_1 \times R_1 \times a + I_2 R_2)] \omega_t$$

Let  $R_1 = R_{t-1} + R_v$ ; where  $R_v =$   
Vibrator contact resistance (after  
Equation (14));

and substituting  $a^2 R_{t1}$  for  $R_2$  in above.

$$E_2 = [6.3 \times 67 - (5.33 \times 67 \times R_1 + .080 \times 4489 \times R_{t1})] \omega_t$$

When using a self-rectifying vibrator, the value of  $\omega_t$  used is that of the rectifier contacts

$$E_2 = [422 - (357 R_1 + 359 R_{t-1})] 0.75$$

At this point, estimate the  $MLT_p$  and  $R_{t-1}$  of the primary to substitute in the foregoing equation. This involves the secondary build in this instance, since the primary is to be wound over the secondary.

Equation (25):

$$\begin{aligned} MLT_p &= \text{Cir.}_3 + 4P = (\text{Cir.}_1 + 8S + 8W_1 \\ &\quad + 2L) + 4P; \text{ Let } L = 0.10'' \\ &= (2X + 2Y + 8T) + \\ &\quad 8S + 8W_1 + 2L + 4P \\ &= (2.00 + 2.00 + 0.40) + 8 \times 0.20 + \\ &\quad 8 \times 0.01 + 2 \times 0.10 + 4 \times 0.20 \\ &= 4.40 + 1.60 + 0.08 + 0.20 + 0.80 = \\ &\quad 7.08'' \end{aligned}$$

Equation (27):

$$R_{t1} = \frac{N \times MLT \times r}{2 \times 12 \times 1000} = \frac{50 \times 7.08 \times 3.184}{2 \times 12 \times 1000} = 0.047 \text{ ohms/half}$$

where  $r =$  ohms per 1000 feet, from table in Figure 26;

$$R_1 = R_{t1} + R_v = 0.047 + 0.055 = 0.102 \text{ ohms}$$

$$\begin{aligned} E_2 &= [422 - (357 \times .102 + 359 \times .047)] 0.75 \\ &= (422 - 53.3) .75 = 368.7 \times .75 = \\ &\quad 276.5 \text{ volts} \end{aligned}$$

$$\text{Required} = 294 \text{ volts.}$$

$$\text{Therefore revised } a = \frac{294}{276.5} \times 67 = 71.2;$$

$$\text{Try } a = 71; a^2 = 5041$$

The above test showed that the estimated turn ratio is too low and required revision, as shown above. Next determine if the secondary calculated accordingly will fit the space allowable.

Again, #34 E. wire = 155 T/layer (max.)  
= .0087" per layer (including paper)

$$N_s = 50 \times 71 = 3550 \text{ turns required.}$$

$$\frac{3550}{155} = 22.9 \text{ layers required.}$$

$$\text{Secondary coil build} = 24 \times .0087 = 0.209''$$

$$\text{Total coil build} = (.050 + .209 + .201 + .021) = 0.481''$$

$$\% \text{ build} = \frac{0.481}{0.500} = 96.2\%;$$

This is not commercially feasible.

In order to correct this over-build, try reducing the number of secondary layers, rather than reduce any wire sizes, and see what results. The flux density can be allowed to rise somewhat, with the present value being conservative, although a high magnetizing current will probably result.

$$\begin{aligned} \text{Try } 20 \text{ layers of } \#34 \text{ E. wire;} \\ 20 \times 155 = 3100 \text{ turns (max.)} \end{aligned}$$

$$a = 71; N_p = \frac{3100}{71} = 43.7 \text{ turns; or } 44 \text{ turns}$$

$$a = \frac{3100}{44} = 70.5 \quad a^2 = 4970$$

$$\text{Secondary coil build} = 20 \times .0087 = 0.174'' \text{ vs. } 0.209''$$

$$\text{Total coil build} = (.050 + 1.74 + .201 + .021) = 0.446''$$

$$\% \text{ build} = \frac{0.446}{0.500} = 89.2\%$$

$$\text{Clearance} = .054'' \text{ or } 10.8\%$$

This clearance might be satisfactory for the size laminations being considered. However, winding #15 wire may result in some bulging of the coil, which might have to be shaped before assembly could be made.

$$\text{Revised } B_m = \frac{50}{44} \times 62,400 = 70,900 \text{ lines per sq. in.}$$

This flux density is close to the saturation region and the smaller number of primary turns, combined with the high flux density and longer length of magnetic path, will result in a rather high peak magnetizing current. This is not desirable from several standpoints and this design would be considered unsatisfactory.

### Remarks on Design:

Two alternatives are apparent as means for improving the above design:

1. The primary wire size can be changed to #16 instead of #15, which will occupy less window space if 3 layers are maintained. The reduction equals  $3 \times (.0598 - .0531) = 3 \times .0057 = .017"$ . This reduction in build permits the use of two more layers of #34 wire on the secondary without increasing the overall coil build. This is an increase of 310 turns, or a new total of 3410 maximum.

With  $a = 71$  (approx.),

$$N_p = \frac{3410}{71} = 48; \text{ Let } N_p = 48$$

$$a^2 = 5041$$

$$B_m = \frac{44}{48} \times 70,900 = 65,000 \text{ lines per sq. in.}$$

This change permits the use of 48 primary turns (of smaller wire), and a satisfactory reduction in flux density, and still maintains a reasonably small core size. However, the regulation and heating will be poor and the overall design will not be as good as the second alternative.

2. The second alternative is to use the EI-112 lamination. The table in Figure 25 shows this to be a larger overall size, with an additional window length of  $0.1875"$  and an additional window width of  $.0625"$ . This will accommodate larger

wire sizes and more turns. The center-leg width is  $1.125"$  and will result in a smaller stack than would the first alternative.

The choice between the two alternatives depends somewhat upon the circumstances surrounding the individual case. Generally, with everything else equal, the choice should be in favor of the larger lamination.

### Calculations: (Using Alternative No. 1)

$$a = 71; N_p = 48; N_s = 3410$$

$$\text{MLT}_s = \text{Cir.}_1 + 4S = 4.40 + (4 \times .191) = 5.16"$$

$$R_{t2} = \frac{3410 \times 5.16 \times 261}{2 \times 12 \times 1000} = 191 \text{ ohms per half}$$

$$\begin{aligned} \text{MLT}_p &= \text{Cir.}_3 + 4P = (4.40 + 8 \times .191 + 8 \times .01 + 2 \times .1) + 4 \times .180 \\ &= 4.40 + 1.53 + .08 + .2 + .72 = 6.93" \end{aligned}$$

$$R_{t1} = \frac{48 \times 6.93 \times 4.016}{2 \times 12 \times 1000} = .057 \text{ ohms per half}$$

$$R_1 = .057 + .055 = .112 \text{ ohms}$$

Solving for  $E_2$ :

$$\begin{aligned} E_2 &= [(6.3 \times 71) - (71 \times 5.33 \times .112) + (.080 \times 191)] \times 0.75 \\ &= [447 - (42.4 + 15.3)] \times .75 \\ &= 419.9 \times .75 = 315 \text{ volts.} \end{aligned}$$

Required 294 volts.

Revision of turn ratio:

$$a = \frac{294}{315} \times 71 = 66$$

$$N_s = 48 \times 66 = 3168 \text{ or } 3170 \text{ turns}$$

#34 E. wire

$$R_2 = \frac{3170}{3410} \times 191 = 178 \text{ ohms}$$

$$B_m = \frac{8.0 \times .825 \times 10^8}{4 \times 24 \times 1 \times .92 \times 115} = 65,000 \text{ lines per sq. in.}$$

This revised design appears to be fairly satisfactory and may be tried. However, a slightly better design could be secured on the basis of using the EI-112 lamination.

### Specifications: (Using Alternative No. 1)

Core: 1" stack of EI-12 lamination; #24 ga. dynamo grade, or equivalent; laminations to be inter-leaved in groups of  $2 \times 2$ , or less.

Core Tube: .050" thick, built-up from gummed-Kraft paper, or equivalent.

Secondary: 3170 turns of #34 E. wire, tapped at 1585 turns. Tolerance on number of turns = + or - 1%. 22 layers with .0015" Glassine paper between layers.

Secondary Wrapper: 2 layers of .007" gummed Kraft paper.

Primary: (To be wound over the secondary): 48 turns of #16 E. wire, tapped at 24 turns. Tolerance on number of turns and tap location = + or -0; 3 layers, with .007" Kraft paper between layers.

Outer Wrapper: 1 layer of .007" gummed Kraft paper, in addition to the 1 layer included as a part of the 3rd primary layer in the foregoing calculations; or equivalent fiber, etc.

Leads or Terminals: As required by the application and/or mounting scheme.

### Final Notes:

1. This method of calculation is rather conservative, and probably will result in a turn ratio which will develop an output voltage that is higher than is desired. This is desirable in order that any changes necessary after a sample has been built and tested will not involve the use of a greater window area. Thus lamination dimensions will not require changing.

Should a correction in output voltage be necessary, it is accomplished by the simple expedient of reducing the number of secondary turns by the ratio of the desired voltage to the measured voltage.

Experience has shown that transformer designs using self-rectifying vibrators are more conservative than those using interrupter vibrators when following the foregoing procedures in detail. It has been proven that the use of the interrupter contact time efficiency, regardless of the type of vibrator to be used, will result in an actual output voltage nearer to the desired value. Therefore, in subsequent sample designs in this text, the interrupter contact time efficiency will be used.

2. The sample transformers should be tested with a representative number of typical vibrators in order to secure an average output condition. This is also necessary in order to determine the correct timing capacitance, as will be discussed in a later chapter. Both tests may be carried out simultaneously.

3. Other differences in the final output voltage achieved may result from the permissible variations in vibrators from rated averages. These may appear as variations in time efficiencies of both the interrupter and rectifier, frequency, and contact resistance.

**Supplementary Calculations:** Determination of Magnetizing Currents (peak values):

Equation from Chapter VII:

$$i_m = \frac{H \times L}{N_1} = \text{amps. (peak)}$$

$$L = 6.0" \text{ (see Figure 25);}$$

$$H = \text{(from Figure 30);}$$

$$N_1 = 24 \text{ turns}$$

### @ 6.3 Volts C.T.

$$B = 51,200 \text{ L./sq.in.}$$

$$H = 2.60 \text{ amp.T./inch}$$

$$i_m = 0.650 \text{ amperes (peak)}$$

$$\text{Voltage ratio} = \frac{8.0}{6.3} = 1.27$$

### @ 8.0 Volts C.T.

$$B = 65,000 \text{ L./sq.in.}$$

$$H = 4.0 \text{ amp.T./inch}$$

$$i_m = 1.0 \text{ amperes (peak)}$$

$$\text{Current ratio} = \frac{1.0}{0.650} = 1.54$$

**Approximate Core Losses:** (Equations, from Chapter VII, Curves, Figures 34 and 35, Table in Figure 25, Chapter VII).

Watts per pound =  $(4.22 \times 10^4 x e) + (115 \times h)$ ; for 115 cy/s. & #24 ga.

**@ 6.3 Volts C.T.**

$$B = 51,200$$

$$e = 24.8 \times 10^{-6}$$

$$h = 9.8 \times 10^{-3}$$

$$W/Lb. = 1.05 + 1.13 = 2.18 \text{ watts}$$

$$\text{Losses} = 2.18 \times 1.52 = 3.31 \text{ watts}$$

**@ 8.0 Volts C.T.**

$$B = 65,00$$

$$e = 37 \times 10^{-6}$$

$$h = 14.9 \times 10^{-3}$$

$$W/Lb. = 1.56 + 1.71 = 3.27 \text{ watts}$$

$$\text{Losses} = 3.27 \times 1.52 = 4.97 \text{ watts}$$

Weight of 1" stack of EI-112 laminations  
(see table of Figure 25): 1.52# per inch.

**Approximate Copper Losses:**

$$\text{Watts} = (I_1^2 \times R_{t-1} + I_2^2 \times R_{t-2})$$

Where I = RMS value;

$$R_{t-1} = 0.057 \text{ ohms}; R_{t-2} = 178 \text{ ohms};$$

$$\text{@ 6.3 volts, RMS } I_1 = 5.87 \text{ amperes};$$

$$\text{RMS } I_2 = 0.0924 \text{ amperes};$$

$$\text{@ 8.0 volts, RMS } I_1 = 7.45 \text{ amperes};$$

$$\text{RMS } I_2 = 0.117 \text{ amperes};$$

**@ 6.3 Volts C.T.**

$$\text{Watts} = (1.96 + 1.52)$$

$$\text{Losses} = 3.48 \text{ watts}$$

**@ 8.0 Volts C.T.**

$$\text{Watts} = (3.16 + 2.44)$$

$$\text{Losses} = 5.60 \text{ watts}$$

**II. Low Output 6-Volt Power Units**

When the application of the vibrator power supply unit is such that the battery supplying the input energy is not being charged during the operation of the equipment, an entirely different conception of design characteristics should be employed. The previous discussion has dealt with auto radio receiver power units, where the battery was used in conjunction with a charging system, and where input current drain was not of paramount importance.

Also, the output power was reasonably high, which permitted the use of a design incorporating fairly high losses without too great a reduction in efficiency.

In the operation of battery-operated home radio receivers, such as the so-called "farm sets," or in portable receivers, the battery supplying the input energy must be removed from the receiver and taken to a charging station, or some similar provision made for periodically charging it. Or, if the unit operates from heavy-duty dry batteries, these must be replaced when discharged. This means that the input current in this type of application is of maximum importance and the design must be considered with this in mind. The number of hours of operation per month, or year, will also be higher for equipment of this type than for the average auto receiver. Therefore, performance and life of the vibrator is of equal importance. Size and cost are much less important as compared to auto-radio receivers.

The following observations can be made in making a general comparison of the low-output units with the auto-radio units just discussed. Since the battery is not on charge, the highest operating voltage is that of a fully-charged battery with a small amount of load impressed upon it. A value of 6.4 volts should be sufficiently high for this purpose. (Where receivers operate with a "Windcharger," or similar device, connected to the battery, the power supply system must be given the same consideration as for automotive applications.) The lowest input voltage will be that of a completely discharged battery, with the normal primary circuit voltage-drop subtracted from it. A value of 5.5 volts at the transformer C.T. would be satisfactory for these calculations. Therefore, it can be easily seen that the range of voltages is much less than for an equivalent automobile battery, the value in this case being 1.16 as against 1.48 for the typical automobile receiver.

The above observation on the range of input voltage leads to the consideration of the proper maximum flux-density compared to the previous calculations. Because the voltage range is small, a very

high flux-density could be used and yet the timing capacitor matching would be fairly good for the whole range. However, high flux-density involves high core-losses and high magnetizing current. As has been pointed out, the magnetizing current comes from the battery and is therefore included as part of the average battery current. Since battery drain of the lowest practical value is important, anything that can be done to reduce this loss is desirable. Therefore, for this class of service, low flux-densities are desirable, and a value in the region between 30,000 and 45,000 lines per square inch for the highest input voltage is considered good design practice.

The choice between using a comparatively large core cross-section with a small number of turns of large wire and a smaller core cross-section with a large number of turns of smaller wire always arises in determining such a design. With the latter arrangement the magnetizing current for a given flux-density will be much lower than it would be for the former. The weight of steel will be reduced, and thus the core-losses will be lower. In contrast, the regulation will be poorer, and the copper-losses will increase. Since regulation is usually of only minor importance, it can be subordinated in these considerations. Usually the copper-losses do not increase quite as much as the combination of core-losses and magnetizing current decrease, especially when one considers that the mean length of turn of the coils decreases with the reduction of core cross-section.

The choice of current-density for use in the windings is allied with the preceding decision. Except where an absolute minimum in size is required, the use of 750 to 1000 circular-mils per ampere should suffice. Where extremely small sizes are involved, such as #40 or smaller, it is quite often desirable and less costly to use higher than 1000 CM/amp. rather than use such small wire that winding and handling difficulties increase production troubles. Where extremely small size must be attained, values down to 500 CM/amp. may be used, but with the penalty of increased losses. At the low output handled, heating is not likely to be important.

As a general rule, self-rectifying vibrators are used in such applications. This is done to eliminate the battery drain of a rectifier tube of the high-vacuum type, although new ionically-heated types suitable for low output powers are now available. The elimination of the plate voltage-drop also increases the overall efficiency of the system when the self-rectifying type is used. However, where the receiver design is made with the thought in mind of providing for conversion to "high-line" service when alternating current circuits are available, the efficiency of the design is sacrificed somewhat and a rectifier tube is provided. In this case the power transformer also must provide for a suitable high-voltage AC sine wave primary.

### **III. Low Output 2-Volt and 4-Volt Power Units** •

Some 4-volt input vibrator power supply units have been manufactured in the past, but they are more or less obsolete except for special services. The complete receiver operated from a 6-volt battery, with the tube filaments (of the 2-volt filament type) operating from one cell and the power supply unit operating from the other two cells of the battery. Thus the battery could be procured as a standard automobile type, and charged as a regular 6-volt unit. The filament circuit was free from vibrator-hum modulation. The B-circuit could be placed 4 volts negative from the filament "ground," to supply negative bias for the receiver, when a standard single-reed self-rectifying vibrator was used. Some 4-volt units are used to power special portable test equipment, such as megohmmeters where high voltage is desired. Most of the low voltage applications, however, have now shifted to 2.0 volts input. These consist of power supply units for portable receivers, where a small non-spillable lead-acid storage-battery is used to operate both the 1.4 or 2.0 volt type of miniature tube and the vibrator supply. On AC operation, a switch provides means for charging the battery at a rate usually equivalent to the discharge into the receiver. The

switch also provides for charging the battery with the receiver turned off.

The same characteristics that are important for the low-power output 6-volt power supplies are progressively more important for the 4-volt and the 2-volt units. If the usual 6-volt transformer design were to be converted to a 2-volt operation, the primary turns would be reduced in number to one-third of the original number. This would mean that the peak magnetizing current value would be increased by three times for the same value of flux-density and the same size of lamination as used previously. This certainly would decrease the overall efficiency and raise the battery current drain, which is to be avoided. Therefore, a different approach to the design should be used than was used for the 6-volt unit.

In order to keep the length of magnetic path short, as an aid in holding down the magnetizing current, the laminations size should be chosen as small as is practicable with consideration given to the other design factors. This can often be helped by using a larger stack of laminations which will result in a rectangular winding form. Ordinarily this is to be avoided for production reasons, as has been pointed out, but in this special case, to achieve a definite result, a greater deviation from the square cross-section can be tolerated. This is also possible where the wire sizes involved are small.

The best design would be with a comparatively low maximum flux-density, and using the best grade of commercial transformer steel for the core. This would usually mean Allegheny-Ludlum Transformer "A" grade, or the equivalent, in #29 gauge. Examination of the B-H curves in Figures 27 to 30 for values of  $B=30,000$  shows that the values of "H" for steel grades "A," "C" and "Dynamo," respectively, are 1.25, 1.72 and 1.64 ampere-turns per inch of magnetic path. The change in grade alone, from the "Dynamo" of the 6-volt transformer to the grade "A" of the 2-volt design, for the same flux-density, results in a decrease in magnetizing current of 24% for the peak value,  $i_m$  for Grade "A" being 76% of that for "Dy-

namo." In addition, the core-losses will be reduced through the change in grades, and further reduced by the reduction in gauge of the laminations.

In most cases, the vibrator used is of the self-rectifying type, although again one of the newer ionically-heated rectifier tubes may be used. If some heater power is required to operate the rectifier, this can be obtained only by a small additional winding upon the vibrator transformer. Because of the difficulty of maintaining good amplitude of the vibrator with a minimum of driving coil power (which is desirable in order to hold the fixed losses at a minimum), and because the shunt-connected driving coil obtains its coil-current through one-half of the primary winding, the separately-driven type of vibrator mechanism is universally used for the 2-volt supplies.

If the driving coil current passes through one-half of the primary winding while the opposite half is conducting load current, the one tends to neutralize the other, resulting in an unbalanced magnetic condition in the two halves of the cycle. At 4-volt operating conditions this effect is slightly apparent, but of little consequence. At higher voltages it is negligible. However, at 2-volts input, the coil current is an appreciable part of the load current for the loads usually used, and the unbalance is rather high, and therefore, is undesirable.

The driving-coil current, even with specially designed components, is still rather high and care must be given to proper circuit conditions and contact materials in order that the driving system functions properly over the life of the power contacts. In addition to the structural and material changes of the core, the winding design must also be changed if the best all-around design is to be obtained. As has already been pointed out, it is desirable to keep the number of primary turns high. As the amount of copper that can be properly accommodated in the window of a given lamination size is fixed, too great an increase in the number of turns will result in an increase in the core size, and the reduction in the size of the conductor is limited by the allowable current-density already determined and therefore, only a limited

additional number of turns can be secured in this manner.

While it is usually desirable to keep an approximately equal division of the transformer losses, such that the copper-loss equals the core-loss, in this instance it is usually permissible to intentionally increase the percentage of the copper-loss by using smaller sizes of wire and more turns. This action helps to accomplish the results outlined in the previous paragraphs. Normally, copper cross-sectional areas which will provide more than 750 circular-mils per ampere are desirable. If the occasion demands a value of less than 750, then values down to 500 CM/amp. could be used.

The following sample design (No. 3), illustrates one method of making such a 2-volt transformer design, in a minimum of overall size and with a reasonable efficiency and regulation.

### No. 3—Sample Design— Vibrator Transformer

**Requirements:** (See Chapter I):

1. To power a portable, single-unit radio receiver, for domestic broadcast reception. To operate from self-contained battery and 115-volt, 60-cycle power line. Frequency range = 550 to 1600 kc. IF = 455 kc.
2. Efficiency and performance of the power supply are most important, with the size and cost of relatively secondary importance.
3. Output: 90 volts @ 15 Ma., measured at the 2nd filter capacitor (DC meters).
4. Input: 1.90 volts at the transformer CT (DC meters). Input voltage variation from 1.70 to 2.20 volts @ the CT. The operation on an AC line consists of connecting a suitable dry-disc charger to the battery to maintain the charge in the battery during operation.
5. Self-rectifying vibrator is used; no rectifier tube is required.
6. Vibrator: 2-Volt, Self-rectifying Type.
7. Smoothing filter: 20-20 mfd., 150 volts, capacitor, with 4 henry, 400 ohm DC

resistance choke connected between capacitor sections. All tubes receive plate voltages from the output of the filter.

8. B - voltage is at ground potential.
9. All tubes are of the filament type, and therefore, no no-load conditions exist at the start. A filter in the filament circuit will be required to act as a hum-filter for suppressing vibrator-frequency modulation effects.
10. Operation is considered continuous, but ambient temperatures will be very low.
11. Power supply unit will be enclosed in a separate compartment. Because of the low power being handled, little ventilation is required.

**Calculation:** (Preliminary):

Output voltage @ 2.0 volts CT. =

$$(90 + .012 \times 400) \times \frac{2.0}{1.9} = 94.8 \times 1.053 = 99.8 \text{ volts}$$

Output current @ 2.0 volts CT. =

$$.015 \times 1.053 = .0158 \text{ amperes}$$

Output watts @ 2.0 volts CT. =

$$99.8 \times .0158 = 1.58 \text{ watts}$$

Estimated efficiency = 50% of the output required

$$\text{Input watts} = \frac{1.58}{0.50} = 3.16 \text{ watts (est.)}$$

$$\text{Input current} = \frac{3.16}{2.0} = 1.58 \text{ amperes}$$

Approximate maximum flux-density = 50,000 lines per sq. in. @ 2.20 volts, CT.

**Vibrator Characteristics:** (For this sample design, the following values are ASSUMED as being representative):

Frequency = 115 cycles (average)

Time efficiency (interrupter) = 0.825 (av.)

Time efficiency (rectifier) = 0.75 (av.)

Rated input voltage = 2.00 volts CT.

Rated input current = 2.00 Amperes (max.)

Output voltage @ 2.0 volts CT. and full load = 250 volts DC (maximum)

From the above calculations and characteristics, it will be noted that the estimated input current at 2.0 volts CT, is well within the maximum value allowable for reasonable life expectancy. Therefore, this type of vibrator would be satisfactory for the application. The maximum full load output voltage is also well below the allowable value.

**Calculations:** (Wire size determination):

Using Equation (18):

$$\text{RMS } I_2 = \frac{\sqrt{.75}}{.75} \times .0158 = 1.155 \times .0158 = .0182 \text{ amperes}$$

$$\text{RMS } I_1 = \frac{\sqrt{.825}}{.825} \times 1.58 = 1.10 \times 1.58 = 1.74 \text{ amperes}$$

$$\text{Heating value } I_2 = .707 \times .0182 = .0129 \text{ amperes}$$

$$\text{Heating value } I_1 = .707 \times 1.74 = 1.23 \text{ amperes}$$

Assume a tentative value of 700 cm./amp. current density:

$$\text{Secondary} = 700 \times .0129 = 9.03 \text{ cm. required;}$$

$$\text{Primary} = 700 \times 1.23 = 861 \text{ cm. required.}$$

From the table in Figure 26:

$$\text{Secondary} = \#41 = 7.84 \text{ cm.} \quad \#40 = 9.61 \text{ cm.}$$

$$\text{Primary} = \#21 = 812 \text{ cm.} \quad \#20 = 1020 \text{ cm.}$$

Secondary:

$$\#40 = \frac{9.61}{9.03} \times 700 = 745 \text{ cm./amp.}$$

$$\#41 = \frac{7.84}{9.03} \times 700 = 608 \text{ cm./amp.}$$

Primary:

$$\#21 = \frac{812}{861} \times 700 = 660 \text{ cm./amp.}$$

$$\#20 = \frac{1020}{861} \times 700 = 829 \text{ cm./amp.}$$

Try using #21 on the primary winding, and #40 on the secondary winding, to accomplish the aims outlined in the text for such a design as this.

**Calculations:** (Primary turns and core determination):

Equation (15):

$$N_1 \times A = \frac{E_1 \times \omega t \times 10^8}{4 \times B \times K_c \times f}$$

$$N_1 \times A = \frac{2.2 \times 0.825 \times 10^8}{4 \times 50 \times 10^3 \times .92 \times 115} = \frac{1.82 \times 10^8}{2.12 \times 10^7} = 8.58$$

Checking in the table of Figure 26:

$$\#21 \text{ E. wire} = (.0305 + .004) = .0345" \text{ per layer}$$

$$\#40 \text{ E. wire} = (.0037 + .0007) = .0044" \text{ per layer}$$

By the observation of overall dimensions, area of the window and center-leg width, the EI-625 lamination size would appear to be desirable as the maximum size in which to incorporate this design. This size may now be tried for fit.

$$\#21 \text{ E wire} = 22 \text{ turns per layer}$$

$$\#40 \text{ E wire} = 186 \text{ turns per layer}$$

Allowable coil build (wire and paper only) = 0.220" for both windings

Approximate build per winding =

$$\frac{.220}{2} = 0.110"$$

Allowable primary layers =

$$\frac{0.110}{.0345} = 3.2; 3 \times .0345 = 0.1035"$$

Max.  $N_p = 3 \times 22 = 66 \text{ T.}$  Allowing for automatic winding, subtract one turn per layer (2 turns should be sufficient subtraction)

$$N_p = 64 \text{ turns; } N_1 = 32 \text{ turns, } N_1 \times A = 8.58$$

$$A = \frac{8.58}{32} = 0.268 \text{ sq. in. cross-section, center-leg (apparent)}$$

$$\text{Stack} = \frac{0.268}{0.625} = 0.429"; A \frac{3}{8}" \text{ stack} = .625 \times .625 = 0.391 \text{ sq.in.}$$

The use of a  $\frac{3}{8}"$  Stack of EI-625 would appear satisfactory with a primary winding of 3 layers of #21, of 64 turns total.

$$\text{Coil build left for secondary} = (.220 - .1035) = 0.1165"$$



$$B_{max} = \frac{2.2 \times .825 \times 10^8}{4 \times 32 \times .92 \times .391 \times 115} = \frac{1.82 \times 10^8}{5.30 \times 10^3} = 34,300 \text{ L/sq.in.}$$

**Calculations:** (Secondary determination, and check upon the space occupied by the coil):

As an aid in determining the approximate turn-ratio needed, assume a regulation factor of 0.80. (The vibrator contacts—interrupter—are of precious-metal alloy, with negligible contact resistance compared with that of the higher-voltage vibrators).

$$\text{Estimated } a = \frac{99.8}{0.8 \times 2.0} = \frac{125}{2.0} = 62.5$$

$$a^2 = 3906$$

To illustrate a different approach from that used in previous samples:

$N_s = 62.5 \times 64 = 4000$  T. #40 E. wire;

$$\frac{4000}{186} = 21.5 \text{ layers;}$$

22 layers =  $22 \times 186 = 4092$  or 4090 maximum =  $22 \times .0044 = .097''$  build

Total coil build =  $(.1035 + .097 + .035 + .016) = .252$

% Coil build =  $\frac{.252}{.312} = .808$  or 80.8%

Clearance = .060

This coil build is very conservative and it appears that a larger wire size could be used at least on the primary winding, to reduce the IR drop therein. Therefore, try #20 wire for the primary.

Coil build =  $3 \times .039 = 0.117''$ ;

#20 = 19 turns per layer

$N_p = 3 \times 19 = 57$  turns (max.) in 3 layers; we will use 54 turns allowing for automatic winding.

Total coil build =  $(.035 + .117 + .097 + .016) = 0.265''$

% Coil build =  $\frac{0.265}{0.312} = .849$  or 84.9%

Clearance = .047''

This coil build is still conservative and should be very satisfactory.

**Calculations:** (Redesign based upon new wire size and turns):

$N_p = 54$  turns;

$B_m = \frac{32}{27} \times 34,300 = 40,600$  L/sq.in.

$N_s = 54 \times 62.5 = 3375$  turns #40;

$\frac{3375}{186} = 18.1$  layers;

$18 \times 186 = 3350$  Max.

$a = \frac{3350}{54} = 62$  for 18 layers maximum

Build =  $18 \times .0044 = .079''$

Total coil build =  $(.117 + .079 + .035 + .016) = .247'' = .79$  or 79% build

$MLT_p = (2 \times .625) + (2 \times .625) + (8 \times .035) + (4 \times .117) = 2.780 + .468 = 3.248''$

$MLT_s = 2.78 + .468 + .08 + .20 + (4 \times .079) = 3.844''$

$R_{t-1} = \frac{54 \times 3.25 \times 10.15}{2 \times 12 \times 1000} = .074$  ohms per half

$R_{t-2} = \frac{3350 \times 3.84 \times 1049}{2 \times 12 \times 1000} = 562$  ohms per half

$E_2 = [2.0 \times 62 - (1.58 \times .074 \times 62 + .0158 \times 562)] .825$   
 $= [124 - (7.2 + 8.9)] .825$   
 $= (124 - 16.1) .825 = 107.9 \times .825 = 89.0$  volts

$E_2$  required = 99.8 volts

Revised  $a = \frac{99.8}{89.8} \times 62 = 69.5$ ;

$N_s = 69.5 \times 54 = 3750$  T. #40

Layers =  $\frac{3750}{186} = 20.2$  layers;

$22 \times .0044 = .097''$  build

Total coil build =  $(.117 + .097 + .035 + .016) = .265 = 84.9\%$

$R_{t1} = 0.074$  ohms per half

$MLT_s = 2.78 + .468 + .08 + .20 + (4 \times .097) = 3.916''$

$R_{t2} = \frac{3750 \times 3.92 \times 1049}{2 \times 12 \times 1000} = 643$  ohms

$E_2 = [2 \times 69.5 - (1.58 \times .074 \times 69.5 + .0158 \times 643)] .825$   
 $= [139 - (8.1 + 10.2)] \times .825$   
 $= 120.7 \times .825 = 99.6$  volts

**NOTE:** The test specifications may be varied, if the supplier would rather handle the #39 size of wire, and work with the somewhat smaller clearance then available.

### Specifications:

**Core:**  $\frac{3}{8}$ " stack of EI-625 laminations; #29 ga., transformer "A" grade, or equivalent. Laminations to be interleaved in groups of  $2 \times 2$ , or less.

**Core Tube:** .035" thick, built-up from gummed Kraft paper, or equivalent.

**Primary:** 54 turns of #20 E. wire, tapped at 27 turns. Tolerance on number of turns and tap = + or -0. Three layers, with .004" Kraft paper between layers.

**Primary Wrapper:** 2 layers of .004" gummed Kraft paper, in addition to the 3rd-layer paper included in the primary calculations.

**Secondary:** (To be wound over the primary): 3750 turns of #40 E. wire, tapped at 1875 turns. Tolerance on turns = + or - 1%. 22 layers, with .0007" glassine paper between layers. (.001" glassine paper could be used in build available, if desired).

**Outer Wrapper:** 2 layers of .004" gummed Kraft paper, or equivalent.

**Leads or Terminals:** As required by the application and/or mounting.

### Final Notes:

1. This method of calculation is rather conservative, and probably will result in a turn ratio which will develop an output voltage that is higher than desired. This is desirable in order that any changes necessary after a sample has been built and tested will not involve the use of a greater window area. Thus, lamination dimensions will not require changing. Should a correction in output voltage be necessary, it is accomplished by the simple expedient of reducing the number of secondary turns by the ratio of the desired voltage to the measured voltage.
2. The sample transformer should be tested with a representative number of typical

vibrators in order to secure an average output condition. This is necessary in order to establish the correct value of timing capacity, as will be discussed in a later chapter. Both tests may be carried out simultaneously.

3. Other differences in the final output voltage achieved may result from the several variations possible in the vibrators themselves.

**Supplementary Calculations:** (Determination of magnetizing currents—peak values):

Equation from Chapter VII:

$$i_m = \frac{H \times l}{N_1} = \text{amps. (peak)}$$

$$l = 3.75" \text{ (See Figure 25)}$$

$$H = \text{(From Figure 27)}$$

$$N_1 = 27 \text{ turns}$$

**@ 1.90 Volts C.T.**

$$B = 35,100 \text{ L/sq.in.}$$

$$H = 1.5 \text{ amp.T./inch}$$

$$i_m = 0.208 \text{ amperes (peak)}$$

$$\text{Voltage ratio: } \frac{2.2}{1.9} = 1.16$$

**@ 2.20 Volts C.T.**

$$B = 40,600 \text{ L/sq.in.}$$

$$H = 1.7 \text{ amp.T./inch}$$

$$i_m = 0.236 \text{ amperes (peak)}$$

$$\text{Current ratio: } \frac{.236}{.208} = 1.13$$

**Approximate Core Losses:** (Equations, from Chapter VII; Curves, Figures 34 and 35, Table in Figure 25 of Chapter VII).

Watts per pound =  $(1.322 \times 10^4 \times e) + (115 \times h)$ , for 115 cycles and #29 ga.

**@ 1.90 Volts C.T.**

$$B = 35,100$$

$$e = 10.8 \times 10^{-6}$$

$$h = 2.85 \times 10^{-3}$$

$$W/lb. = (.143 + .328) = .471$$

$$\text{Losses} = .471 (.598 \times 6.25) = .179 \text{ watts}$$

**@ 2.20 Volts C.T.**

$B = 40,600$   
 $e = 13.9 \times 10^{-6}$   
 $h = 3.6 \times 10^{-3}$   
 $W/lb. = (.184 + .414) = .598$   
 Losses = .598 (.598  $\times$  .625) = .224 watts  
 Weight per inch, EI-625 = 0.598 lbs.

**Approximate Copper Losses:**

$$\text{Watts} = (I_1^2 \times R_{t1} + I_2^2 \times R_{t2})$$

Where I = RMS value

$$W_t = 0.825; R_{t1} = .074 \text{ ohms}; R_{t2} = 643 \text{ ohms}$$

@ 1.90 volts CT:

$$\text{RMS } I_1 = 1.65 \text{ amps}; \text{RMS } I_2 = .0173 \text{ amps}$$

@ 2.20 volts CT:

$$\text{RMS } I_1 = 1.91 \text{ amps}; \text{RMS } I_2 = .020 \text{ amps}$$

**@ 1.90 Volts C.T.**

$$\begin{aligned} \text{Watts} &= (.201 + .192) \\ &= 0.393 \text{ watts} \end{aligned}$$

**@ 2.20 Volts C.T.**

$$\begin{aligned} \text{Watts} &= (.270 + .257) \\ &= .527 \text{ watt} \end{aligned}$$

**Contrast of the Above Magnetic Characteristics to Those Assuming #24 Ga. Dynamo Grade:**

(Determination of Magnetizing Currents):  
Figure 30.

**@ 1.90 Volts C.T.**

$B = 35,100$   
 $H = 1.80$   
 $i_m = .250$   
 Voltage ratio = 1.16

**@ 2.20 Volts C.T.**

$B = 40,600$   
 $H = 2$   
 $i_m = .278$   
 Current ratio = 1.11

**Approximate Core Losses:**

$$\text{Watts/lb.} = (4.22 \times 10^4 \times e) + (115 \times h)$$

**@ 1.90 Volts C.T.**

$B = 35,100$   
 $e = 12.7 \times 10^{-6}$   
 $h = 4.9 \times 10^{-3}$   
 $\text{Watts/\#} = (.536 + .564) = 1.101$   
 Losses = .374  $\times$  1.101 = .411 watts

**@ 2.20 Volts C.T.**

$B = 40,600$   
 $e = 16 \times 10^{-6}$   
 $h = 6.25 \times 10^{-3}$   
 $\text{Watts/\#} = (.675 + .719) = 1.394$   
 Losses = .374  $\times$  1.394 = .521 watts

**Ratio of Increase Using Dynamo:**

(For the  $B_m$  and thickness used):

$$i_m: \frac{.250}{.208} = 1.20 \text{ X} \quad \frac{.278}{.236} = 1.18 \text{ X}$$

$$W_{cl} = \frac{.411}{.179} = 2.3 \text{ X} \quad \frac{.521}{.224} = 2.33 \text{ X}$$

**IV. Twelve-Volt, 24-Volt and 32-Volt Power Units**

When first considered, it would appear that the operation of a vibrator power supply at the higher input voltages would eliminate most of the difficulties encountered at the 6-volt and lower voltages and thus simplify the design of such units. These units are almost always used in mobile equipment, except for the 32-volt type which may be employed for 32-volt stationary systems such as are used on farm or rural locations and in some marine applications.

The average 12 and 24-volt battery system on trucks, busses, aircraft, and so on, is well regulated in so far as the charging system is concerned, furnishing a narrow range of operating voltages. The 32-volt marine installation is usually not regulated as carefully, but is better than that of the usual farm installation, which is considered the worst of the higher voltage installations in so far as voltage range is concerned. The nominal 12-volt system can be expected to vary from 10 to 15 volts under

usual conditions. In the same manner, the nominal 24-volt system will vary from 20 to 30 volts. Nominal 32-volt systems must be expected to vary from 27 to 40 volts, although instances have been noted where this variation has been from 20 to 48 volts. Poorly arranged locations of battery with respect to the generator and load, lengths of wiring, etc., will affect such systems adversely.

Because the loads upon such power supply units are, in general, approximately the same as for lower voltage input units, the primary current commutated by the vibrator is usually of a considerably smaller value than exists at the lower voltage. Thus, the usual 12-volt unit normally draws approximately one-half the input current as that drawn by a 6-volt unit of the same characteristics. The 24-volt unit would commute about one-fourth of the current, and so on. With this in mind, the life of the vibrators, as affected by the load current handled, can be expected to be somewhat greater. Also, the effects of the primary circuit "IR" voltage drops will be greatly reduced and even made negligible since the percentage of the drop to the available battery voltage will vary inversely as the square of the ratio of increase in voltage. Thus, cutting the current in half by changing from 6 volts to 12 volts reduced the "IR" drop by one-half (assuming the same primary resistance). This reduces the effect to one-quarter. At 24 volts input, the effect is reduced to one-sixteenth of that at 6 volts. The above, of course, refers to the external primary circuit, and not to the primary winding of the transformer.

If the output power requirements are approximately the same as for the 6-volt condition, the wire sizes required for the primary windings of the transformers will be progressively reduced with an increase in input voltage. Thus for a 12-volt input, the wire used would normally be three sizes smaller than for 6 volts; for 24 volts it would be six sizes smaller, while for 32 volts it would be roughly seven sizes smaller. One can immediately see the significance of this in the greater freedom in choice of the numbers of layers used in the

primary, the ability to bring out the primary center-tap at the end of a layer rather than at the middle of one, and in the ease of winding the primary inside or outside of the secondary as desired.

If all other factors remained the same, these changes would indeed aid in simplifying the designs. However, an electro-physical phenomenon occurs at these higher voltages which requires special technique in transformer design to overcome difficulties in vibrator operation. This phenomenon relates to the ionization voltage of the air present between the contacts. This voltage varies somewhat for various mixtures of the gases that compose the atmosphere. For this discussion it can be safely assumed that a value of between 14.0 and 14.4 volts is correct. This means that if an arc is established when the contacts start to separate and a voltage in excess of this value is present, the arc will be maintained until the contacts are separated far enough to break the arc, or until the current and/or the voltage is reduced to such a value as to no longer sustain the arc.

As a vaporization of the contact material (usually tungsten) takes place because of the arc heat, the ionization voltage is reduced somewhat in the gap. Since in any vibrator operation there are generated peak voltages higher than those of the battery, it can be seen that there is a general tendency for this arcing condition to arise in 12-volt, or higher, power supply units. To distinguish between the normal sparking between the contacts and the ionization arc, which has been described, the latter is usually referred to as contact "flare." Under normal running conditions this flare would probably never be observed, regardless of the extremes of transformer and circuit design. The difficulty arises during the starting period, and reference to the earlier discussion of the mechanical phenomenon of vibrator-starting and the accompanying electro-magnetic transformer characteristics will be found valuable in the understanding of this discussion.

Because of this starting difficulty, which is a natural combination of the vibrator

and transformer, the power supply draws exceedingly high battery current during the transient period immediately following the closing of the starting switch. The extent to which this current exceeds the normal running current will determine to a large extent whether or not an arc will occur at this time. If the arc is of very short duration and is quickly quenched, little damage is done to the vibrator mechanism. However, if the arc persists for an appreciable portion of a second, the vibrator can be damaged, or even ruined, before a fuse will blow.

All vibrators must be started without this damaging effect occurring before their usefulness can be realized. The major problem in designing power supplies for the higher voltage inputs is to introduce limiting conditions which will prevent the occurrence of this starting arc. These limiting conditions may be supplied in the form of circuit components introduced for this specific purpose, or in the form of special design factors in the transformer itself.

The circuit devices that can be used with varying degrees of success can be outlined as follows. A series current-limiting resistor may be placed in the battery input lead. This should be large enough to drop the applied voltage (when the heavy current is flowing) to a safe value, but not large enough in value to seriously affect the overall efficiency or performance under the normal load conditions. A small iron-cored choke might be substituted for the resistor and be effective in limiting the surges, but this would seriously affect the normal vibrator performance in direct proportion to its reactive characteristics.

Other possibilities include the use of comparatively large values of interrupter "point" capacitors, connected between the reed and the respective contacts. While these capacitors are fairly effective in suppressing the arc, they also are detrimental to good contact life under the running condition. Therefore, only the minimum capacity required to suppress the arc should be used. A variation of this method which has proven effective, at least as an aid in suppressing the arc, is the use of at least a portion of the timing capacitance as a

primary "buffer" capacitor connected in parallel to the entire primary winding. In general, the minimum value of this capacity has been found to be about 0.50 mfd. for the input voltages being discussed. To be effective as an aid for arc suppression, no series resistor should be used with the capacitor.

As the result of military necessity, another approach to the problem was developed and patented by the P. R. Mallory Co., which permitted the use of small, light-weight transformers designed much in the same way as the normal 6-volt unit. This method consists of momentarily inserting in the primary circuit at the instant of starting a resistance of sufficient value to limit the maximum possible in-rush current to a safe value, and then removing this resistor during the running period. This provides for safe starting without arcing, yet does not penalize the power unit by keeping the limiting resistance in the circuit.

Two methods of accomplishing this are worth mentioning as a guide for possible adoption. One is a manually-operated switch for starting the power unit, of three or more consecutive positions. From the "off" position, the first step would be to a position where the entire resistance is placed in series in the circuit. The next position would short out part, or all, of this resistance, and so on. The other method employs an automatic relay of small size which is used as a shorting switch across the same value of additive resistance as in the first method. The coil ampere-turns are so chosen that for normal load operation conditions, the armature is inoperative and the relay contacts short-out the resistor. The coil is a series type, being placed in the center-tap lead in the primary circuit, where its inductive reactance can be also used as a "hash-elimination" filter choke. During the starting transient period, if a predetermined value of peak current flows in the circuit the armature operates, the shorting contacts are opened and the resistor is inserted in the circuit. The mechanical inertia of the armature combined with proper spacings permits the contacts to remain open until the

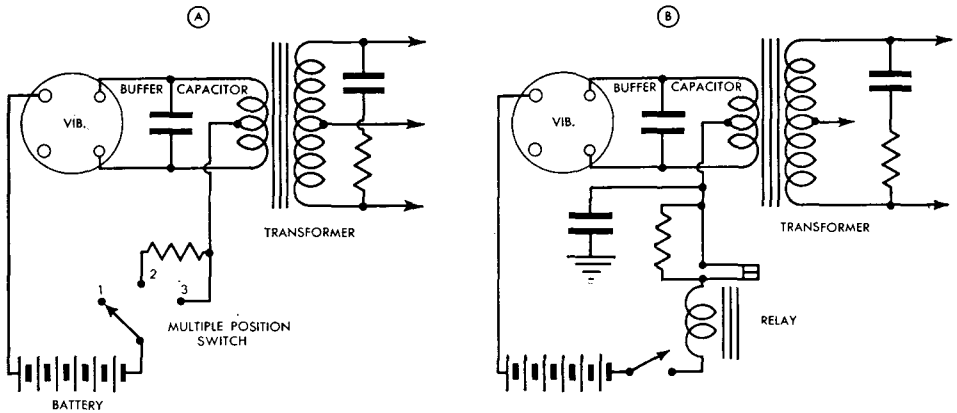

FIGURE 40

transient has passed and the steady-state has been reached.

Figure 40 illustrates the above preferred methods of control by circuit components. (A) shows the manual starting arrangement, with position 1 being off, position 2 being start and position 3 being the running position. It has been found that, with an index of the usual type on the switch, the movement from "off" to "on" cannot be made too fast to prevent the desired control to occur. (B) shows the automatic starting control as performed by the series relay.

With regard to the control of the starting transient difficulty through transformer design technique alone, some empirical standards have been established. The first relates to the maximum flux-density permissible, since the major part of the original difficulty arises from an unbalanced and excessive magnetic condition in the core.

A fairly low value of maximum flux-density must be established in order to hold down the peak magnetizing current to a value that can be commutated satisfactorily, and also in order to guard against the worst conceivable combination of circumstances of residual-flux and its polarity with respect to the following flux polarity at the next start and of poorly-starting worn vibrators. If this value is set between 40,000 and 45,000 lines per square inch for the highest expected starting volt-

age, experience has shown that satisfactory performance of the vibrator will result. In general, however, it is advisable to add the "primary buffer" capacitor to the circuit in addition to the transformer changes. Because of the leakage-reactance of the transformer, perfect reflection of the usual secondary timing capacitor is not attained, and the presence of an appreciable value of capacitance directly in the primary circuit aids in securing rapid starting of the vibrator in addition to absorbing some of the peak magnetizing current at the instant of contact "break."

Assume that the maximum flux-density is 40,000 lines per square inch. Then the residual flux-density will be 0.8 of this value, or 32,000. Under the worst conditions, the starting flux-density would then be 32,000 plus twice 40,000 or 112,000 lines. While this is into the saturation region, the ratio of "H" or ampere-turns for the transient and the steady-state conditions is roughly 300 to 2 (for Dynamo Grade), or 150 times.

Another technique in the design which assists in preventing difficulties arising lies in the proportioning of the core cross-sectional area and the primary turns in securing the required flux-density. It has been found that the use of a comparatively small cross-section of steel and a large number of turns on the primary accomplishes the desired results. The wire is somewhat small to secure this combination,

and, with the additional turns, provides a reasonably high primary circuit resistance which provides some measure of self-regulation. The larger number of turns also cuts the value of magnetizing current required for any flux-density encountered, which is desirable. A further advantage lies in the increased primary circuit inductance present to oppose the rapid rise of surge currents during the transient interval. Certain instances have indicated that the placement of the primary over the secondary winding assists in all of the above methods, and becomes an added advantage.

The use of a small effective air-gap in the core structure would tend to prevent saturation effects from being such a significant portion of the transient condition. However, to use a gap large enough to provide good control would entail a large steady-state magnetizing current which would not only be inefficient, but would also require a very large value of timing capacitance. Interleaving of the laminations in groups of 5X5, or 5X1, would seem to be about the maximum effective air-gap that would be practical for this purpose.

The use of the starting resistor in connection with the switch or relay has permitted flux-densities of 60,000 to 65,000 lines, with a corresponding decrease in overall size and weight. The use of some primary "buffer" capacity is still required, however. The value of resistance needed depends somewhat upon the load current being handled during the starting time, i.e., if a loaded or no-load condition prevails at the start; also upon the resistance of the primary circuit, including the transformer primary; and upon the maximum input voltage to be encountered.

For example, one 24-volt power supply required a 5-ohm, 5-watt, wire-wound resistor. Assuming that a maximum of 5 amperes could be carried and broken by the vibrator without a damaging arc, the voltage drop across the resistor with that current would have been 25 volts. With 3 amperes, the drop would have been 15 volts, or approximately one-half of the maximum expected voltage of 30 volts.

Since the magnetizing current required to generate a c.e.m.f. of approximately 15 volts would be much less than for the original 30 volts, the resistor accomplished the purpose intended. For a typical 12-volt unit the resistor had a value of 2 ohms, while another required only 0.75 ohms.

From the foregoing discussion, some of the difficulties to be encountered in the satisfactory design for the higher-voltage inputs will become apparent. The choice of method, or methods, to be used in the attainment of this result depends upon the circumstances of the requirements; the relative costs, and various other factors. The use of the relay is preferred. The switch, in combination with a suitable resistor, and a reasonably liberal transformer design is a second choice. The seriousness of this problem for those engaged in the manufacture of equipment for operation on these voltage inputs cannot be over-emphasized. However, the proper recognition of the difficulty and steps taken to correct it permits good performance and satisfactory life to be attained.

## **V. High-Frequency Vibrator Power Units**

All of the previous discussion has been with regard to "Standard Frequency" vibrators, whose nominal frequencies are 115 cycles per second. Since there is a trend toward the use of higher frequencies in vibrators for certain applications where this characteristic offers some advantages over the present frequency, it is desirable to discuss the transformer design in relation to special techniques required to secure good performance characteristics.

A discussion of the reasons for a high-frequency vibrator is timely at this point. The life of "low-frequency" vibrators, under the load conditions existing at the present, is considered very satisfactory from most standpoints. Therefore, it is hardly the expectation of securing increased life that suggests the use of "high-frequency" vibrators. In fact, where a 115-cycle vibrator contact pair "makes and breaks" 414,000 times per hour, a 250-cycle vibrator contact pair "makes and

breaks" 900,000 times per hour. If the same contact "burden," or wearing characteristics, exist in the circuit, the high-frequency unit will thus wear out that much faster than the low-frequency unit. This presupposes that advancements in the design of the units and in the contact materials have not taken place.

Higher frequencies immediately suggest that the size of the transformer can be reduced and that in this manner a smaller over-all power unit size and cost can be secured. This is indeed the prime object in increasing the operating frequency.

By reducing the over-all size of the transformer, the weight of the core is reduced and thus the core-losses per assembly may be held down although the watts loss per pound increases. The copper-losses may also be reduced because of the fewer turns required and the smaller mean length-of-turn resulting from the smaller core used. However, from an overall viewpoint, it appears that the copper-losses might better be allowed to remain high, with the emphasis placed upon reduction in core losses. This latter can be accomplished by the use of a better grade of lamination steel, and by the reduction in the thickness of the lamination. The former reduces both the hysteresis loss and the eddy-current loss, while the latter reduces the eddy-current loss alone.

One difficulty in the use of thin laminations in an interleaved core is that the core-stacking factor generally decreases as the thickness of the steel decreases. This is caused by burrs and insulating surfaces upon the laminations, the effects being multiplied as the number of laminations required to produce a given core stack increases, and by irregularities and lack of flatness in the laminations. Tests have indicated that #29 gauge (.014" thick) laminations are the thinnest practical gauge to use for economical vibrator power transformers of standard construction. Greater compactness in transformer design can be achieved by using thinner steel in cores of the "Hypersil" type, which also have the additional advantage of greater permeability, permitting higher flux-densities.

The fact that the dimensional allow-

ances for insulation, both as inter-layer insulation and as wrappers, and the core-tube thickness remain fairly fixed for a given loading (since the wire sizes remain reasonably fixed), and because a fixed reasonable clearance must be allowed in the coil build, the reduction in lamination size is not necessarily proportional to the increase in frequency. This is because the percentage of the window space available for copper is reduced with the smaller sizes where the window area is smaller.

The choice of actual values of flux-density, wire current-density, the ratio of cross-sectional area to primary turns, etc., all depend to a large extent upon the individual requirements for efficiency and heating, vibrator performance and life, size and cost, etc. As a general rule, the flux-density for the maximum operating input-voltage should be somewhat lower than in the case of the low-frequency vibrator even when #29 gauge Transformer "A" grade, or its equivalent, is substituted for the #24 gauge Dynamo grade commonly used at the lower frequency. Where 55,000 and 65,000 lines per square inch maximum values were recommended for conservative and liberal designs, respectively, for low-frequency units, 50,000 and 60,000 values should be suggested as maximums, respectively, in the case of the high-frequency units. These lower flux-densities also provide for better wave-form operation over the input-voltage range, which is highly desirable if good life is to be secured.

The following Sample Design No. 4 illustrates some of the problems involved in reaching the most desirable conclusion of a design for high-frequency transformers, as contrasted with the approach to 115 cycle units. The requirements have been chosen to be the same as those for Sample Design No. 1, except that a self-rectifying vibrator is to be used. This eliminates the tube plate resistance voltage drop. The approach to the design consists of first changing the design of No. 1 to the conditions of No. 4, and then creating another design on a smaller lamination size in order to determine by comparison which of the two designs offers the most desirable characteristics. Size and cost may be consid-



ered as an important factor, but so must efficiency and heating be considered. Regulation (represented by low coil resistances) is a factor depending upon the service requirements.

These designs for the high-frequency types represent a guide for the designer rather than suggested designs themselves. This same viewpoint should be exercised toward the other designs included in this chapter. They are all included to illustrate the principals that were discussed in the text regarding the principal groups of designs.

## No. 4—Sample Design— Vibrator Transformer

(Same as for No. 1, except high frequency)

**Requirements:** (See Chapter I):

- To power a low-priced, single-unit auto radio receiver for domestic broadcast service with a "high-frequency" vibrator; frequency range, 550 to 1600 kc.; intermediate amplifier frequency (IF) of 455 kc.
- Cost and size reduction are the most important considerations in the design.
- Output = 240 volts at 50 Ma., measured at the first filter capacitor (DC meters).
- Input = 6.3 volts at the transformer primary center-tap (DC meter). Voltage variation = 5.5 to 8.0 volts at the CT.
- No rectifier tube required—self-rectifying vibrator used.
- Vibrator: 250-cycle self-rectifying type.
- Smoothing filter: 10-10 mfd., 350-volt capacitor, with 500 ohms resistance connected between sections. The output power tube receives its plate voltage from the first filter capacitor connection. The rest of the receiver tubes are to be connected to the output of the filter.
- "B—" voltage may be a ground potential, so that the self-rectifying vibrator may be used satisfactorily.
- The tubes are all of the indirectly-heated type. This involves a no-load condition at the start.
- Operation is considered continuous, with a fairly high ambient temperature.
- All of the power supply components will be mounted upon the receiver chassis. Ventilation will not be too good, but some will be provided.

### Calculations: (Preliminary):

Output Watts:  $240 \times .050 = 12.0$  watts (DC meter values); @ 6.3 volts CT.

Estimated Efficiency: 73% (for medium loading and high frequency.)

Input Watts:

$$\frac{12.0}{.73} = 16.4 \text{ watts @ 6.3 volts CT.}$$

Input Current:

$$\frac{16.4}{6.3} = 2.6 \text{ amperes (DC meter value)}$$

Approximate Maximum Flux-Density:

$$B_m = 60,000 \text{ lines per square inch @ 8.0 volts CT.}$$

**Vibrator Characteristics:** (For this sample design, the following values are assumed as being representative)

Frequency: 250 cycles (average)

Time efficiency (interrupter) = 0.85 (average)

Time efficiency (rectifier) = 0.75 (average)

Rated input voltage = 6.3 volts CT.

Rated input current = 4.0 amperes (max.)

Output voltage at 6.3 volts CT. and full load = 300 volts DC (max.)

From the above calculations and characteristics, it is noted that the estimated input current at 6.3 volts is only 65% of the maximum allowable for good life expectancy and that the output voltage will be the maximum allowable. Therefore, this type of vibrator will be satisfactory for the design.

**Calculations:** (Wire size determination):

Using Equation (18):

$$\text{RMS } I_2 = \frac{\sqrt{.75}}{.75} \times .050 = 1.154 \times .05 = .058 \text{ amperes}$$

$$\text{RMS } I_1 = \frac{\sqrt{.85}}{.85} \times 2.6 = 1.086 \times 2.6 = 2.82 \text{ amperes}$$

$$\text{Heating Value of } I_2 = .707 \times .058 = .041 \text{ amperes}$$

$$\text{Heating value of } I_1 = .707 \times 2.82 = 1.99 \text{ amperes}$$

Assume a tentative value of 650 CM/amp. current density;

Secondary:  $650 \times .041 = 26.7$  CM required

Primary:  $650 \times 1.99 = 1294$  CM required

From the table in Figure 26, Chapter VII:

Secondary:

$$\#36 (= 25 \text{ CM}) = \frac{25}{26.7} \times 650 = 609 \text{ CM/ampere}$$

$$\#35 (= 31.4 \text{ CM}) = \frac{31.4}{26.7} \times 650 = 764 \text{ CM/ampere}$$

Primary:

$$\#19 (= 1290 \text{ CM}) = \frac{1290}{1294} \times 650 = 648 \text{ CM/ampere}$$

$$\#18 (= 1024 \text{ CM}) = \frac{1620}{1294} \times 650 = 814 \text{ CM/ampere}$$

In order to use the minimum of steel in the core, #19 wire should be used on the primary and #36 wire on the secondary.

**Calculations:** (Primary turns and core determination):

Equation (15), Chapter VIII:

$$N_1 \times A = \frac{E_1 \times \omega t \times 10^8}{4 \times B \times K_c \times f}$$

$$N_1 \times A = \frac{8.0 \times .85 \times 10^8}{4 \times .60 \times 10^5 \times .92 \times 2.5 \times 10^2} = \frac{6.80 \times 10^8}{5.52 \times 10^7} = 12.32$$

I. If the conversion to 250 cycles is made by using the same windings as were used on Design No. 1, and the core stack reduced, using the same EI-11 size of laminations, the results would be: (72 T. #19 and 4070 T. #36);

$$A = \frac{12.32}{36} = 0.342 \text{ sq. in.}$$

$$\text{Stack} = \frac{0.342}{.875} = 0.391''$$

$$\frac{3}{8}'' \text{ stack} = .375''$$

The weight of iron is cut from 1.01 lbs. (115 c/s.) to .435 lbs.;

Original  $a = 56.6$ ;

Original output voltage = 264 volts, (including tube drop);

$$\text{Revised } a = \frac{240}{264} \times 56.6 = 51.4$$

Allowing for reduced MLT, assume  $a = 50.0$

$$N_s = 72 \times 50 = 3600 \text{ turns of } \#36$$

$$\text{Layers} = \frac{3600}{170} = 21.2 \text{ layers}$$

Use  $\frac{3}{8}''$  stack and 72 turns on primary:

$$B_m = \frac{8.0 \times .85 \times 10^8}{4 \times 328 \times .91 \times 250 \times 36} = 63,300 \text{ lines/sq.in.}$$

**Calculations:** (Secondary and voltage determination):

$$\text{MLT}_p = (2 \times .375 + 2 \times .875 + 8 \times .05) + 4 \times .129 = (.874 + 1.75 + .40) + .516 = 2.90 + .516 = 3.42''$$

$$\text{MLT}_s = (2.90 + 8 \times .129 + 8 \times .01 + 2 \times .10) + 4 \times (22 \times .0068) = 4.21 + .598 = 4.81''$$

$$R_{t1} = \frac{72 \times 3.42 \times 8.05}{2 \times 12 \times 1000} = 0.083 \text{ ohms per half}$$

$$R_{t2} = \frac{3600 \times 4.81 \times 414.8}{2 \times 12 \times 1000} = 299 \text{ ohms per half}$$

$$E_2 = [6.3 \times 50 - (.083 \times 2.82 \times 50 + 299 \times .058)] \times .85$$

$$E_2 = [315 - (11.7 + 17.3)] \times .85 = (315 - 29) \times .85 = 286 \times .85 = 243 \text{ volts}$$

240 volts required

$a = 50$  is satisfactory

NOTE: While this appears to result in a satisfactory design, it is standard practice to try to make the core nearly square in size for ease in winding coils. This design requires only a  $\frac{3}{8}$ " stack of EI-11 which has a  $\frac{7}{8}$ " center-leg. Therefore, the EI-75 lamination would provide a more suitable core arrangement.

## II. Using EI-75 size lamination:

$$N_1 \times A = 12.45;$$

$$3 \text{ layers \#19 E.} = 3 \times (.0382 + .005) = 3 \times .043 = .129"$$

$$3 \text{ layers} = 3 \times 21 = 63 \text{ turns max.};$$

$$\text{Use } N_p = 60; N_1 = 30;$$

$$A = \frac{12.45}{30} = 0.415 \text{ sq. inches};$$

$$\text{Stack} = \frac{0.415}{0.75} = 0.553"$$

With a  $\frac{9}{16}$ " stack:

$$A = .75 \times .562 = .422 \text{ sq. inches};$$

$$B_m = \frac{8 \times .85 \times 10^8}{4 \times .442 \times .92 \times 250 \times 30} =$$

$$58,400 \text{ lines/sq.in. @ 8.0 volts}$$

**Calculations:** (Secondary determination, and check upon coil build):

Coil build allowable = 0.260" (max.) for paper and wire alone;

Allowable for secondary =  
.260 - .129 = .131"

$$\text{Layers of \#36 E. wire} = \frac{.131}{.0067} =$$

$$19.6 \text{ layers; } 20 \text{ layers} = .134" \text{ (.003" excess);}$$

$$N_s = 20 \times 145 = 2900 \text{ turns (max.) in } 20 \text{ layers}$$

$$a = \frac{2900}{60} = 48.3 \text{ (too low)}$$

Approximate turn-ratio required (from previous design) = 50

$$N_p = \frac{2900}{50} = 58 \text{ turns}$$

$$B_m = 58,400 \times \frac{30}{29} = 60,400 \text{ lines/sq.in. at } 8.0 \text{ volts}$$

$$N_s = 50 \times 58 = 2900 \text{ turns}$$

$$\text{Layers} = \frac{2900}{145} = 20 \text{ layers or } 20 \times .0067 = .134" \text{ build}$$

$$\text{Coil build: } (.050 + .129 + .134 + .015) = 0.328"$$

$$\frac{.330}{.375} = 87.5 \%$$

$$MLT_p = (2 \times .562) + (2 \times .75) + 8 \times .05 + (4 \times .129) = 3.024 + .516 = 3.54"$$

$$MLT_s = 3.024 + (8 \times .129) + (8 \times .01) + (2 \times .10) + (4 \times .134) = 4.87"$$

$$R_{t1} = \frac{58 \times 3.54 \times 8.05}{2 \times 12 \times 1000} = 0.069 \text{ ohms per half}$$

$$R_{t2} = \frac{2900 \times 4.87 \times 414.8}{2 \times 12 \times 1000} = 244 \text{ ohms per half}$$

$$E_s = [6.3 \times 50 - (.069 \times 2.82 \times 50 + 244 \times .058)] .85$$

$$= [315 - (.97 + 14.2)] .85 = (315 - 23.9) .85 = 291.1 \times 85 = 247 \text{ volts}$$

240 volts required

$$a = \frac{240}{247} \times 50 = 48.6$$

$$N_s = 2900 \times \frac{48.6}{50} = 2820 \text{ turns}$$

## Specifications:

Core:  $\frac{9}{16}$ " stack of #EI-75 laminations; #29 gauge, transformer "A" grade, or equivalent; laminations to be inter-leaved in groups of  $2 \times 2$ , or less.

Core Tube: .050" thick, built up from gummed Kraft paper, or equivalent.

Primary: 58 turns of #19 enamel wire, tapped at 29 turns; tolerance on number of turns and tap location = + or - 0%; 3 layers, with .005" Kraft paper between layers.

Primary Wrapper: 1 layer of .005" gummed Kraft paper, in addition to the one layer included in the third primary layer calculated above. Total = .010".

Secondary: (Wound over primary): 2820 turns of #36 E. wire, tapped at 1410 turns; tolerance on number of turns = + or - 1%; Tap must be at center. 20 layers, with .001" glassine paper between layers.

Outer Wrapper: 2 layers of .005" gummed Kraft paper, or equivalent.

Leads or Terminals: As required by the application or mounting

#### Notes:

1. This method of calculation is rather conservative, and probably will result in a turn-ratio which will develop an output voltage that is higher than desired. This is desirable in order that any changes necessary after a sample has been built and tested will not involve the use of a greater window area. Thus, lamination dimensions will not require changing. Should a correction in output voltage be necessary, it is accomplished by the simple expedient of reducing the number of secondary turns by the ratio of the desired voltage to the measured voltage.
2. The sample transformer should be tested with a representative number of typical vibrators in order to secure an average output condition. This is necessary in order to determine the correct timing capacitance, as will be discussed in a later chapter. Both tests may be carried out simultaneously.
3. The use of a high-vacuum rectifier tube in place of the Type 0Z4A would probably result in less output voltage being required, because of the lower average tube plate drop (as given in published ratings) for the current being handled. However, based upon experience, the rating of 24 volts given for the 0Z4A in published ratings seems to be too high. Many comparative tests have shown that the output with a tube such as the Type 6X5 is practically identical with that when using the 0Z4A in the normal range of currents. If this situation is encountered, the above calculated turn-ratio may be adjusted accordingly.
4. Other differences in the final output voltage achieved may result from the several variations in the vibrators themselves from the rated averages. These may appear as variations in time efficiency, frequency, and contact resistance.

#### Supplementary Calculations:

I

@ 6.3 Volts C.T. @ 8.0 Volts C.T.

**Magnetizing Currents:** (Using #29 ga. Transformer "A" Grade Steel):

$B_m = 47,600$	60,400
$H = 2.1$	3.5
$l_m = 4.50"$	4.50"
$N_1 = 29$	29
$i_m = 326 \text{ A}$	.543 A.

**Approximate Core Losses:** (Watts per pound =  $6.25 \times 10^4 e + 250 h$ , for #29 ga. material):

$e = 18.6 \times 10^{-6}$	$28.2 \times 10^{-6}$
$h = 4.3 \times 10^{-3}$	$7.30 \times 10^{-3}$
W./Lb. = 1.16 + 1.23	1.76 + 1.83
= 2.39	3.59

EI-75 = .857 lbs. per inch stack

Wt. of core = .857  $\times$  .562 = .482

Losses = 1.15 W      1.73 W.

#### Approximate Copper Losses:

Watts =  $(I_1^2 R_{t1} + I_2^2 R_{t2})$

Where I = RMS values;

$R_{t1} = .069$       .069

$R_{t2} = 244$       244

$I_1 = 2.82$       3.58

$I_2 = .058$       .074

Watts = .54 + .82      .87 + 1.33

= 1.36 W.      2.20 W.

#### Total Copper and Core Losses:

= 2.51 W.      3.93 W.

It would be interesting to determine what the differences would have been if #24 gauge, Dynamo grade, or equivalent, steel had been used in the core instead of the #29 gauge, Transformer "A" grade that was used. The following calculation will show this comparison:

I.

@ 6.3 Volts C.T. @ 8.0 Volts C.T.

**Magnetizing Currents:**

$B_m = 47,600$	60,400
$H = 2.3$	3.35
$l_m = 4.50''$	4.50''
$N_1 = 29$	29
$i_m = .357 \text{ A.}$	.52 A.

**Approximate Core Losses:** Watts per pound =  $20.0 \times 10^4 \times e + 250 h$ ; for #24 ga. and 250 c/s.

$e = 21.8 \times 10^{-6}$	$32.6 \times 10^{-6}$
$h = 8.6 \times 10^{-3}$	$13 \times 10^{-3}$
$W./\text{Lb.} = 4.36 + 2.15$	$6.52 + 3.25$
$= 6.51 \text{ W.}$	$9.97 \text{ W.}$
<b>Losses = 3.14 W.</b>	<b>4.71 W.</b>

**Total Copper and Core Losses:**

$= 4.5 \text{ W.}$	$6.91 \text{ W.}$
--------------------	-------------------

## Timing Capacitor Considerations

■ The timing capacitor, or "buffer" capacitor, is the third important element to be considered in designing a vibrator power supply. The proper value of the timing capacity must be established if satisfactory vibrator performance and life is to be obtained. *In fact, the vibrator, the transformer, and the timing capacitor are so interdependent on each other that one cannot be considered without the other two.* The purpose of this chapter is to explain the use of the timing capacitor, its proper location in the circuit and the method of determining its proper value. The wave-form is interrelated to the timing capacity and will also be discussed in this chapter.

An ideal condition, where the time efficiency is unity and no interval exists during the switching period of the vibrator, is shown in Figure 41, a reproduction of Figure 5. The contacts break at point (2) at the same instant that the opposite pair of contacts make at point (3), etc. This ideal arrangement, of course, cannot exist and is given for illustration only.

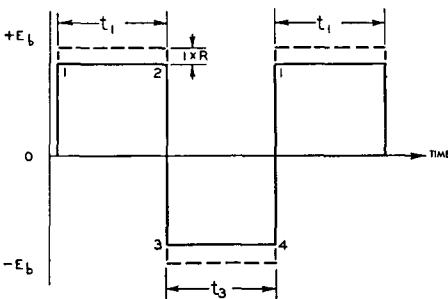

FIGURE 41

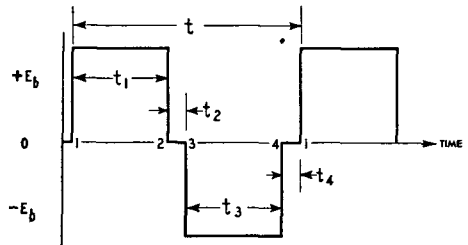

FIGURE 42

Figure 42, a reproduction of Figure 6, illustrates the respective time intervals involved in a representative commercial vibrator design. In this practical arrangement, a discontinuity in applied voltage occurs between each half-cycle. Symbols " $t_1$ " and " $t_3$ " represent the "on-contact" time intervals, while " $t_2$ " and " $t_4$ " represent the "off-contact" or "switching" time intervals. The upper, or first, pulse shown represents the "pull" side contacting interval, while the lower pulse represents the "inertia" contacting interval. The "pull" contacts make at (1) and break at (2), and the "inertia" contacts make at (3) and break at (4), after which the cycle is repeated. The time interval " $t$ " is the length of time required for one complete cycle of operation.

The wave-form shown in Figure 42 can be reproduced experimentally by operating the vibrator into a center-tapped resistor having a comparatively low resistance value, and with provision made for obtaining the correct driving coil voltage. This arrangement offers a satisfactory laboratory expedient in testing vibrators, and will be discussed later. However, it should

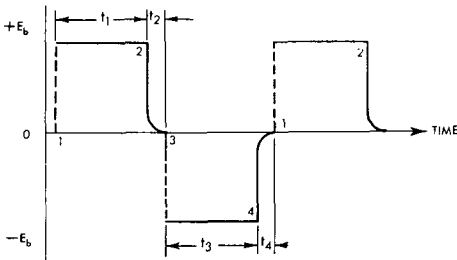

FIGURE 43

be noted that the required input voltage for securing proper reed amplitude of the vibrator is dependent upon the type of driving system employed. For a vibrator unit using a "separate-driver" system the nominal battery voltage of the unit is employed. In a "shunt-coil" driver system it is necessary to double the nominal battery voltage of the unit, since with this system the auto-transformer action, that is normally present in the transformer primary, will not be available. When the center-tapped primary of the transformer is connected to the vibrator and battery, an unstable inductive component is introduced into the circuit. Magnetic flux is built up in the transformer core while the contacts are closed during " $t_1$ ." Since the polarity of the magnetic-flux during the next half-cycle, " $t_3$ ," is the reverse of that during " $t_1$ ," the energy previously stored during " $t_1$ " must be dissipated during the interval " $t_2$ ," or a sudden reversal would take place when the inertia contacts close at (3). If no control is placed in the circuit, an excessively high induced voltage would occur at the break of the contacts at (2) when the collapse of the magnetic-flux occurs. A second, but lower, transient voltage would occur at the make of the contacts at (3). The above considerations are all based on a transformer under a "no load" condition.

Figure 43 illustrates the change in the wave-form that can be obtained by properly proportioning a resistive load to the prevailing transformer characteristics. The wave-form varies during the " $t_2$ " and " $t_4$ " intervals according to the value of the load resistance. Such an effect occurs when a heavy "filament" or "heater" tube load is

added to a vibrator power transformer. For the values of load normally occurring as "plate" or "B-circuit" loads and similar applications, the effect upon the circuit is not sufficient to prevent the occurrence of disastrous transients. When the self-rectifying vibrator is used, the load is disconnected before the interrupter contacts open and no control is present. When the interrupter vibrator and a rectifying tube is used, the threshold voltage action of the rectifier will produce similar results.

The suppression of these transient voltage conditions requires the use of "buffer" capacitors across the vibrator contacts and will provide reasonable control, thus preventing voltage breakdowns in the transformer insulation or external elements. In the early development stages the capacity of these capacitors was arbitrarily chosen, mainly by guess work and experimentation and without regard to the theory involved. Their use in this manner resulted in rapid material transfer of the vibrator contacts which eventually caused the contacts to "lock" together and shorted the vibrator, or destroyed the contacts.

Further investigation and development resulted in the use of a single capacitor connected across the full winding, which provided the same control of the transient conditions without the disastrous contacting action. Figure 44, a reproduction of Figure 8, illustrates the results obtained with the use of a timing capacitor in securing the desired control. For purpose of illustration, assume that the capacitor has been connected across the primary winding, and has a capacitance of  $C_1$  mfd., and that the inductance of the primary winding under the influence of the DC magnetization existing at point (2) in the

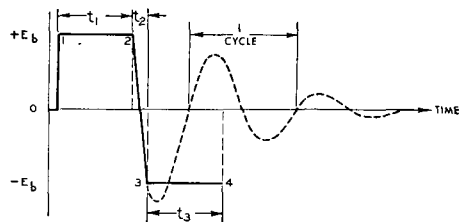

FIGURE 44

cycle is  $L_1$  henries. Upon the break of the contacts at point (2), a shock excitation of the LC circuit occurs, resulting in the start of a highly damped oscillation. If the succeeding half-cycle did not take place, the oscillographic trace of such an oscillation would appear similar to that shown in the dashed wave. The frequency of oscillation depends upon the equation:

$$f = \frac{1}{2\pi\sqrt{LC}}, \text{ and time of 1 cycle equals}$$

$$t_o = \frac{1}{f}$$

The inductance of a transformer of a given design, and the vibrator characteristics are fairly constant. Therefore, in order to change the frequency of oscillation, a change in the capacitance must be made. By properly choosing the value of this capacitance, the slope of the portion of wave forming the first  $\frac{1}{4}$  cycle of the oscillation can be so adjusted that the wave will exactly close the gap between points (2) and (3) as shown in the illustration. Thus, when the inertia contact pair closes at point (3), the transformer primary voltage has been reversed during interval "t<sub>2</sub>" and the contacts close with zero voltage difference between them. The transient at the break has been eliminated and the cause of the transient at the make has been removed. Correspondingly, the same condition occurs when the inertia contacts open at (4). The process is a continuous repetition of the above cycle.

The determination of the value of capacitance that will satisfy the above conditions by the described method, requires an experimental arrangement with the specified transformer and vibrator combination and a variable timing capacitor. It also requires a suitable cathode-ray oscilloscope for observing the wave-form. The oscilloscope should be connected across the entire primary winding, so that any suppression of transient phenomena will be avoided. The connection to the primary, rather than to the secondary, involves working with lower voltages and eliminates a large portion of the effects of the leakage reactance of the transformer.

Occasionally it has been advocated that this capacitance value can be determined by meter readings only, but experience has demonstrated that that method is faulty and inaccurate and should only be used when equipment for wave-form observation is not available.

This method provides an ammeter in the battery lead, the operation of the power supply on no-load, and a variable timing capacitor. The indication of the meter is observed as the value of capacitance is changed, and the point at which a minimum reading on the meter is observed is noted. One disadvantage with this method is the low sensitivity of the indicating ammeter. The change in current is very slight over a rather wide percentage change in capacitance at the minimum point. This is the equivalent of a poor selectivity-curve in a radio receiver or the nose of a probability curve, and the difficulty of deciding the exact center of the curve is easily understood. A partial solution is the determination of equal points on either side and using an average value between them. Also, it is impossible to determine if the vibrator is "balanced," a condition which also affects the capacitance value. The "balance" will be discussed at a later point, and this connection will be further explained.

It is often very desirable to be able to predict the approximate value of the timing capacitor that is to be used with a given transformer design. Provided that the B-H curves used in making the necessary transformer calculations are reasonably representative of the lamination steel and that the Vibrator characteristics are near the average values given on the Data Sheets, this prediction can be made satisfactorily. At least the approximation will serve as a guide to the later accurate experimental determination.

Referring again to Figure 42, the time interval "t," for a vibrator of frequency "f," can be shown as

$$t = \frac{1}{f}; t_1 = \frac{1}{2f} \times \omega_t; \text{ and } t_2 = \frac{1}{2f} \times (1 - \omega_t);$$

where the time efficiency,  $\omega_t$ , is expressed as a decimal value. The above determines



the time interval " $t_2$ ," during which the voltage-reversal must take place, in terms of the known characteristics of the vibrator, i.e., the frequency and the time efficiency. In the case under consideration, the voltage must change from a maximum (equal to the battery voltage) of one polarity to a maximum of the opposite polarity in the time interval " $t_2$ ." Therefore, the required timing capacitance for a given set of circuit conditions will be:

$$(28) \quad C_1 = \frac{(1 - \omega t) \times i_m \times 10^6}{2 \times f \times 4 \times E_1} = \frac{(1 - \omega t) i_m \times 10^6}{8 f E_1} \text{ mfd.}$$

It can be assumed that, at no-load,  $E_1$  equals the battery voltage  $E_b$ . Equation (28) shows that the peak value of the magnetizing current must be determined for any given input voltage, in order to calculate the approximate value of timing capacitance required for that voltage. This follows the determination of the flux-density for the voltage concerned, using the B-H curve for the grade of steel involved, and the calculation of the current using one-half of the number of primary turns and the length of magnetic-flux path.

$$(29) \quad i_m = \frac{H \times l_m}{N_1} \text{ amperes (peak)}$$

The use of the foregoing formula will sometimes result in an approximate value of timing capacitance which is different than the optimum value as found by the use of a standard transformer, standard vibrator and oscilloscope. Therefore, this calculated value may have to be modified by a factor which will vary with transformer design. This factor can be pre-determined only by experience. Consequently, the calculated value from the formula must be used only as an approximation and not as the final optimum value.

The foregoing discussion has been relative to the selection of the proper value of timing capacitance to secure complete reversal of the input voltage during the switching intervals (" $t_2$ " or " $t_4$ ") of the vibrator. If this has been accomplished, the wave-form will appear as illustrated in

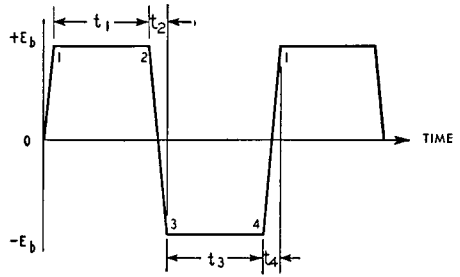

FIGURE 45

Figure 45. Note that the vertical portions of the wave completely close the gaps between points (2) and (3) and between points (4) and (1). This is known as 100% closure of the wave-form and is a theoretical, or ideal, condition that is not possible or even desirable in actual practice. The attainment of such a condition would require an exact "balance" between the pull and the inertia sides of the vibrator (i.e. the values of time intervals would have to be such that  $t_1 = t_3$  and  $t_2 = t_4$ ). Also, the magnetizing action of the two halves of the primary would have to be identical and an exact value of timing capacitance would be required. However, this wave-form is the basic standard of reference.

It is interesting to note the change in wave-form when various values of timing capacitance are used. Figure 46 illustrates the change that would appear if too small a value of capacitance is used. The frequency of oscillation increases, reducing the time " $t_0$ " for one complete cycle, and causes the peak of the first  $\frac{1}{4}$  cycle to pass before the contacts close. This is known as "over-closure." Figure 47 illustrates the use of an excessively large value of timing

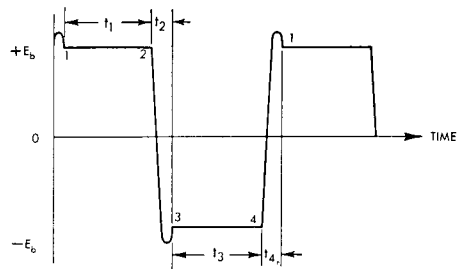

FIGURE 46

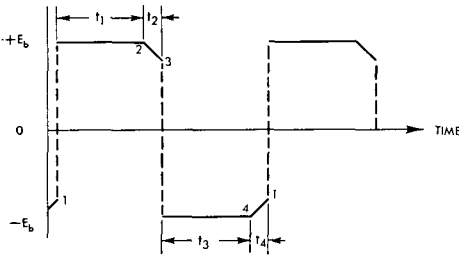

FIGURE 47

capacitance. The frequency of oscillation has been greatly reduced, increasing the time " $t_o$ " for one complete cycle. This causes the amount of voltage reversal that can occur in the time interval " $t_2$ " to be a very small percentage of the needed amount. This is known as "under-closure," or "short-closure."

Both of the above conditions are to be avoided if good performance of the vibrator is to be secured. Over-closure induces poor starting characteristics with the resultant abnormal currents and induced voltages. Also, since any contact erosion (wear) will increase " $t_2$ " and " $t_4$ ," the condition will rapidly get worse with age. Extreme under-closure induces transient voltage and current peaks at the make of the contacts, when the contact pressure is just beginning to build up, and causes rapid erosion, or "transfer" (metallic deposition of the material of one contact upon the other), of the contacts causing short vibrator life. If transfer of the contact material is severe and of the right character, "locking" of the contact pairs is inevitable, with failure resulting. In the past, some vibrator manufacturers have recommended excessive values of timing capacitance to counteract for the poor vibrator starting characteristics. However, increased experience and improved mechanisms have eliminated this problem. A wave-form condition having bad under-closure also will result in the generation of a greater amount of "hash" interference, as might be expected, because of the larger transients.

As a result of the above described effects of over-closure and under-closure, a rather general practice has been adopted,

which is a compromise with the ideal condition as illustrated in Figure 45. For the average vibrator characteristics, a wave-form standard is selected which has less than 100% closure, but which also has sufficient closure to off-set the effects of extreme under-closure. An example of such a wave-form standard is shown in Figure 48, where a closure of approximately 65% has been illustrated. This permits the voltage-reversal to cross the zero, or neutral, line and increase to a small amount in the opposite direction before the contacts close. It must be remembered, however, that this closure of 65% has been selected on the basis of average vibrator characteristics. In actual practice, considering the production tolerances in vibrators, transformers, and condensers, it is highly improbable that this exact condition will be observed on any combination of these three units taken from production lots. However, these small variations do not seriously affect the overall performance and an adjustment to obtain a 65% closure for each individual power supply is not required.

Examination of Equation (28) will quickly indicate that the value of timing capacitance for 100% closure will vary inversely as the input voltage, or vibrator frequency, and directly as the magnetizing current. If the vibrator frequency and time efficiency remained constant with changes in input voltage, then the magnetizing current would increase at the same proportional rate as does the input voltages, and the capacitance value required would remain constant for all input voltages. This would be true in practice were it not for the curvature of the B-H curve of the core steel, since the flux-density

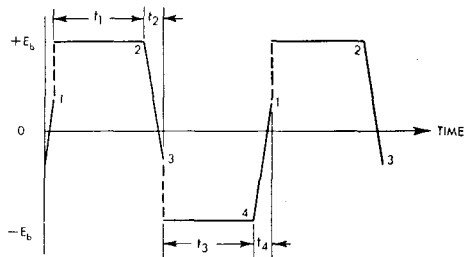

FIGURE 48

varies directly with the input voltage. However, at the flux-densities usually employed, the magnetizing current increases at a faster rate than does the input voltage. This infers that a greater value of timing capacitance will be required at the maximum input voltage than will be required at the rated input voltage, in order to maintain 100% closure in both cases. This has been proven in actual practice. An exception is the unusual instance of operation at comparatively low flux-densities.

*This would indicate that it is highly desirable for the transformer to be designed so the operating variations in flux-density will follow the straight line portion of the B-H curves as nearly as possible, thus limiting the timing capacitance shift to an acceptable minimum.*

Operation of auto-radio power units with a maximum flux-density around 65,000 lines per square inch usually results in a very acceptable shift in closure between 6 and 8 volts input. An increase to a maximum of 75,000 lines will result in a much greater shift in closure between input voltages of 6 and 8 volts and a consequent deterioration of vibrator performance. For example, with a 60% closure at 6 volts, approximately 100% closure would result at 8 volts.

The above presupposes that the time efficiency and the frequency do not change with changes in input voltage. Actually, an increase in voltage generally will cause a slight increase in time efficiency and frequency. The increase in frequency will slightly decrease the required capacitance through direct application to Equation (28). An increase in frequency will also slightly decrease the required capacitance by an indirect means, since it will reduce the flux-density and the resultant magnetizing current. While slight, these changes are in the desired direction. The slight increase in time efficiency will result in a much greater percentage reduction in the values of " $t_2$ " and " $t_4$ " off-contact times. Equation (28) shows that the value used is  $(1 - \omega_t)$  and not merely  $\omega_t$ . Consequently the timing capacitance is reduced proportionately. However, these reductions are

not sufficient to off-set the undesirable shift previously mentioned. Vibrators, transformers and timing capacitances for use in production must all be manufactured with certain minimum tolerances of performance in order to be made economically. As the tolerances are made wider the cost per unit is generally reduced, and where cost is a major factor, tolerances are set at the maximum allowable limits. However, with three components so interdependent upon each other for the proper performance of the complete unit, there must be rather close tolerances maintained if good average performance is to be secured. The effects of variations in the characteristics of the vibrators and transformers from the nominal averages affects the choice of the nominal value of timing capacitance. Since the capacitor is usually selected last among the three components, it is wise to secure an average condition to be used as a basis for such selection. This involves at least several representative sample transformers from all of the suppliers who are expected to furnish production units, and at least six vibrators from the principal source, or sources, of supply. These should be representative of production units such as will be supplied on the order. As was previously indicated, in the sample transformer design notes, the test for selection of the value for the timing capacitance may be co-ordinated with the test of the sample transformers and vibrators for correctness of the transformer design.

As a further check to determine if the selected combination of transformer and timing capacitance is completely satisfactory for the operation of the vibrator throughout its life, it is advantageous to use some partially worn-out vibrators along with the new vibrators in these tests. Good starting should result at all voltages and serious over-closure should not result at high battery voltages. These same worn vibrators are valuable as a check of the complete receiver for sufficient "hash" elimination filtering and shielding, since the older vibrator will probably create a greater amount of such undesirable "hash" interference.

Regardless of the final application of the power supply, the fact still remains that some wear of the vibrator will necessarily occur with age. The amount of wear will depend upon the design of the mechanism as well as upon the load being commutated and the service conditions, so the application must be considered when the choice of a capacitance value is being made. As wear occurs, the value of " $t_2$ " and " $t_4$ " intervals will increase; thus the value of original capacitance selected must be larger than is absolutely essential for the original conditions in order to provide a sufficient value for the worn condition. Mobile equipment, such as auto receivers, have a wider range of input voltages than do farm or portable receivers operating without a charger. Thus the spread of wave-form closure to be expected, or which must be tolerated, will be greater in the case of the former than it will be for the latter.

As a result of the foregoing discussion regarding timing capacitance value determination, it can readily be seen that a number of factors must be considered in making this determination. The P. R. Malloy Company has adopted a standard transformer for this purpose and uses a comparison method. This transformer has been so designed as to incorporate the maximum allowable capacitance shift between nominal and maximum input voltages, both load and no load. The buffer capacitance selected is optimum for this transformer and has been determined by years of experimenting and life testing with the transformer. In addition, duplicates of this standard transformer and timing capacitance are used for all factory-adjusting of vibrators. As a result, the use of this standard transformer and timing capacity provides a fast and accurate method of determining the timing capacitance values required for new transformer design. The correct timing capacitance value required for any newly-designed transformer can readily be determined by observing the vibrator characteristics of any production vibrator when operated with the standard transformer and its timing capacitor. Then the newly-designed transformer is substituted for the standard

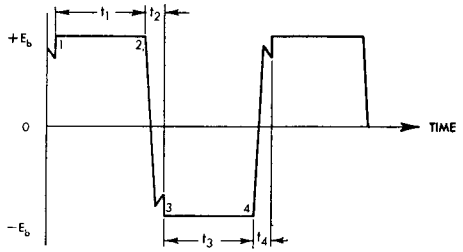

FIGURE 49

transformer and the timing capacitance varied until the wave-form characteristics have been duplicated.

Figure 49 illustrates an interesting condition of operation, which may be confused by some observers and should therefore be explained. This wave-form is that representing an interrupter type of vibrator with the output loaded, and with insufficient timing capacitance provided. It represents the loaded condition of Figure 46. The short peak and dip in the wave-form at points (1) and (3) are the result of loading being applied through the rectifier tube when the voltage has risen to a value exceeding that of the output (filter) condenser. Since no energy is being supplied by the battery as yet, the load reduces the voltage, forming the dip, until the contacts subsequently close. This wave-form can be confused with contact "chatter" on the make, but can be distinguished quickly by the simple expedient of removing the rectifier tube. If the disturbance persists, the cause probably lies in the vibrator action. If the wave-form changes to that similar to Figure 46, the difficulty is over-closure. Greater difficulty in making this determination is involved with a self-rectifying vibrator. Sharp and erratic peaks will usually occur at the make, although the over-closure loop may be present. This prevails on both load and no-load, since the load cannot be applied until after the rectifier contacts close. A positive check requires that the output load circuit, following the smoothing filter, must be opened in order to secure a no-load condition.

Figure 50 illustrates the normal wave-form appearance for a correctly adjusted self-rectifying vibrator. The timing capaci-

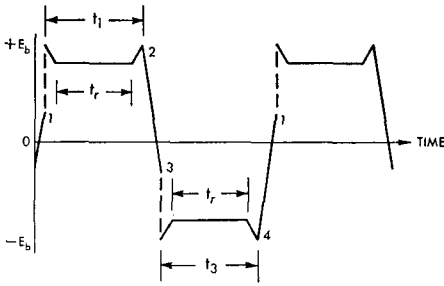

FIGURE 50

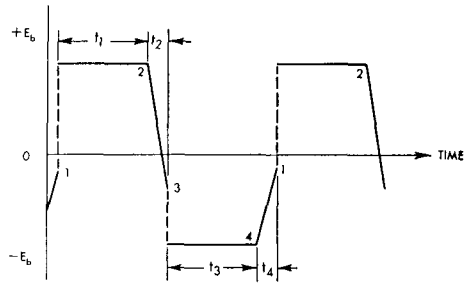

FIGURE 51

tance has been selected to give the same closure for the wave-form as was used for the interrupter type in Figure 48. Time intervals " $t_1$ " and " $t_3$ ," as before, represent the contact-closure time for the interrupter portion of the vibrator. If the vibrator were operated on no-load, the appearance of the wave-form would be identical with that of Figure 48. However, when load is applied to the output, the additional load current flowing in the transformer primary and the primary circuit will cause a voltage drop proportional to the current. The oscilloscope, being essentially a voltage indicator, will record this drop in applied voltage and impress the change on the wave-form. While exaggerated, the time intervals " $t_r$ " represent the contact-closure time for the rectifier contacts. Thus it can be easily interpreted that the peaks showing in the wave-form at the start and the finish of each half-cycle represent the total IR voltage drop measured by the voltmeter. Therefore, these peaks are a normal portion of the wave-form, on load, and should not be a reason for criticism of the vibrator.

To illustrate the meaning of "unbalance," as applied to vibrator performance indicated by the oscilloscope, several additional wave-form diagrams have been provided. Figure 51 shows a condition of minor unbalance of an interrupter type vibrator (or a self-rectifying type operating on no-load) due to necessary vibrator production tolerances. Wave-form unbalance, in this case, is represented by the difference in the percentage of closure of the two vertical portions of the wave-form; approximately 70% closure from points

(2) to (3) and 45% closure from points (4) to (1). Time intervals " $t_1$ " and " $t_3$ " remain equal, as do intervals " $t_2$ " and " $t_4$ ." Often unbalance occurs in the relative length of these intervals, which possibly will act as a self-correcting means in realizing equal percentages of closure in the vertical portions. In some cases this latter inequality is large enough to be obvious to the eye, in others special electronic measuring meters are required to measure this differential.

Figure 52 illustrates a case of closure unbalance similar to that of Figure 51, except for the case of a self-rectifying type of vibrator. The closures are approximately 65% from points (2) to (3) and 30% from points (4) to (1). Again because of the necessary tolerances in the production of vibrators, it will be a common occurrence to encounter units with a closure unbalance of this nature. There is the possibility that the long, or short, closure may occur on either of the vertical portions of the wave.

Another interesting occurrence that may be observed in the examination of oscillographic wave-forms of vibrator operation

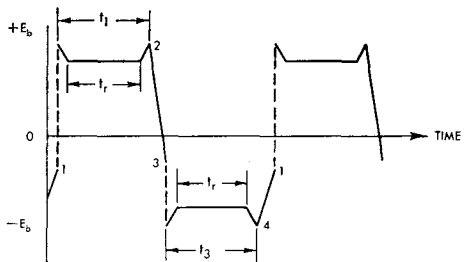

FIGURE 52

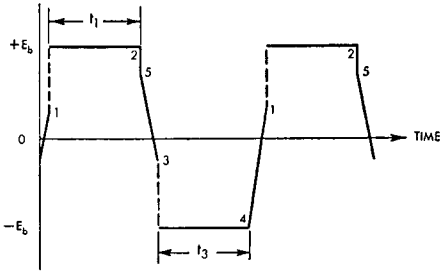

FIGURE 53

is illustrated in Figure 53. Occasionally a wave-form will be found which, while having an otherwise balanced wave-form closure, will have an apparent discrepancy appearing at one of the break points. In the figure this is indicated by the short vertical portion of the wave between points (2) and (5) before the sloping portion between (5) and (3) takes place. It will be observed that this condition occurs only on one of the vertical portions, the other, from points (4) to (1), being normal. The condition can be made to appear on the other half-cycle by the interchanging of the vibrator-transformer leads.

Investigation has identified this occasional phenomenon with those transformers having high values of leakage reactance. As discussed in the chapter on transformer characteristics, the usual connection of the several winding halves results in close coupling of one secondary half with its co-operating primary half, and poor coupling of the other co-operating pair of windings. This characteristic accounts for the appearance shown in the illustration. The half-cycle during which the load current must be commutated through the high value of leakage inductance has a transient occurring at the break as a result of the collapse of the load current in this inductance. This wave-form will be observed only on the loaded condition of operation and will disappear on no-load.

Previous discussion has been related to the connection of the timing capacitor in the primary circuit of the transformer. This is the desirable location for this component, but there are practical disadvan-

tages that make it advisable to locate the capacitor in the secondary circuit.

The usual 6-volt application requires an average value of capacitance in the primary circuit of approximately 12 to 20 microfarads. This is an excessively large capacitance to accommodate in electrostatic capacitors of even the lowest voltage rating. Electrolytic types, while small in size for the voltage required, are not satisfactory for continuous AC operation of the type involved in this service. For 12-volt service, for the same general design of transformers, the capacity required on the primary would be 3 to 5 microfarads, or one-fourth the capacity needed for 6-volt units. For 24-volt service these capacities would be  $\frac{3}{4}$  to  $1\frac{1}{4}$  mfd. Thus it can be seen that even for the higher input voltages the mechanical size of the capacitors would be large.

By connecting the capacitor across the entire secondary of the transformer, the value of the capacitance required can be greatly reduced, since the ratio of the value required on the secondary to that required on the primary is the reciprocal of the square of the turn-ratio, assuming unity-coupling.

$$(30) \quad \frac{C_2}{C_1} = \frac{1}{a^2}; \text{ where } a^2 = \left( \frac{N_s}{N_p} \right)^2$$

This results in a lower cost capacitor of a mechanical size easy to install. The higher insulation for voltage-breakdown that is required does not greatly increase the overall size. Care must be taken, however, to specify a sufficiently high voltage rating to withstand the severe service imposed upon the capacitor. A general rule that works out in most cases consists of using a voltage rating equal to about four or five times the measured no-load voltage at the highest input voltage anticipated in service. Thus, for a 400-volt reading, the rating of the condenser should be at least 1600 volts.

There are applications where it is desirable to use both a primary and a secondary timing capacitor. As pointed out in the previous chapter, all 12-volt and higher input voltages should include a portion of the timing capacitance on the primary side of the transformer. The two capacitances

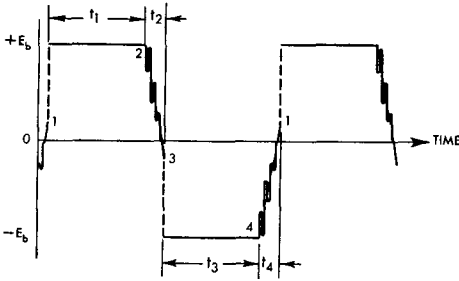

FIGURE 54

add in proportion to form a total value as related by the Equation (30). However, where an appreciable amount of leakage inductance is present in the transformer, the two capacitances are not perfectly coupled and a condition illustrated in Figure 54 results. Upon the break of the contacts at point (2), the desired oscillation of the primary inductance and the timing capacitance circuit takes place to provide for the voltage reversal to point (3) as before. The timing capacitance referred to here is the resultant sum of the primary and secondary values.

However, the leakage inductance will couple with the timing capacitor and result in a spurious oscillation of higher frequency than the desired oscillation, and is super-imposed upon the main oscillation wave. This is shown in an arbitrary way in the wave-form illustrated in Figure 54. While this characteristic is common with those circuits using both primary and secondary capacitors, it seems to cause little difficulty in the vibrator performance except at heavy loads. This may make the exact interpretation of the wave-form as to closure percentages, etc., somewhat difficult.

In order to stabilize the circuit and suppress this spurious oscillation, a resistor is placed in series with the secondary timing capacitor. The value of this resistor must be such that the critical damping resistance of the unwanted LC circuit is exceeded, while the critical damping resistance of the desired LC circuit is not reached. The values have been checked experimentally for various designs of transformers and it has been found that a wide

range of values can be used without exceeding these limits. Approximately 10,000 ohms is satisfactory for most applications, with values ranging from 5000 to 25,000 ohms being acceptable on the average. After the insertion of this damping resistor, the wave-form will again resume the appearance shown in Figures 48, 51, and 53. Under no circumstances should the resistance be placed in series with the portion of the timing capacitance placed in the primary circuit, because if a value large enough to accomplish the desired result is used, the advantage gained in suppressing the starting arc will be lost. Even when using the secondary capacitance alone, as in the case of 6-volt applications, it is wise to use the resistor in series with the capacitor, as the slight additional expense is offset by a more stable circuit and improved performance. This is especially true of the higher-flux-density designs of transformers.

Perhaps it should be pointed out at this point that when using the primary timing capacitor the wave-form will have one additional characteristic not illustrated. There will occur at the make point on each half of the cycle, points (1) and (3), a fine line peak rising a short distance above the horizontal top of the wave. This is caused by the in-rush of charging current into the primary capacitor upon the closing of the contacts. Should the damping resistor be used in series with this capacitor, these peaks would be reduced, or eliminated. However, since the purpose of the primary section is to eliminate the starting arc, the small amount of contact deteriora-

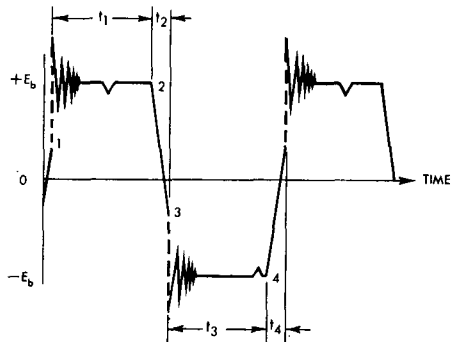

FIGURE 55

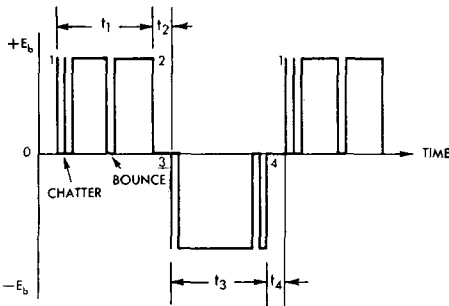

FIGURE 56

tion caused by the absence of the resistor is justified in order to accomplish this purpose.

Identification of faulty wave-forms and their interpretations is sometimes of interest. One of the most commonly observed characteristics of this nature is illustrated in Figures 55 and 56. These wave-form illustrations show the effect, in an exaggerated manner, of vibrator contact chatter and bounce. Figure 55 shows the appearance of the wave-form when operating on a transformer-timing capacitor circuit. The sharp peaks shown at the make of the vibrator at points (1) and (3) represent a condition of chatter existing in the vibrator. The sharp "V" appearing in the latter portions of intervals "t<sub>1</sub>" and "t<sub>3</sub>" represent a bounce, or "hop-off," of the contacts after they have originally come to rest and are supplying load current. Chatter is distinguished from bounce by the relative length of contact-dwell occurring between contact openings and the rapidity at which the dwell periods occur. This is best illustrated by reference to Figure 56, which shows the same vibrator as in Figure 55, but now operating upon a center-tapped resistor. The elimination of the inductance and capacitance permits the transients to appear on the oscilloscope in a more pronounced manner, resulting in greater ease of identification of their source.

The final illustration of wave-forms is shown in Figure 57, covering the characteristics of worn vibrators and improper starting. The wave-form shows the respective contact-dwell periods, "t<sub>1</sub>" and "t<sub>3</sub>," as they are affected by low amplitude and

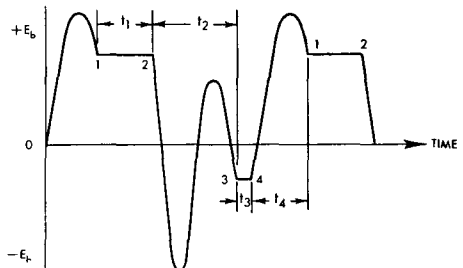

FIGURE 57

erratic contacting action. Also, it will be noted that the switching intervals, "t<sub>2</sub>" and "t<sub>4</sub>," have greatly increased in respect to "t<sub>1</sub>" and "t<sub>3</sub>." These operating characteristics have resulted in bad over-closure of the wave-form, typical of so-called "single-footing." It is quite possible that the addition of a large amount of timing capacitance to the circuit would result in the unit returning to normal operation, unless the wear has been so great as to cause the unit to be completely worn out.

### Application of the Timing Capacitor Equation to the Determination of Values for the Sample Designs

$$(28) \quad C_1 = \frac{(1 - \omega t) i_m 10^6}{8 f E_1} \text{ mfd.}$$

$$(30) \quad C_2 = \frac{C_1}{a^2} \text{ mfd.}$$

Where the values found are for 100% closure (theoretical) at the input voltage used in the equation.

### Sample Design No. 1

@ 6.3 Volts C.T.      @ 8.0 Volts C.T.

$B_m = 51,300 \text{ L/sq.in.}$        $65,200 \text{ L/sq.in.}$

$i_m = 0.38 \text{ amp.}$        $0.599 \text{ amp.}$

$\omega t = 0.85$        $0.85$

$(1 - \omega t) = 0.15$        $0.15$

$f = 115 \text{ c/s.}$        $115 \text{ c/s.}$

$C_1 = 9.83 \text{ mfd.}$        $12.2 \text{ mfd.}$

$a = 56.6$        $56.6$

$a^2 = 3204$        $3204$

$C_2 = .0031 \text{ mfd.}$        $.0038 \text{ mfd.}$

$$\text{Ratio of } \frac{.0031}{.0038} = .816$$



These calculated values are for 100% closure. Thus, if 100% closure was secured at 8.0 volts, (and all vibrator constants remained the same), 81.6% closure would result at 6.3 volts. To obtain the value required for a theoretical closure of 60% these values are divided by .6. Thus, a capacity of .0052 mfd. is required at 6.3 volts and .0063 mfd. is required at 8.0 volts. The compromise value would be .006 mfd. as compared to .006 mfd. as determined by the Standard Transformer Comparison method, which illustrates that the calculated value was very close to the required optimum.

### Sample Design No. 2

@ 6.3 Volts C.T.      @ 8.0 Volts C.T.

$B_m = 51,200$ L/sq.in.	65,000 L/sq.in.
$i_m = .650$ amps.	1.0 amps.
$\omega_t = 0.825$	0.825
$(1 - \omega_t) = 0.175$	0.175
$f = 115$ c/s.	115 c/s.
$C_1 = 19.61$ mfd.	23.77 mfd.
$a = 66$	66
$a^2 = 4356$	4356
$C_2 = .0045$ mfd.	.0055 mfd.

$$\text{Ratio of } \frac{.0045}{.0055} = .818$$

Thus, if 100% closure is achieved at 8.0 volts, 81.8% would result at 6.3 volts. Again, translating these values to those required for 60% closure, it will be found that .0075 mfd. is required at 6.3 volts and .0092 mfd. at 8.0 volts. The compromise value of .008 mfd. compares with .008 mfd. found by the Standard Transformer Comparison method.

### Sample Design No. 3

@ 1.9 Volts C.T.      @ 2.2 Volts C.T.

$B_m = 35,100$ L/sq.in.	40,600 L/sq.in.
$i_m = .208$ amps.	.236 amps.

$\omega_t = 0.825$	0.825
$(1 - \omega_t) = 0.175$	0.175
$f = 115$ c/s.	115 c/s.
$C_1 = 20.82$ mfd.	20.4 mfd.
$a = 62.0$	62.0
$a^2 = 3844$	3844
$C_2 = .0054$ mfd.	.0053 mfd.

Thus, at the low flux-densities being used in this design there is practically no change in the required value of timing capacitor over the rather narrow range of input voltages considered. If any, the change is in the reverse direction. For 60% closure, a value of .007 mfd. would apply as compared to the Standard Transformer Comparison method value of .005 mfd. In this case, a correction factor would have to be used with the calculated value.

### Sample Design No. 4

@ 6.3 Volts C.T.      @ 8.0 Volts C.T.

$B_m = 47,600$ L/sq.in.	60,400 L/sq.in.
$i_m = .326$ amps.	.543 amps.
$\omega_t = 0.85$	0.85
$(1 - \omega_t) = 0.15$	0.15
$f = 250$ c/s.	250 c/s.
$C_1 = 3.88$ mfd.	5.09 mfd.
$a = 48.6$	48.6
$a^2 = 2362$	2362
$C_2 = .0016$ mfd.	.0022 mfd.

$$\text{Ratio of } \frac{.0016}{.0022} = .727$$

The above indicates that a rather close spread of capacitance values exists in this design, and that for 250-cycle operation the value of capacitance is very small indeed, compared to 115-cycle operation. Then for 60% closure, the capacitance values are .0027 for 6.3 volts and .0037 for 8.0 volts; a compromise value of .003 mfd. could be used. This compares with the .003 mfd. value determined by the Standard Transformer Comparison method.

# Vibrator Power Supply Construction and Interference Elimination

---

■ The discussions in the previous chapters have been limited to the three primary components of the vibrator power supply system and to the influencing factors of the applications in which a majority of the vibrators are used. These applications require the conversion of a low voltage direct current to a high voltage direct current and are usually radio receivers of the automotive, home, or portable types. The general construction of the power supply, the methods of interference elimination, and the values of the associate components are important to the successful conclusion of the design. There are a few similar applications which require additional facilities from the power supply. These facilities will be discussed in this chapter.

There are some variations in the power supply requirements that are fairly simple, while others will require additional skill gained by experience in the field of vibrator and power supply design. The services of the P. R. Mallory Company's Engineering Department are available for those who wish to consult with them. These variations include such requirements as additional windings on the transformer for tube heaters, for bias voltages, etc., or even an extra winding to enable the apparatus to operate from an AC line. The factors involved where any AC load is supplied by the vibrator transformer, include the differences in the wave-form and frequency between the 60-cycle sine-wave AC, for which most components are designed, and the 115-cycle square wave of the vibrator supply. Since this AC load will probably be permanently connected to the transformer, its character will affect

the starting characteristics of the vibrator. For instance, tungsten filaments such as are used in radio tubes, or lamps, have exceedingly high ratios of hot-to-cold resistance values. While their operating load may be low, the starting load is very high, and special precautions are usually required to protect the vibrator from these starting surges. One solution would be to turn the heaters on after the vibrator has been started. Another would be to provide for a limiting resistor in series with the heater supply lead, etc., and then supplying a somewhat higher output voltage to overcome its normal drop. Other variations should also be given special consideration.

All of the power supply components, including the smoothing filter, shields, and interference filter parts, must be arranged and assembled on the chassis in the most advantageous manner. While the application requirements may have considerable influence on the lay-out, there are certain procedures that can be followed to advantage.

The amount of smoothing filter required will depend upon the requirements of the apparatus for purity of the DC output. *Because of the sharp discontinuities of the rectified DC, a capacity input type of filter is required.* Most power supplies do not supply a widely varying load, so the regulation advantage of the choke-input type of filter is not of such great importance.

Where the power supply requires efficient filtering, a capacitor-input filter with a reactor should be used. However, where size and cost of the component parts are important, a resistor type of filter may be

used. If the entire load current needs filtering, the value of the resistor must be kept low or the voltage drop in it will be excessive. However, if a large portion of the load current can be used with only a capacitor filter, this portion can be connected to the input capacitor of the filter and the remainder of the current can be supplied through a higher resistor value without incurring too great a voltage drop. This system is often employed in low-priced auto radio receivers, where the output power tube, which constitutes the large share of the load, is supplied from the input capacitor. The voltage ripple appearing on the DC will have little effect, since there is no amplification following this tube. The other tubes, which provide high amplification in the receiver, are well filtered through a comparatively large resistor and an output capacitor.

The minimum capacitance that should be used in the input section of the filter to secure proper vibrator operation is about 5 mfd. Normally, a minimum value of 10 mfd. is recommended. The output section can be any amount desired, although a value larger than 40 mfd. is seldom required. These values refer to smoothing filters such as are normally used in the high voltage supply of radio receivers. If a smoothing filter is required for low-voltage, high-current DC, such as used with tube filaments, much higher values of capacitance are necessary. In general, the required values of capacitance are approximately 1000 mfd. per DC ampere for the input to the filter, and 5000 mfd. per ampere on the output.

The power supply unit should be assembled in a compact manner to keep the leads as short as possible. *Care should be taken to keep the vibrator and the electrolytic capacitor as far away as possible from any large sources of heat such as the rectifier and power output tubes.* This is sometimes difficult, but by taking advantage of the "chimney-effect" in ventilation, and by placement of these parts near outer-case walls, the ambient temperature effects on these components can be greatly reduced.

Where the power supply is constructed on the same chassis as is the radio receiver,

care should be exercised to locate such interference producing components as the vibrator, rectifier and transformer as far away from the antenna and radio frequency portions of the set as is possible. These components must be well shielded and securely grounded to the chassis. The rectifier tube, if used, can be placed in such a location that it may be shielded sufficiently by other components so that an individual shield will not be required.

Numerous receivers have been manufactured in which the power supply was completely isolated from the remainder of receiver by a metal partition. This arrangement has been very satisfactory wherever close-fitting and securely fastened joints between the partition, chassis, and case were used.

Present assembly methods have eliminated the use of partitions above the chassis and only a shallow metal box is used below the chassis to shield the power supply wiring and RF filter components. Transformers are usually mounted in steel cases and are well shielded since unshielded transformers are potential sources of interference. There are several other very effective methods of shielding the transformer.

The vibrator is the major source of interference, but its drawn metal container is a very effective shield. It should be well grounded to the chassis, however. The most effective method of grounding is by the use of a "ground cup." This cup is riveted to the chassis with the same rivets which hold the socket. The vibrator case slides into the spring fingers of the cup as the plug base enters the socket, thereby providing an excellent RF ground. The vibrator container can be grounded through one of the base pins but this is a very poor method because of the high RF impedance through the pin and socket connections.

The RF interference filter components, especially the RF chokes, should be so located that they do not radiate interference to other portions of the receiver. Also, the output leads should not pick up radiation from the input leads or from other exposed wiring. Transformer leads should be twisted to prevent loops from being formed. Any leads carrying RF interference should

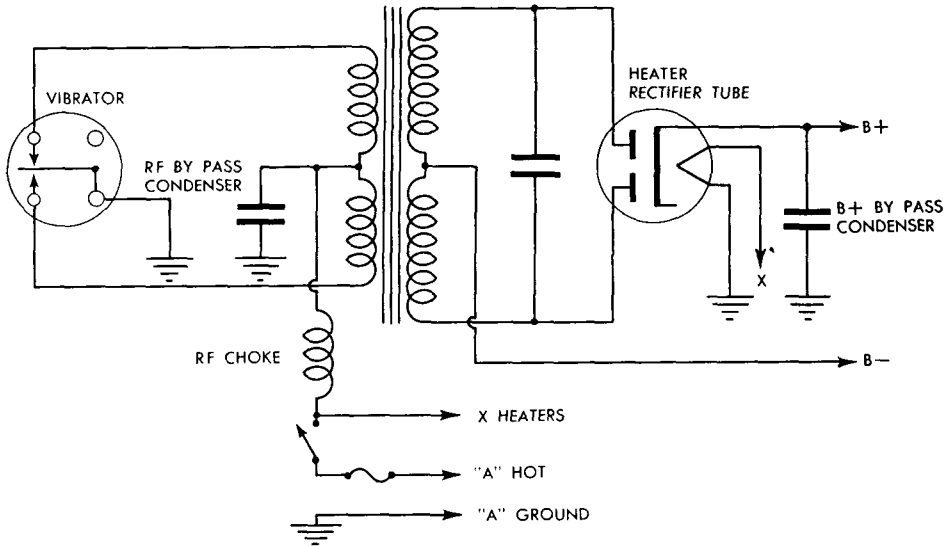

FIGURE 58

be as short as possible, and close to the chassis. Critical leads should be shielded. These are some of the important considerations in the elimination of RF interference, more commonly known as "hash."

Ground currents in the chassis and outer-case often introduce "hash" in the RF section of the receiver. These ground currents are transferred to the RF parts by currents flowing through a common path that includes at least a part of the chassis, etc. The positioning of parts and location of grounds is probably the greatest contributing factor. This is a very difficult trouble to avoid, and even more difficult to overcome. There are no rules or formula to follow for this problem. However, a few precautions may be of assistance. Avoid "loops" of any wire carrying vibrator current from being formed around any portion of the chassis, no matter how small; re-position transformer or improve shielding; check every chassis and outer-case weld, rivet and screw for good RF connection; relocate vibrator circuit grounds and also RF circuit grounds; and always connect the grounded filament lead to the socket terminal next to the grid socket terminal.

One of the most common causes of

ground currents in the chassis is the routing of transformer leads through the chassis so that the center-tap leads are through one hole while the end-taps are through another hole. Thus the entire input current circuit forms a magnetic turn around a portion of the steel chassis. The induced voltages set up circulating currents, all modulated with "hash" frequencies. As an example, the ground currents were eliminated in one receiver by sawing a slot between the two lead holes in the chassis.

One general rule that should always be followed in "hash" elimination work is that any magnetic or electrostatic shield should be closed on all sides, with good electrical and mechanical contact made in all joints. This provides a short-circuited path in all directions of current flow.

Figure 58 illustrates the typical interrupter vibrator circuit diagram, with the minimum amount of interference filtering provided. A RF by-pass capacitor is connected from the transformer center-tap of the primary to ground, and a single RF choke is provided in the "A-hot" or battery lead. For the secondary, or output circuit, a single RF by-pass capacitor is provided, although this is eliminated sometimes by the use of an electrolytic capaci-

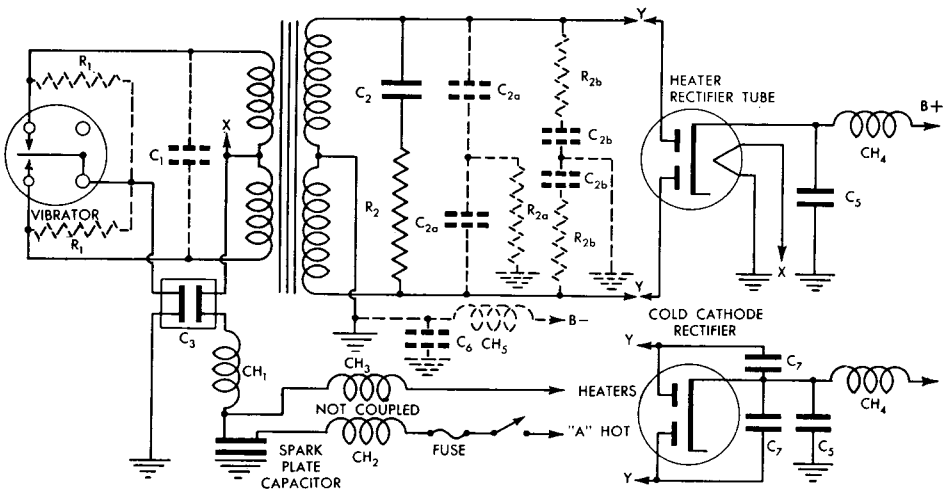

FIGURE 59

tor having low impedance characteristics.

Figure 59 illustrates improved means of "hash" filtering, with alternate means of supplying the required amount. Considering first the primary circuit, it will be noted that shown as dashed lines are two resistors connected from each interrupter contact pin on the socket to the reed, or ground, terminal. These are quite effective in eliminating a type of spontaneous transient "hash" of rather strong impulse strength known as "pop-hash" because of its intermittent character. A primary timing capacitance is also shown as an alternative which sometimes is effective. In other applications it is required because of the value of input voltage. The value of this capacitor,  $C_1$ , is usually between 0.1 and 0.5 mfd., but may be as large as 1.0 mfd. in difficult cases. The value of  $R_1$  will ordinarily be from 50 to 150 ohms for 6-volt applications. These resistances are an additional input load upon the battery, and the minimum resistance permissible depends upon wattage size of the resistor that can be accommodated in the physical space available.

The RF by-pass capacitor  $C_3$  is here shown as an improved type which has proven very satisfactory in this type of application. The unit has two tabs at each end of the foil, so that by making proper

connections, the current is conducted to the capacitor foil without any intervening length of lead being interposed. Thus, no lead inductance is inserted to decrease the by-passing action. The value of this capacitor is usually 0.5 mfd., but 1.0 mfd. may be used.

The primary RF choke,  $CH_1$ , may be of several types of construction. This is usually a layer-wound inductance of an odd number of layers, and because the current is high, the wire size should be rather large, generally from #12 to #16, to give a low voltage drop. The inductance, measured on a 1000-cycle bridge, will usually be from 8 to 30 micro-henries in this type of choke.

Several expedients have been developed to increase the inductance to a more favorable value, without increasing the voltage drop in the choke or increasing the physical size. Powdered-iron cores, which increase the inductance by as much as three or four times, and still maintain low RF losses, have been successfully utilized. It has been found that silicon-steel laminated cores are so satisfactory in this respect, and many chokes for interference elimination work have been made in this manner. This type of choke is increasingly effective in the frequency ranges below 500 kc. The disadvantage to such chokes is their higher

distributed capacitance, which reduces their effectiveness at the higher frequencies. Special "pie" wound chokes are now available and are very effective over wide frequency ranges.

If the choke inductance is too high, it will affect the vibrator performance. A value of 50 micro-henries should be the maximum for 6-volt input systems. As the input voltage goes up, and the commutated current decreases, a larger value of inductance might be tolerated. In this connection, the relay mentioned in a previous chapter as a device for improving the starting of higher-voltage vibrators, also acts as an excellent choke.

Referring again to Figure 59, it will be noted that an individual choke, CH<sub>3</sub>, has been provided in the heater circuit to prevent the introduction of "hash" into the RF section by this means. Another choke, CH<sub>2</sub>, has been provided in the battery lead, which in conjunction with the "spark-plate" capacitor, is primarily intended to prevent the entrance of automotive ignition interference into the receiver. However, it also serves to eliminate any remaining "hash" from the battery lead which might be radiated to the antenna circuit. This "spark-plate" type of capacitor is unique in that it is usually built up of ordinary materials and is assembled directly to the chassis or case in its construction. Tin-plated sheet steel and "fish-paper," or fiber, are cut and assembled to form the capacitor. The current flows in at one end of the plates and out at the other, to eliminate any inductive effects.

The power supply unit MUST be fused to insure satisfactory service. The value of the fuse must be such that under maximum input voltage conditions and loading the fuse will not over-heat and open. Neither should the resistance be so high as to cause an excessive voltage drop. However, it must be of low enough rating so that an abnormal load, such as might be caused by a shorted output tube, electrolytic or paper capacitor, or vibrator, will cause it to "blow" quickly.

The output RF choke, CH<sub>4</sub>, and by-pass capacitor, C<sub>5</sub>, are of standard construction. Because of the low current being

handled, the choke can be a universal-wound type with small-size wire. The nominal value is about 1 milli-henry, and is satisfactory for the usual frequency range of most receivers. For high-frequency RF bands, a single-layer choke of much smaller inductance will be more effective. A mica capacitor on the output of the RF filter is often desirable for better high-frequency performance.

When the heater type of rectifier tube is replaced with the cold-cathode type, such as the Type 0Z4, additional filtering may be required. The lower corner of the diagram shows capacitors C<sub>7</sub> added in the circuit when this tube is used. These are not always required but are occasionally very helpful. The values of such capacitors are approximately .001 mfd. or less.

Choke, CH<sub>5</sub>, and capacitor, C<sub>6</sub>, may be required in the center-tap lead if this is not connected directly to ground. In this case a capacitor may also be used on the output side of the choke if necessary. The loads into which the filters work will often determine the location of the capacitors in the circuit.

Timing capacitor C<sub>2</sub> and resistor R<sub>2</sub> have been shown in the manner discussed throughout the text. This system offers the smallest value of capacitance and the fewest number of components to accomplish the required duty. However, other methods of connection can be used when required.

The connections noted at C<sub>2a</sub> and R<sub>2a</sub> are one version of the alternative arrangements. In this arrangement, the two capacitors must each be twice the capacitance of C<sub>2</sub> to have the same over-all value in the circuit. Since they are in series, the voltage rating may be lower. A certain amount of hash-suppression is accomplished by connecting the resistor to ground from the center-point. This resistor could be eliminated entirely when the interrupter type of vibrator is used, but is used as shown with a self-rectifying vibrator. When used with the self-rectifying vibrator, this resistor prevents stored energy of the capacitor from discharging across the rectifier contacts, since the lead of the vibrator is at ground potential. It

will be noted that the stabilizing action of the resistor is not present in this arrangement, as the location is not in the LC circuit.

The second alternative arrangement is that shown in the version indicated<sup>f</sup> by capacitors  $C_{2b}$  and resistors  $R_{2b}$ . Here the resistors are placed in series with each capacitor and the center-point grounded. The same value of capacitance will be required in each capacitor as in the case of  $C_{2a}$ . This circuit is of importance only in the case of a self-rectifying vibrator. Here the capacitors act as point-capacitance across the rectifying contacts, with the resistors serving to dissipate the energy stored in the capacitors when the contacts close. However, with the resistances now in series with the parallel LC circuit, they will act as stabilizing factors.

The values for single resistors  $R_2$  and  $R_{2a}$  should be from 5,000 to 25,000 ohms. The values for the dual resistors  $R_{2b}$  should be from 5,000 to 10,000 ohms. The general rules for "hash-elimination" work can be summarized as follows:

1. It is advisable to originally include all possible "hash" filtering elements that

are known to be of assistance. Then with the circuit free from interference, one component at a time can be changed, or eliminated, and the point at which the interference is objectionable can be easily identified.

2. Provide complete and adequate magnetic and electrostatic shielding of the components and the complete power unit.
3. Select the proper electrical and electrostatic grounds in both the receiver and the power unit so as to avoid all coupling and radiation between the units.
4. Provide complete and adequate filtering in the leads to and from the power unit.
5. Provide correct orientation of the receiver coils and transformers, where necessary, and shields if required.

Obviously, if the power unit is intended to power equipment other than radio communication, the interference filters are not required, unless nearby radio equipment is affected by interference from the unfiltered power unit. In the event of the latter condition, then the power unit must be filtered the same as if it were powering the nearby equipment.

## Vibrator Power Supply Circuits

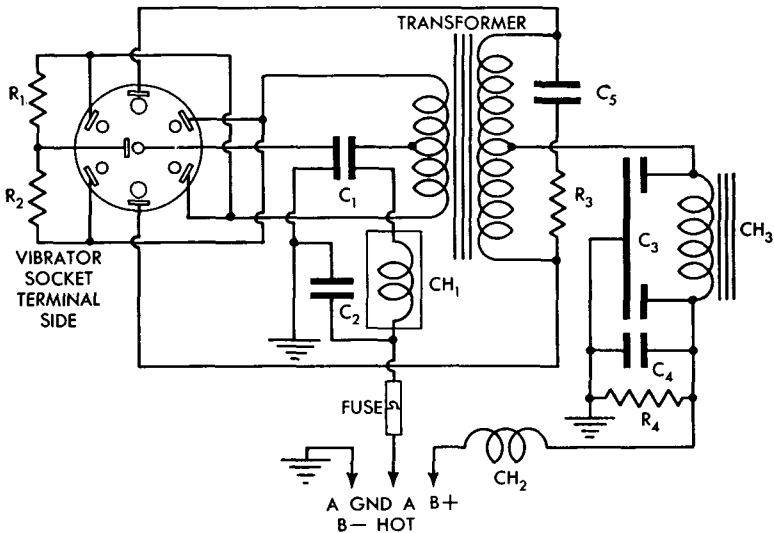

FIGURE 60

■ The following circuit diagrams are presented to illustrate a few used in various vibrator power supply applications.

Figure 60 illustrates the usual construction of a power unit utilizing a self-rectifying vibrator. The vibrator illustrated is of the "reversing" type where the contact materials used are non-polarized. The base is so constructed and wired that it can be inserted into its matching socket in two positions 180 degrees apart. By wiring the socket in a manner similar to a reversing switch, the polarity of the connections to the secondary of the transformer can be reversed with this rotation of the base, and thus the output polarity can be reversed. This provision permits the maintenance of

a correct output polarity when the input polarity can not be predetermined, such as would occur in automobile receivers made for universal application. The new 250-cycle vibrator uses polarized contacts and since the reed always must be connected to minus A, the mechanism is connected to the "reversing" base and the wires to the socket in a different manner. However, the same end results are obtained.

The usual amount of "hash" filtering is provided in resistors  $R_1$  and  $R_2$ , capacitors  $C_1$ ,  $C_2$  and  $C_4$ , and inductances  $CH_1$  and  $CH_2$ . The smoothing filter consists of electrolytic capacitor  $C_3$ , of the common cathode type, and reactor  $CH_3$ . Resistor  $R_4$  acts as a bleeder to discharge the high-



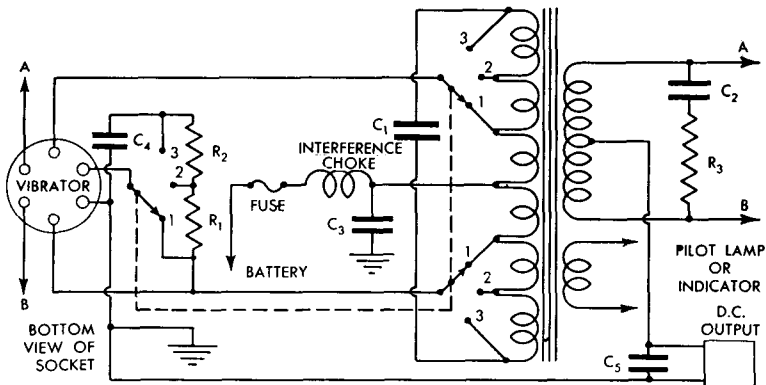

FIGURE 61

voltage capacitors, and to act as a minimum load when the unit is operated on no-load. Capacitor  $C_5$  and resistor  $R_3$  form the timing capacitor circuit.

Figure 61 illustrates an arrangement which may be utilized in some special instances such as military equipment. The circuit suggests one arrangement for operating a vibrator power unit from two or more different input voltages. In this case, provision has been made for three voltages, although the general rule would be for two; an example would be for 6, 12 or 24 volt equipped mobile vehicles, such as "jeeps," trucks, and tanks.

The transformer may be designed, as shown, with a series primary arrangement, taps being made at the appropriate number of turns for the different voltages, and with graduated sizes of wire for the different currents encountered at the various inputs. This arrangement permits greater flexibility in adjusting the primary to secure identical output with different input voltages, and permits a simpler form of switching for manual control, but it requires more winding space for the primary as various sizes of wire are required with this method. An alternate method used for two input voltages of multiple value, such as 6 and 12, or 12 and 24 volts, is for a series and parallel arrangement of primaries. Here all four primaries are constructed of the same number of turns and wire sizes; they are then connected in parallel groups of two, or in a series group of

four, with appropriate center-taps. This system permits better utilization of the winding space, but requires a more difficult switching arrangement and does not permit adjustment of the outputs by primary turn juggling.

The single vibrator is used on all voltages by bringing out the driving-coil lead, and switching an appropriate value of resistor in series with this lead as the transformer primary connections are changed. These switches are ganged for convenience. The capacitor  $C_4$  is usually required with the shunt-coil type of unit when a high value of resistance is placed in series with the coil, such as when a 6-volt unit is operated on 24 or 32 volts. The value varies, but often runs from 0.2 to 0.5 mfd. The value of  $R_1$  and  $R_2$  will depend upon the driving-coil resistance and impedance; usually a resistance value slightly higher than the resistance of the coil is required to double the operating input voltage.

The only other unusual feature of the circuit lies in the connection of the primary timing capacitor across the entire primary winding. This keeps the effect of the capacitor constant insofar as its addition to the secondary timing capacitor is concerned, and a fairly constant waveform is maintained on all input voltages. It will also serve its purpose of preventing starting arcs.

Figure 62 illustrates another type of circuit, in which the power supply is to function equally well when operating from a

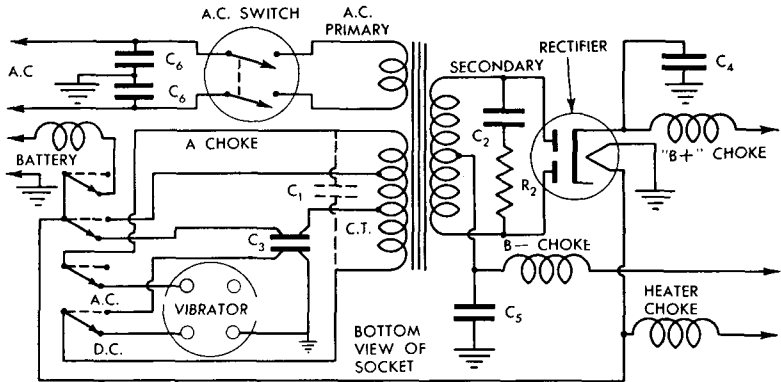

FIGURE 62

standard AC line and from a battery. This is made possible by the addition of an AC primary winding and an additional tap upon the vibrator primary so that this winding can be used for filament power when operating on AC. Because of the different form factors of the sine and the square wave-forms, if the AC primary is adjusted to provide the same DC high voltage output as is secured with the vibrator, the voltage across one-half of the vibrator primary (on AC) will be less than 5 volts, for instance, instead of 6.3 volts RMS. The actual voltage value will depend largely upon the time efficiency of the vibrator, and upon the design center for input voltage for vibrator operation. The use of the AC primary requires a much larger amination to be used in order to accommodate this added winding

The output circuit is of the conventional type, except a heater circuit filter choke has been added, since the receiver tubes must be supplied through this common lead. The input switching has two positions, one for DC, or battery, as shown in solid arrows, and one for AC as shown in dashed lines. When the connection is to the battery, the AC snap-switch is open on both sides of the line to avoid conduction of interference picked up on the transformer to the outside leads. These leads are also by-passed to ground by capacitors C6. When operating on DC, the primary connections to the vibrator are conven-

tional, with the "off-center" tap open. When switched to AC, the battery is disconnected, the lower end-tap of the primary is switched to ground, and the tube heater connection, which was formerly connected to the battery and primary center-tap, is connected to the "off-center" tap so that additional voltage is provided for the circuit.

When winding this type of transformer, the secondary and vibrator primary should be adjacent, so as to obtain the closest coupling and lowest leakage reactance.

Another means of operating vibrator power supplies on AC power lines consists of removing the vibrator and replacing it with a plug of the same basing, to which is connected an AC cord. This is attached to the interrupter contact pins of the plug, so that a suitable AC voltage may be applied to the vibrator primary. For a 6-volt power unit, the required voltage would be approximately 10.0 volts RMS across the entire primary. This can be supplied by an ordinary step-down transformer of sufficient volt-amperes capacity. This arrangement permits the design of the vibrator power supply to be made for minimum size and maximum efficiency, with reasonable cost. When there is a demand for AC operation, the additional equipment can be added.

Finally, Figure 63 illustrates a system developed originally for military equipment, but available for other uses. This

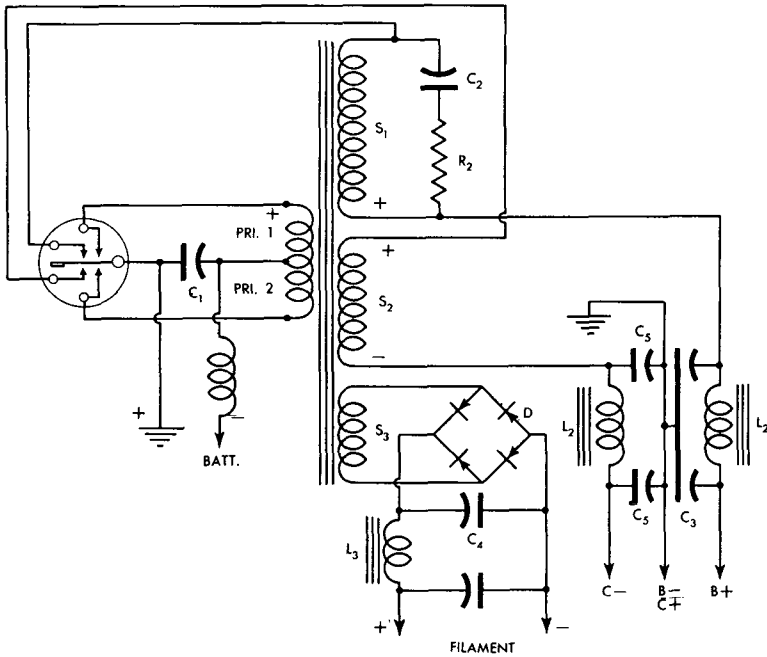

FIGURE 63

device provides for securing two output voltages, ordinarily of different values, and common at one point in the circuit (normally at ground potential). A self-rectifying vibrator of the usual type is used. The vibrator acts as a full-wave interrupter into the usual transformer primary. However, instead of serving as a full-wave rectifier as is usual, the rectifier portion acts as two half-wave rectifiers. One portion rectifies on one-half of the cycle, while the other rectifies on the other half. This permits the two outputs to be either both negative with respect to ground, both positive, or one of each, as is desired. The circuit shown has one output positive to supply a B + plate and screen circuit, and the other negative to supply a C - bias circuit. Each is filtered in a smoothing action by respective filters, as shown in the form of reactors L<sub>2</sub> and capacitors C<sub>3</sub> and C<sub>5</sub>.

This system might be desirable in securing large values of positive and negative voltages at low currents, referred to ground as a reference point. If the watts drawn from one half of the cycle are decidedly

different from those on the other half of the cycle, the magnetization of the core of the transformer will be unbalanced to a rather large degree, and unbalanced vibrator operation will result. This can be balanced by deliberately unbalancing the transformer primary by setting the "center-tap" off-center by the required number of turns to equalize the magnetizing action. The timing capacitor may be located on either of the windings of the secondary, or both. If one is to be used, the higher voltage one will provide for the smallest value of capacitance. The one to which the capacitor is attached should be closely coupled to the primary.

An additional secondary, S<sub>3</sub> is shown, together with a suitable dry-disc rectifier and smoothing filter, as an illustration of how an isolated low DC voltage output may be supplied. The load should be small compared to the other output requirements or should be comparatively low compared to the vibrator's capacity, if suitable performance is to be maintained. Such a load in this instance consists of a series of fila-

ment type electronic tubes, requiring very low current and voltage. Of course, if such a load were the only load supplied, the vibrator could supply such a rectified load, into the tank capacitor of the smoothing filter, up to the input rating of the vibrator.

Many other circuits could be illustrated, but these will give examples of the field to which vibrator power supplies may be expanded. This text is intended to convey to

engineers, students, service engineers, etc., a working knowledge of the design and operation of vibrator power supplies. The services of the P. R. Mallory Company's Engineering Departments are available for consultation on any special circuit designs. Complete information about the application, including load ratings, transformer design data, buffer capacitor selected, ventilation, etc., should be submitted.

## Inspection of Vibrators

---

■ Reputable vibrator manufacturers work closely with their customers in regard to the checking of constants for new applications and to the checking of specifications and prints. Regardless of this close relationship, misunderstanding may arise over unit rejected by the purchaser for low outputs, but which will be found satisfactory when returned to the manufacturer's inspection department. In a large number of instances it has been found that the condition of low output which seemed to be valid from the customer's viewpoint was caused by the test equipment being used. Since this test equipment is a necessary part of any receiving inspection set-up, if the inspection is to be detailed, a discussion of what constitutes a desirable arrangement of components is in order.

Through years of experience, techniques of inspection and testing have been developed which are largely fool-proof and quick, yet test for all the essential qualities necessary for satisfactory performance. These same methods of inspection must be used by both the manufacturer's and the customer's inspection departments if the two points of inspection are to be in reasonable agreement on rejections.

Figure 64 illustrates a suggested, and recommended, test equipment arrangement and circuit for an inspection department. This embodies the same general arrangement as is used by some vibrator manufacturers, and is flexible enough to permit making all needed tests. The upper portion of the illustration, (above the dashed lines), shows the components assembled as a rather elaborate vibrator power supply. The two lower blocks illus-

trate two suggested sources of power for the operation of the power unit.

The primary circuit is shown at the left of the transformer, with connections shown in heavy lines. Three vibrator sockets are shown, these being for types of vibrators in wide use at the present time; the left-hand 4-prong socket is for an interrupter vibrator, while the center and right-hand sockets are for self-rectifying vibrators with different base connections. Other sockets with their corresponding wiring connections can be installed if desired, or, adapters correctly wired can be used for extending the range of types that can be tested. A 6-prong and a 7-prong (small diameter) socket are suggested additions. If adapters are used, care must be taken to keep the resistance of the interrupter circuits low in order not to change the output readings.

All of the primary circuits shown in heavy lines on the drawing, must be wired with a large size of wire in order to avoid large values of primary-circuit resistance. It is suggested that No. 12 copper wire or larger be used for all of these connections. A low-resistance type of fuse-holder and fuse is required, to avoid incurring an excessive voltage drop at this point. One suggestion is the use of an ordinary AC screw-base fuse for this purpose because of its low resistance. However, newer types of radio fuse-holders and fuses are usually satisfactory. A 10-ampere fuse would be sufficient for protection for the average 6-volt tester, but the resistance is higher than the 15 ampere size. The latter should "blow" with a short-circuit, and therefore, should be satisfactory.

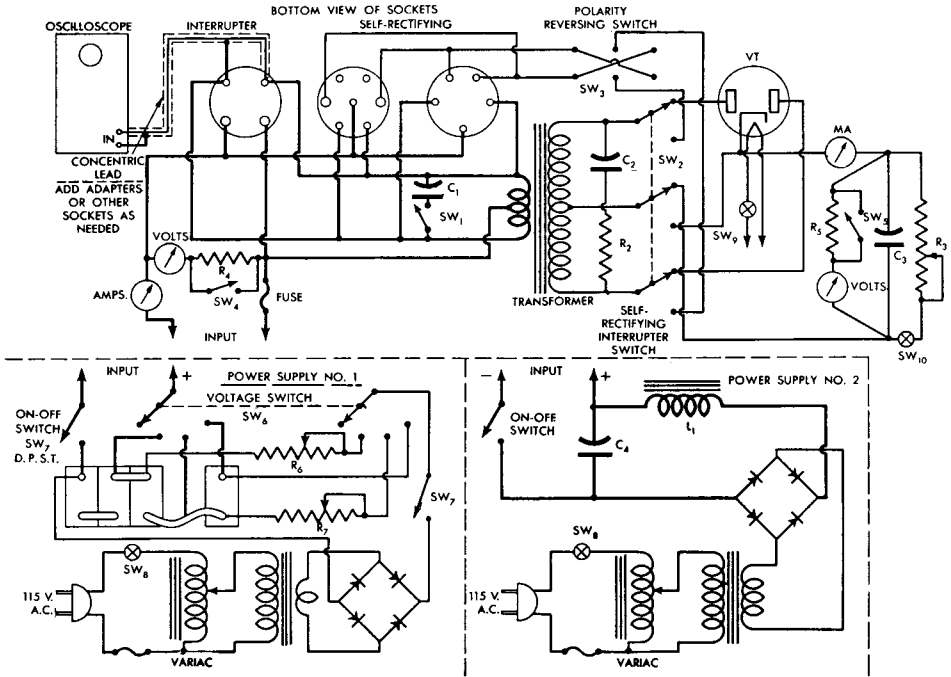

FIGURE 64

Measuring instruments in the primary circuit are shown as an ammeter in the battery lead and a voltmeter across the input circuit, together with a cathode-ray oscilloscope. The inclusion of the ammeter is optional, and since the knowledge of the value of input current is of little interest in the tests to be conducted, its omission is recommended. This simplifies the control and measuring panel, and removes a considerable amount of resistance from the input circuit. The voltmeter on the input is shown with a multiplier which can be omitted if the circuit is to be used at one nominal input voltage. The location of the connections of the voltmeter leads to the primary circuit is important. These should be connected to the center-tap of the primary and to the central-portion of the buss connecting the reed-terminals of the sockets together. The locations shown on the diagram were used for simplification of the drawing only. The vertical deflection plates of the oscilloscope should be connected by means of a concentric cable

to the interrupter terminals of the sockets.

The secondary, or high voltage, circuit is shown to the right of the transformer in comparatively light lines. The timing capacitor circuit of capacitor  $C_2$  and resistor  $R_2$  are shown connected across the entire secondary of the transformer. Should the application be for a higher input voltage, and require a portion of the capacitance to be placed on the primary side, switch  $SW_1$  can be closed, connecting  $C_1$  in the circuit. The leads to this switch and capacitor must be kept short and be fairly heavy.

The three leads from the secondary of the transformer are connected to a three-circuit, two-position switch,  $SW_2$ , having high voltage insulation, which controls the distribution of the secondary output to either the tube rectifier socket or to the self-rectifying vibrator sockets. The switch is shown thrown to the tube rectifier position. Another switch,  $SW_3$ , is optional, but may be provided as a "reversing" switch in the self-rectifying vibrator high-voltage leads to provide for the correct polarity of

output voltage.  $SW_5$ , if used, must also have high-voltage insulation. A suitable socket is provided for the tube rectifier, and an off-on switch  $SW_6$  can be provided in the heater circuit. However, removal of the tube is usually a better procedure as this prevents possible internal arc-overs when operating with a cold heater.

An adjustable load resistor is provided at  $R_3$ . This should preferably be of a 50-watt, or higher, rating, not only to keep the operating temperature low, but to assist in making accurate adjustments with ease. The value of resistance will be largely dependent upon the application, etc., but a 7500 ohm (maximum) unit would be a reasonable value for most conditions. A tank capacitor,  $C_3$ , is placed across this load and reflects on the vibrator in the same manner as the first-filter capacitor in the normal power supply. This capacitor should be of the electrostatic type, rather than of the electrolytic type, for best results since the leakage current of the latter would represent an added load current and any ageing effects would affect the accuracy of the measurements. A capacitance value of 4 mfd., with a rating of 600 volts DC, should be the minimum value used, and except for very high current loads, this value should be sufficient.

Measuring instruments in the secondary circuit consist of the output milliammeter and the output voltmeter. A voltmeter multiplier  $R_6$  controlled by switch  $SW_6$ , can be eliminated if the range of outputs to be measured is limited. For simplification purposes, the load resistor can be set to a known value of resistance, and the voltmeter eliminated. Thus, the measurement would be recorded as so many milliamperes at a load of so many ohms.

Examination of the two lower diagrams will disclose two types of recommended power supplies with which to operate the equipment. The one at the left has been in successful use for many years, and is to be highly recommended. However, it involves the use of storage batteries with the resultant care and attention that is required. The one at the right is a simplified version of an AC power supply which can be used where batteries are not desired. The ver-

sion shown will supply only one input voltage without adjustment of the AC voltage; this might be corrected by having taps on the secondary of the rectifier transformer, and have these taps selected by a tap switch in the same manner as in Diagram No. 1.

In considering Diagram No. 1, the basic source of energy is a bank of storage-battery cells, four being used in this nominally 6-volt application. Heavy leads are brought from the four-volt, 6-volt, and 8-volt terminals, and carried to one section of a two-circuit, four-position, heavy-duty tap switch  $SW_6$  as shown, the negative lead being taken to a D.P.S.T. switch  $SW_7$ , which serves as an off-on switch. The movable blades of these switches are connected to the input terminals of the equipment by heavy cable leads so that the primary circuit resistance will be held to a minimum value. The total series resistance of the input circuit from the battery terminal to battery terminal, including the voltage selective switch, the off-on switch, the fuse, the connecting cables and the wiring but not including the transformer or the vibrator, should not exceed .070 ohms for the 6-volt equipment. Measurement of such resistance values requires the use of a low range bridge, such as a Kelvin type or careful meter measurements. Reference to Figure 14 will provide information which will assist in the selection of cable and wire sizes.

In order to secure the required voltages at the measuring point in the input circuit, it is usually necessary to provide a charger of some sort with which to raise the battery voltage above its nominal value. The diagram shows a Variac-type of variable-voltage transformer which controls the AC input to a transformer-dry disc rectifier combination, that in turn supplies pulsating DC current to charge the various sections of the battery. In order to avoid separate Variac adjustments at each voltage, series resistors  $R_6$  and  $R_7$  are provided which can be adjusted for the charging requirements. Switch  $SW_7$  is provided with an additional circuit which opens the charging circuit when the on-off switch is opened. This prevents excessive variation in the

battery voltage while the vibrator circuit is off. The charging circuits are kept isolated from the power circuits by means of the second section of the switch SW<sub>6</sub>, and separate leads to the battery, and thus impose the least amount of 120-cycle ripple upon the input voltage.

A very definite reason for the extreme precautions that must be taken to avoid excessive primary circuit resistance should be discussed before continuing. Since the current delivered by the battery, or power unit, to the transformer is a series of pulses interspersed with zero-current periods, the resultant voltage drop in the primary circuit is also a series of pulses. With the voltmeter connected at the primary center-tap and the reed terminal of the vibrator, the effect of any voltage drop is to cause a slight error in the reading of the meter. The error is greater with a low time efficiency vibrator design, since the no-current periods will be a greater percentage of the total time and the reading of the DC meter will be high over this longer time, resulting in a higher average reading. The true effective voltage during the "on-contact" time will be lower than the meter reading indicates. If the circuit resistance is allowed to be made high, the value of the IR drop pulses becomes excessive, resulting in a greater error occurring. Thus, if the meter reading is set to a fixed rated value under these latter conditions, the output will be lower than would be the case if the maximum resistance were held to the recommended low value.

These conditions have very definitely been the cause of considerable difficulty in the receiving inspection departments of many purchasers until they were corrected. One practice that has been found to be more or less common is the use of a series rheostat in the battery lead as a control on the meter reading of the voltmeter at the test equipment. Where the test requirements called for a voltage of 6.4 volts, for example, this voltage was secured from four cells of battery and a dropping resistor. In some cases the control was in the form of a potentiometer across the fourth cell, which was an improvement, assuming that a low value of resistance was used. Unless

the current through the potentiometer was approximately 10 times that through the load, however, a considerable error resulted, and such currents rapidly discharged the battery.

By the system used in power supply No. 1, certain limitations are incurred in the range of voltages that can be specified for testing. This is because of the difficulty in maintaining battery voltages reasonably constant during the test. Therefore, certain basic test voltages have been developed for such circuits. Starting of new vibrators is made at a maximum voltage of 4.5 volts, and of course, if the units start at a lower voltage they are still satisfactory. The running and load test is usually made at an input of 6.3 or 6.4 volts, as this voltage can be maintained rather easily, and must be adjusted rather closely in order to determine the output accurately. The over-voltage test is made at 8.0 volts, as representative of the upper limit of voltage provided in an automobile by the voltage-regulating system.

Power supply No. 2 permits the adjustment of the input voltage to any desired value within the range of the unit. This is advantageous if voltages are desired which are in the range between those available in the battery system. However, to make the ease of testing equivalent to that of No. 1, three such rectifier units should be used, each adjusted to the desired voltage. Taps will provide different voltages, as mentioned previously, but these will have fixed ratios to the nominal test voltage. (A 3-phase AC input to the power supply will furnish a much steadier DC output with less filtering than will the single-phase construction shown.) Three heavy-duty battery-chargers, such as are supplied for auto-battery charging, could be used with a Variac type of input control and with high capacitance capacitors connected across the outputs. These capacitors must have in the neighborhood of 5000 mfd. capacitance for each ampere of output to approximate the effect of a storage battery.

Power supply No. 2 can be stabilized somewhat, also, by connected a fairly low value of resistance across the output filter capacitor, C<sub>1</sub>. This can be in the nature of



5 ohms or so, for a 6-volt supply.

As was intimated, the principal tests consist of the observation of wave-form and the electrical performance of the vibrator at various input voltages. The wave-form test provides an electrical measurement of the mechanical action of the mechanism.

The unit should start at the designated voltage, or below.

The unit should run at the rated input voltage with a satisfactory wave-form, and provide the minimum output or more.

The unit should run at the designated over-voltage input with a satisfactory wave-form.

The designated input voltages, the acceptable output voltage limits and the acceptable tolerances in wave-form are factors to be mutually determined by the supplier and the purchaser. The wave-forms illustrated in the preceding chapters may be used as a guide but should not be

set up as standards unless by previous agreement.

There has been no mention made relative to the design, type or construction of the transformer to be used in the test equipment. With the information and discussions that have been propounded in this text, the importance of this component in the test equipment can be readily understood. It would be impossible to include a recommendation for an exact design for this purpose. Again, a mutual arrangement with the vibrator supplier should determine the "standard" transformer for test use. Often a transformer of the same design as used in production can be selected as a "standard." Standard test specifications can be established by the use of a large number of vibrators that are known to be satisfactory for the purpose, and at the same time, a value of timing capacitance can be determined which will provide for average operating wave-forms.