



CUMMINGS & ASSOCIATES

*Sales Engineering Representatives*

BOX 471 DL 0-6035  
WOODLAND HILLS, CALIF.

**Westinghouse  
Hipersil® Core  
Design Engineer's Handbook**

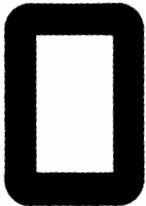

Price 1.50



## **CONTENTS**

- A. Introduction
- B. General Description
- C. General Magnetic Definitions
- D. Component Design
- E. Transformer Design Methods and Formulas
- F. Curve Data
- G. Mechanical Tolerances
- H. Assembly of Cores with Coils
- I. Core Banding Technique
- J. Appendix A—Mounting Brackets
- K. Appendix B—Core Listing



## INTRODUCTION

Hipersil tape-wound cut and uncut cores were introduced by Westinghouse in 1942. Hipersil steel is a grain oriented magnetic iron silicon alloy of very high permeability and low core loss. By continuously winding the steel into cores, the direction of magnetic flux always coincides with the best magnetic direction of the Hipersil material.

Through the years, Hipersil cores have become commonly used for many transformer and reactor components both commercial and military. Their use enables the designer to shrink the size of his component or obtain better performance characteristics.



## GENERAL DESCRIPTION

Hipersil cores are made either cut or uncut in ring or C-core form for single phase applications or E-core form for three phase applications.

single phase • type C

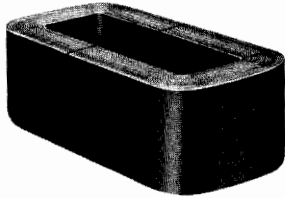

three phase • type E

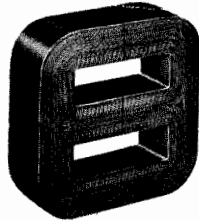

ring type

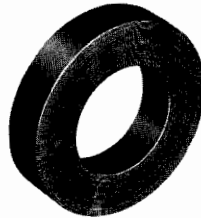

Hipersil cores are prepared by slitting the steel to width; then winding it on a form of the desired shape. They are then carefully annealed in a special atmosphere under exacting conditions to relieve stresses set up in slitting and winding. The C and E cores are next bonded in a special resin to hold the layers together. Uncut cores may be supplied as annealed or may be bonded to make the core more rigid. Bonding the core increases the exciting watts and core losses somewhat. To take full advantage of the material uncut cores are often supplied less bonding. They may also be supplied with edge-bonding or with Polyclad, a hard resin coating which completely surrounds the core and provides insulation which can be used as a base for most windings. The C or E cores are carefully cut after bonding to keep the air gap small when the halves are placed together.

Hipersil cores are available in several lamination thicknesses. They cover a wide field of application from power distribution frequencies to very high frequencies used in electronic components.

Single-phase 12-mil Hipersil C cores are commonly used at power distribution frequencies to make use of the excellent high density permeability, and low loss for conventional continuous duty designs. They can also be used to further reduce size or increase output of intermittent duty transformers—for example, those used for resistance welding or x-ray applications.

Single-phase 4-mil Hipersil cores offer the advantage of lower loss at higher frequencies and are therefore primarily advantageous in aircraft or shipboard circuits operating at 320 to 5000 cycles. Reduction in thickness has been obtained without sacrifice of permeability or saturation level, so that reductions in weight and space or improvements in operating characteristics are possible over this frequency range.

Single-phase 1 and 2-mil Hipersil C cores have found their chief application in pulse transformers and similar duty components. Here the thinness of laminations together with high space factor, permits the design of small high frequency components without sacrifice of permeability or saturation density. The excellent magnetic and loss characteristics have also proven advantageous in the design of transformers and reactors for alternating voltage applications up to 500 kc or higher. All C cores are manufactured to specifications that meet the requirements set forth in EIA standard RS 217 for wound cut cores.

Three-phase Hipersil E cores offer a solution to the problem of a small, light-weight, three-phase transformer utilizing the high permeability and low loss characteristics of Hipersil cores. Consisting of two-piece construction and three winding legs of equal cross-section, they are made in 12, 4 and 2-mil gauges to cover a wide range of frequencies.

Ring type 12, 4, 2 and 1-mil Hipersil cores offer the advantages of high permeability and low hysteresis loss without impairment caused by a magnetic joint. They offer a solution to many magnetic amplifier, reactor or current transformer problems where material quality is of prime importance.



## GENERAL MAGNETIC DEFINITIONS

### Terminology

- a. Unit Pole—a convenient concept defined so that two unit poles (m) of like kind placed one centimeter apart in vacuum will repel each other with a force of one dyne.
- b. Magnetic Field Strength or Magnetizing Force (H) one centimeter away from a unit pole in vacuum is one Oersted. Gauss showed experimentally that the field drops off as the inverse square of the distance.
- c. Intensity of Magnetization (I) is defined as the number of unit poles per unit area.
- d. Faraday introduced the concept that some magnetic properties may be likened to an endless flow along lines of induction. These "lines" would be the paths described by mobile unit poles moving in a magnetic field.

It is customary to draw these lines so that in a field of one oersted one line will pass through a perpendicular unit area.

Gauss's theorem states that  $4\pi$  lines emanate from a unit pole. The proof of this is rather simple. The field on the surface of a sphere formed by rotating a one centimeter radius about a unit pole is, by definition, one oersted. We have seen that one line passes through each square centimeter at this field strength. Therefore,  $4\pi$  lines cut the sphere, since the surface area equals  $4\pi r^2$ .

- e. Flux is the number of lines, or maxwells ( $\phi$ ) crossing a given area perpendicular to the lines.
- f. Magnetic Induction, or Flux Density is the flux per unit area. It is usually expressed in gauss. ( $B = \phi/A$ ).

g. Thus far, consideration has been given to the behavior of magnetic forces acting within a vacuum. A demagnetized iron bar may be considered as containing a large number of free north- and south-seeking poles, so arranged that they neutralize one another. If this bar is placed in a longitudinal field, unit north and south poles will move to opposite ends of the bar.

The applied field will pass easily between these infinitesimal poles and will remain unchanged. Each unit pole has, as previously discussed,  $4\pi$  lines radiating from it. Hence the total flux in the bar will be the vectorial sum of the applied and induced fields, or  $B = H + 4\pi I$  where  $I = m/A$ . The term  $4\pi I$  is referred to as the intrinsic induction.

If the poles are considered to have a random distribution over the area A, one may write  $B = \mu H$ , where  $\mu$  is a proportionality factor called the permeability.

h. Magnetomotive Force (mmf) is analogous to voltage and may be expressed (in gilberts) as:

$$\text{mmf} = \frac{4\pi Ni}{10}$$

where Ni represent the ampere-turns in a coil generating this mmf.

i. Flux may be likened to electrical current and mmf to voltage. It is natural, therefore, to reason that a parallel to Ohm's law may exist in magnetic circuits. If  $\frac{\text{mmf}}{\phi} = R$ , R will be found experimentally to equal  $\frac{l}{\mu A}$ .

The permeability,  $\mu$ , corresponds to electrical conductivity. R, comparable to resistance, is called the reluctance.

## Classification of Materials, Magnetically

Materials may be classified into various groups, depending upon their behavior in a magnetic field.

a. Diamagnetic materials are those having permeabilities less than unity. They are repelled from the poles of a magnet. Examples are the halogens, the rare gases, and the noble metals.

b. Paramagnetic materials are weakly attracted by a magnet. Their permeabilities range from 1 to about 1.1. Examples are: the alkali metals, the rare earths, and oxygen.

c. Ferromagnetic materials have permeabilities ranging into the thousands. They include the alloys of iron, nickel, cobalt, and gadolinium. Their important attributes are:

1. Permeabilities much greater than one.
2. Dependence of permeability on field and previous history (hysteresis).
3. Approach of the intrinsic magnetization to a finite limit as the field is increased (saturation).
4. Spontaneous magnetization (presence of small, intensely magnetized regions).
5. Curie point (disappearance of the above characteristics when the temperature exceeds a critical value).

## Magnetization Curve and Hysteresis Loop

If a piece of unmagnetized iron is subjected to a magnetic field, the magnetization induced in the iron may be described by a curve obtained by plotting magnetic induction  $B$  against field strength  $H$ . (figure 1.)

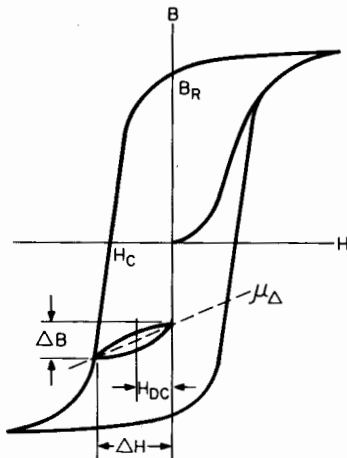

Figure 1

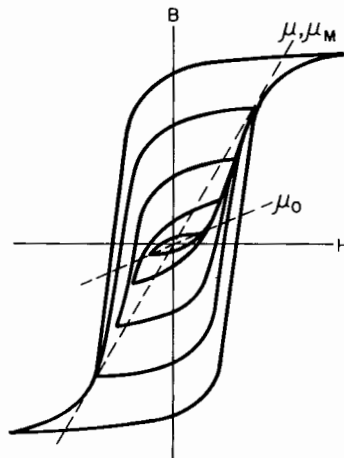

Figure 2

If the field is now decreased to zero and reversed cyclically, it is observed that the original curve is not retraced; the induction lags the field and forms a characteristic curve, called a hysteresis loop. If this alternating field is now reduced stepwise, a family of loops is obtained. (figure 2.)

The value of H for which B is zero is called the coercive force  $H_c$ . The value of induction for which  $H=0$  is the residual induction  $B_r$ ; and these values vary as the applied field is varied. When the field is sufficient to drive the iron close to saturation, these points become the coercivity and retentivity.

Saturation induction,  $B_s$ , is the ceiling value of  $B-H$  (or  $4\pi I$ ).

## Permeability

As previously stated, the ratio  $B/H$  is called the permeability. The numerical value of this ratio will vary widely, depending upon the fields applied and the previous magnetic history. Refer to figures 1 and 2.

- a. Normal Permeability,  $\mu$ , is the slope of a line drawn through the tips of a hysteresis loop formed at a specified value of H (or B). It is the ratio of the normal induction to the corresponding magnetizing force.
- b. Initial Permeability,  $\mu_0$  is the limit approached by the normal permeability as B and H decrease toward zero. It is customarily measured at 40 gauss.
- c. Maximum Permeability,  $\mu_m$  is the largest value of normal permeability attained by varying H.
- d. Differential Permeability,  $\mu_d$ , is simply  $dB/dH$  at a specified point. It is the absolute value of the slope of the hysteresis loop at any point.
- e. Incremental Permeability,  $\mu\Delta$ , is the permeability measured with superposed fields. It is of great interest in the design of reactors carrying direct current.

## Magnetization Process

a. Ferromagnetic material has long been regarded as an assemblage of tiny permanent magnets. The nature of this tiny magnet has been the subject of much consideration and conjecture. Modern theory calls it a domain—a group of atoms acting in unison. This domain is said to be spontaneously magnetized—that is, a magnetic moment is associated with it.

In a demagnetized iron bar, the domains are so arranged that their fields cancel. If an external field is applied to the bar, the domains will rearrange themselves so that a net field is produced.

b. The magnetic moment of a given domain is governed by the magnitude and direction of its magnetization, and by its volume. Changes in magnitude depend upon temperature, and—to a slight degree—upon the applied field. Ordinarily, therefore, the moment is changed by (1) an alteration in the direction of magnetization (rotation); and (2) by a change in the volume of the domain (moving boundary).

**general magnetic definitions C-4**

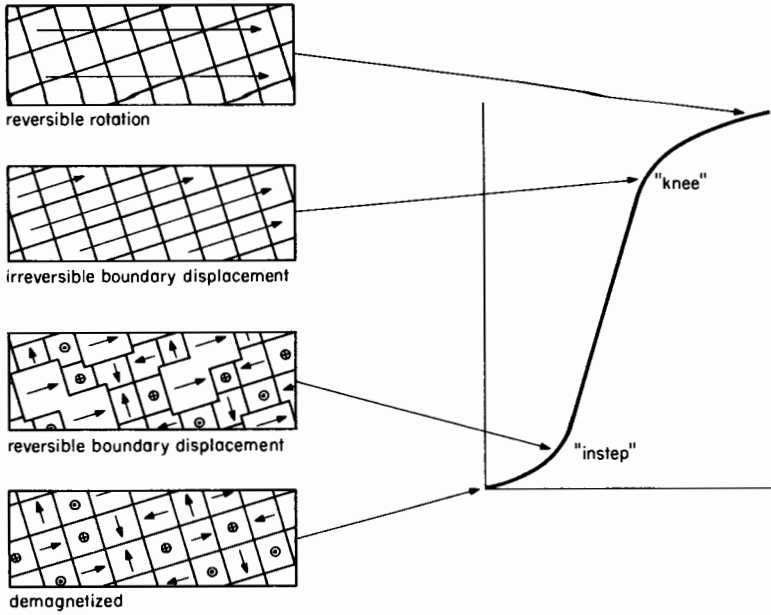

**Figure 3**

Figure 3 illustrates a highly idealized representation of possible domain orientation within an iron crystal. As an external field is applied gradually, the domains oriented in line with the field will grow at the expense to those opposed or perpendicular to it. This process is essentially reversible and corresponds to the "foot" of the magnetization curve.

As the applied field is increased still further, irreversible boundary displacement sets in, as the unfavorable domains are assimilated. The next figure illustrates the condition at the "knee" of the curve.

Still higher applied fields will effect reversible domain rotation. At this point the material becomes saturated. Stronger fields will produce no further change.

**Losses**

a. It can be shown mathematically that all the energy expended in magnetizing a piece of iron will not be recovered by de-magnetizing it. Some will be lost as heat. This loss is independent of the rate of change of magnetization and is known as hysteresis loss. It may be expressed as

$$W_h = \frac{\int HdB}{4\pi}$$

Typical values are in (ergs/cm<sup>2</sup>—cycle)

<u>Material</u>	<u>Loss</u>	<u>Induction</u>
Supermalloy	4	5,000
3% Silicon Steel	300	10,000
Alnico V	2.5 x 10 <sup>6</sup>	14,000

Steinmetz developed the empirical expression  $W_h = \eta B^{1.6}$ , which holds rather accurately for iron through the range of 5 to 15 kilogauss.

b. If a conductive specimen is subjected to an alternating magnetic field, circulating Foucault or "eddy" currents will be set up. These currents act to oppose the applied field, and their net effect is to prevent the field from penetrating immediately to the interior of the material. The induction decreases, therefore, from the surface inward.

Eddy currents give rise to an energy loss equal to  $\int \rho I^2$  over the volume of the material where  $\rho$  is the resistivity and  $I$  is the current density.

In sheets of thickness  $\delta$  subject to a sinusoidal field parallel to the sheet the eddy loss is given by

$$W_e = \frac{\pi^2 \delta^2 B^2 f}{6\rho}$$

when flux penetration is essentially complete. ( $2\pi\delta\sqrt{\mu f/\rho} < 1$ ).

Other expressions have been developed for use if this is not the case.

## Magnetic Anisotropy

Crystals of the magnetic metals are anisotropic—that is, their properties vary with direction.

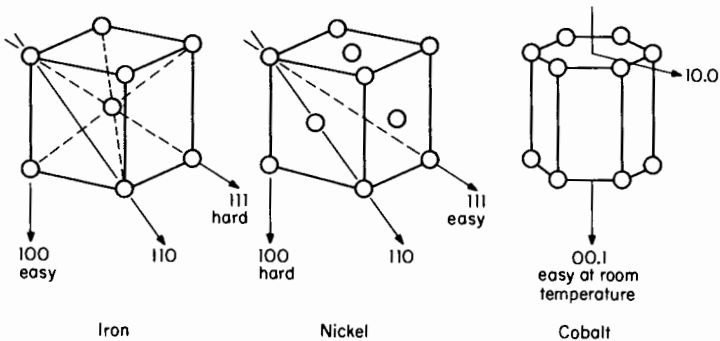

Figure 4

a. Iron is arranged in a body-centered cubic structure, as shown in figure 4. Experiments have indicated that magnetization proceeds most readily in a direction parallel to a cubic axis (100 direction), and least so parallel to the body diagonal (111). Magnetization along a face diagonal (110) is intermediate in responsiveness.

In many polycrystalline materials, the crystals are oriented more or less at random. The process of cold rolling metal sheets produces, however, some regularity in orientation; and the magnetic properties are markedly anisotropic.

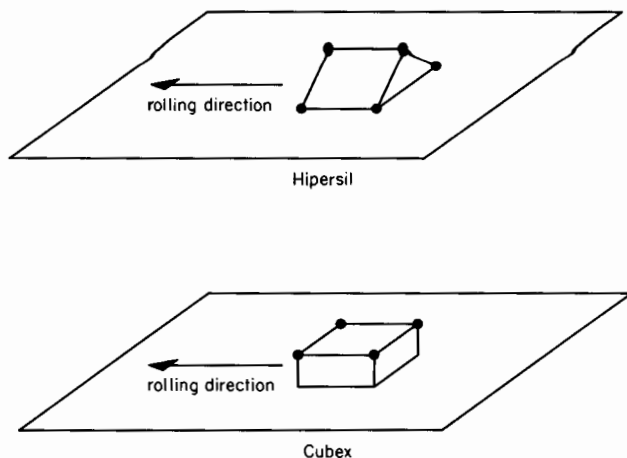

Figure 5

The crystalline structures of **Hipersil** and **Cubex** are shown in figure 5. They illustrate why **Hipersil** has a single preferred orientation; and **Cubex**, a double one.

b. Nickel is arranged in a face centered cubic lattice. Its directions of progressively harder magnetization are opposite those of iron.

c. Cobalt forms a hexagonal prismatic structure. At room temperature, the hexagonal axis is the direction of easy magnetization; but this becomes the most difficult direction above 275°C.

### Effect of an Air Gap

Gapping a core is, in effect, adding reluctances in series—the reluctance of the air gap to that already existing for the core.

$$R_{total} = R_c + R_g = \frac{l_c}{\mu_c A_c} + \frac{l_g}{\mu_g A_g}$$

As a practical example, consider an uncut ring core 2" ID x 4" OD x 1" thick. A reasonable value for  $\mu$  in silicon steel is 10,000 at 10 kilogauss. The reluctance is  $3\pi/10,000$  or .00094.

If a .005" gap is now cut in the core, the reluctance will increase to

$$\frac{3\pi}{10,000} + \frac{.005}{1} = .00594$$

—over six times its uncut value. This illustrates the importance of minimizing the gap when a low core exciting volt-ampere value is essential.

The increase in reluctance will, however, cause the magnetization curve to “shear” as illustrated in figure 6, producing a sharp increase in  $B_{max}-B_r$ . It will be shown that this is very desirable in certain applications.

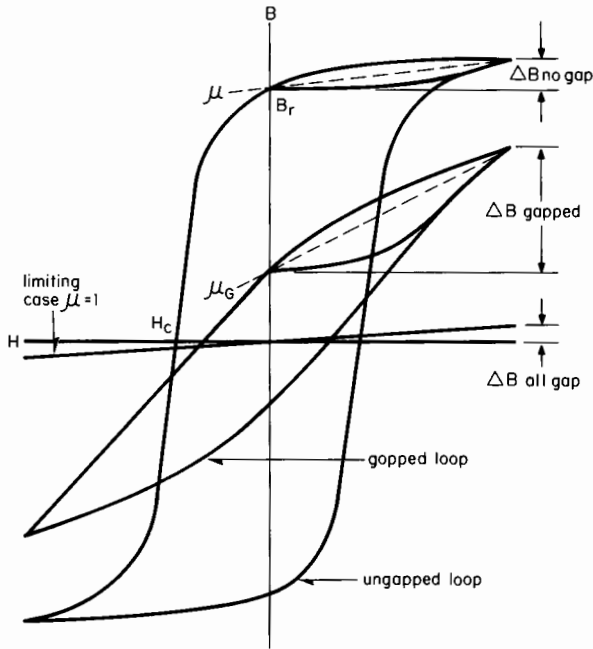

Figure 6

## Hysteresis Loop Under Special Conditions

a. Pulse. For the purpose of this discussion, we will consider "pulse" applications as those in which a core is driven by unidirectional current surges and is not biased or "reset". Under these conditions, the core will cycle over a minor hysteresis loop from  $B_r$  to some higher value (figure 6).

In order to realize maximum flux swing and pulse permeability, it is often advantageous to introduce an air gap into the core; dropping  $B_r$  to the lowest value commensurate with high  $B_{max}$ .

b. Switching. It was pointed out that low  $B_r/B_{max}$  is desirable in pulse transformer cores. Another application—the use of magnetic cores as "memory" devices—calls for the highest possible ratio of  $B_r/B_{max}$ .

Such a core may be driven by positive or negative pulses. Assume that a core has been driven to saturation by a positive pulse. It will then rest at  $+B_r$ . Successive positive pulses will drive the core from  $+B_r$  to  $+B_{max}$  and back; and the output developed will be very low.

If a negative pulse is now applied, the core will "switch" from  $+B_{max}$  to  $-B_{max}$ ; generating a high amplitude pulse in an output winding. The output is, therefore, dependent upon the direction of the applied pulses and the core's history.

The core constitutes a bistable "memory" device, ideally suited to binary digital computer applications.

c. Magamp. If a core is driven by positive pulses and "reset" or biased by an adjustable direct current, its output may be varied by changing the direct—or control—current. Under these conditions it will cycle as shown in figure 7. Since a small variation in control current usually effects a large change in output voltage—or power—the device is frequently called a "magnetic amplifier".

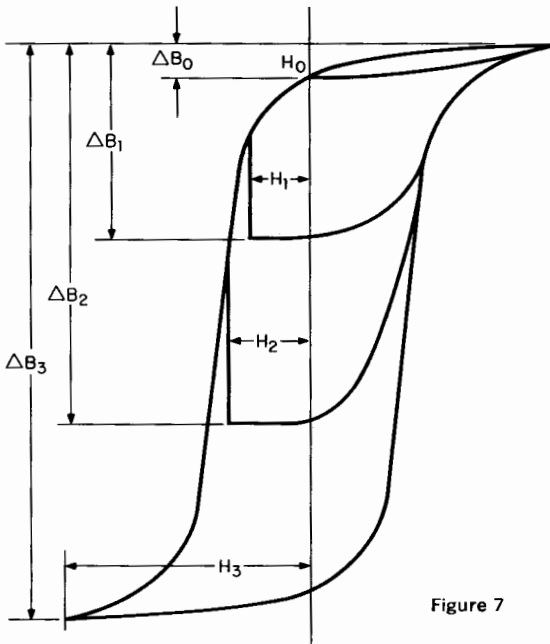

Figure 7

Desirable characteristics for such a core are:

1. High, narrow loop (high output with low control current).
2. Steep loop flanks (high gain).
3. High  $B_r/B_{max}$  (minimum output with zero bias).



## Basic Equations

a. If a conductor cuts one line per second, an electromotive force of one emu or  $10^{-8}$  volts is developed.

$$e = \frac{Nd\phi}{dt \cdot 10^8} = \frac{NA\Delta B}{dt \cdot 10^8} \quad (1)$$

Under step pulse conditions (1) becomes

$$e = \frac{6.45NA\Delta B}{10^8 \cdot t} \text{ or } \Delta B = \frac{et \cdot 10^8}{6.45NA} \quad (2)$$

Where  $e$ =peak voltage;  $t$ =time in seconds;  $A$ =area in square inches; and  $\Delta B$ =flux swing in gauss. Equation (2) is the basic formula in pulse transformer design.

Under sinusoidal conditions, (1) may be solved as

$$E = \frac{6.45 \cdot 2\pi f N A B}{1.4 \times 10^8} = \frac{f N A B}{3.49 \times 10^8} \text{ or } B = \frac{3.49 \times 10^6 E}{f N A} \quad (3)$$

Where  $E$ =RMS voltage and  $f$ =cycles per second. Equation (3) is used for calculating basic operating conditions in power transformers.

b. We have seen that  $\text{mmf} = \frac{4\pi Ni}{10}$

Field strength may be expressed as  $\text{mmf}/\text{unit length}$ , or

$$H = \frac{4\pi Ni}{10\ell} \quad (4)$$

Equation (4) is used to calculate bias for reactors and transformers carrying direct current.

c. Pulse permeability may be calculated from  $= \frac{\mu\Delta B}{\Delta H}$  or

$$\mu = \frac{\Delta B}{\frac{4\pi Ni}{2.54 \times 10\ell}} = \frac{2.02\Delta B\ell}{Ni} \quad (5)$$

Units are as above, except that  $\ell$  has been converted to inches.

d. A circuit has one henry of inductance when  $10^8$  lines link the circuit for each ampere flowing.

$$\begin{aligned} \frac{N\phi}{10^8} &= Li \\ L &= \frac{N\phi \cdot 10^{-8}}{i} = \frac{NBA \cdot 10^{-8}}{i} = \frac{\mu N A H \cdot 10^{-8}}{i} = \frac{4\pi \mu N^2 A \cdot 10^{-9}}{\ell} \end{aligned}$$

Converting to square inches and inches

$$L = \frac{3.2\mu N^2 A \cdot 10^{-8}}{\ell}$$

If the core is cut or gapped

$$L = \frac{3.2N^2 A \cdot 10^{-8}}{\ell_g + \frac{\ell_c}{\mu_c}} \quad (6)$$

This equation is widely used in the design of iron core reactors.



## COMPONENT DESIGN

### A. General

For any size parts, the number of turns determines the flux density in the iron. The fewer the turns the higher the flux density, i.e. the "harder" the core material is "worked". The wire size determines the loss in the winding while carrying current. The smaller the wire the "harder" the wire is "worked". How hard to work the iron and the copper is determined by such factors as

- a. Permissible temperature rise.
- b. Maximum regulation permitted.
- c. Specified limits, if any, on losses.

Temperature rise depends upon how hard the iron and copper are worked. It depends also upon configuration, type and size of case, potting material, encapsulation, etc. The temperature rise of the windings is usually of primary concern as it most directly affects the life of the insulation separating turns, section, and/or separate windings as well as the insulation to core, case, etc.

For some designs the iron (core) will cool the coil. In other cases the core may be hotter than the windings or be thermally blocked from dissipating heat so that heat dissipation will have to be from the winding itself. Thus the balance between how hard to work the core in relation to the winding depends also on configuration of core and coils, i.e. how the heat will be dissipated. While temperature rise often determines the size of the transformer, in some cases the voltage regulation (drop in output voltage from no load to full load) determines the size of parts. This latter is often true for the smaller ratings.

Since the area of the window is a measure of the amperes times turns, the product of the two areas is a measure of the kva rating at least for a reasonable range of ratings. It is assumed in this regard that the ratio of window to core cross section stays reasonably constant. The percent space used by insulation in the window will usually be less for a larger window since some of the insulation e.g. that from windings to case is a fixed thickness. On the other hand, as the windings get thicker, the heat has farther to travel to be dissipated, so that the hottest spot tends to increase in temperature as size increases. Putting in cooling ducts to reduce rise introduces factors that upset the size of parts required and hence affect the "relative power handling capacity" multiplier to be used to arrive at actual kva parts.

For C cores, the "relative power handling capacity" as given in the tables is the product of dimensions D, E, F, and G. For ring cores, it is the product of D, E, and  $\frac{\pi F^2}{4}$ . For E cores, it is the product of D, 2E, F and G.

### B. Type C Cores—Performance Characteristics and Tests

Curves give the necessary data for calculating transformer designs using Hipersil cores. The curves represent maximum values for finished type C cores. These cores are tested prior to shipment for core loss (true watts, TW) and exciting volt-amperes (apparent watts, AW). This exciting volt-ampere test limit includes the exciting volt amperes of the gap formed by the core butt joint.

### **SINGLE PHASE—12 MIL**

Twelve-mil Hipersil cores are available in a wide variety of sizes and shapes for use in transformers and reactors operating in the frequency range of 50 to 400 cycles per second. The induction of transformer designs can be as high as 16,500 to 17,000 gauss, at reasonable exciting currents, thereby permitting savings in size, weight, regulation or combinations of these. Losses are comparatively low even at these high inductions, thus permitting full utilization of the high induction without creating temperature problems.

### **SINGLE PHASE—4 MIL**

Loss becomes a predominant factor in core materials at frequencies higher than about 400 cycles per second.

Peak flux density could be lowered to keep losses at a reasonable value, loss being proportional to some power of B maximum. But this is a waste of material. Or, since losses increase with the thickness of material, they can be reduced by using thinner materials. However, the decreased material thickness must not be obtained at the expense of hysteresis losses or of d-c magnetic characteristics.

Four-mil thick Hipersil magnetic material in Westinghouse type C cores permits:

1. full advantage of decreased thickness in reduced losses.
2. reduced losses without sacrificing d-c magnetic characteristics.

Even in strips 0.004 inch thick, Hipersil maintains the grain-oriented characteristics so necessary to its excellent d-c magnetic properties and a grain structure which keeps hysteresis losses low.

Four-mil Hipersil in Westinghouse type C cores thus makes possible designs at high frequencies with (1) low losses, (2) low exciting current, with (3) no appreciable reduction in maximum flux density.

Its possibilities in high temperature, class H designs are outstanding, especially in the 320 to 1000 cycle range. The excellent magnetic properties of 4-mil Hipersil permit operation at flux densities as high as 17.6 kilogausses without excessive exciting current. Thus, full advantage can be taken of the ability to work at increased flux densities without the limitations of high losses and exciting currents imposed by poorer magnetic materials. Present type "C" cores can be safely used in designs having 200 C maximum temperature measured by rise in winding resistance.

The 4 mil, series Z, cores are made from very highly oriented silicon steel. Consequently, they will have lower excitation current requirements at high inductions (above 16,000 gauss). This property makes these cores particularly suitable for high temperature rise transformers and other applications where exciting current is the usual limiting design consideration. The core loss of 4-mil, series Z cores, is approximately the same as that of 4-mil, series H cores. Since the high degree of orientation provides a sharp knee to the magnetization curve, 4-mil, series Z cores also have a unique application to chokes and saturable reactors (magnetic amplifiers).

### **SINGLE PHASE—1 AND 2 MIL**

Type C cores in 1 and 2-mil Hipersil are used primarily in pulse transformers. Hipersil C cores, made from highly oriented material give excellent results in pulse transformers. These cores have excellent d-c characteristics.

The familiar, two-piece type C construction makes it a relatively simple job to assemble the core with a coil compared to the tedious process of stacking tiny thin-gauge laminations. Another advantage of the two-piece construction is that a gap can be introduced in the magnetic path to reduce the remanent flux density. The length of the inherent gap in these cores is the same as discussed for the other gauges.

The flux density in a pulse transformer core rises somewhat uniformly during the pulse to a final value at the end of the pulse defined by the equation:

$$B = \frac{E \times t \times 10^8}{N \times A \times 6.45} \text{ gauss}$$

where:

E=peak voltage

B=induction change in gauss (increment of average flux density above remanent value of B)

t=pulse length in seconds

N=number of primary turns

A=net area of the core in square inches

A large flux density change (B) during the pulse is necessary to good pulse transformer design. To accomplish this and still keep the number of turns and the area of the core small, the material used in the core should have low remanent magnetism and a high flux density saturating point. Because these features are inherent in Hipersil C cores, they are most desirable for pulse transformer work.

Pulse permeability is calculated from the formula

$$\mu = \frac{\Delta B \times L_c \times 2.54}{.4\pi N I_m} = \frac{2.02 \times \Delta B \times L_c}{N \times I_m}$$

where:

$\mu$  = effective pulse permeability

$I_m$  = peak exciting current in amperes

$L_c$  = mean length of core in inches  $= (2F + 2G + 2.9E)$

$\Delta B$  = induction change in gauss

N = number of turns

Two mil cores in the normal range of sizes when tested with a pulse of 2 micro-seconds, 400 pulses per second, and an induction of 10,000 gauss have a minimum pulse permeability of 600.

All cores are tested by effective methods and quality control measures to insure magnetic quality for different types of application. These include a-c excitation, inductance, and pulse permeability.

For high power pulse transformer applications where higher interlaminar resistance and high pulse permeability are required, Westinghouse offers a superior grade of 2-mil C cores designated by the letter "B" with a minimum of 800 pulse permeability under the conditions set forth above. These cores have several times the interlaminar resistance of regular 2 mil material. They are quoted specially at the factory and are available in all standard sizes.

One mil cores are available in the same sizes and shapes as those shown for the 2-mil cores. They are used for the shorter pulse length applications. When tested with a pulse of 0.25 microsecond, 2500 gauss flux density, and 1000 pulses per second,

the minimum pulse permeability is 300 for normal core sizes. This value may be lower for unusually small or large cores, or if the strip width exceeds one inch.

**C CORE TEST GUARANTEES**

Core	w/lb	VA/lb	watts	volt-amperes	kg	cps
A—12 mil	0.9	1.70	0.9 x lbs	1.70 x lbs+ *5.00 DE	15	60
H— 4 mil	10.0	13.1	10 x lbs	13.1 x lb +29.9 DE	15	400
Z— 4 mil	15	39.5	16.9 x lbs	45 x lbs+41.1 DE	17.6	400
L— 2 mil	2 μ seconds		10 kg—min. perm—600			
B— 2 mil	2 μ seconds		10 kg—min. perm—800			

\* 5.00 DE is for cores having a maximum allowable joint gap length of .001. For larger cores having a maximum allowable joint gap length of .002 use twice the value.

**C. Type E Cores—Performance Characteristics and Tests**

**THREE PHASE—4 AND 12 MIL**

Westinghouse has developed three phase Hipersil cores wound from the same highly grain oriented steels that are used in the manufacture of single phase "C" cores. Because of their configuration they are designated as "E" cores. They are available in 4 and 12-mil Hipersil.

The use of "E" cores results in a smaller and lighter weight three phase transformer than is obtained by the use of three single phase transformers. Although the nominal flux densities as used for single phase "C" cores apply, the losses will be somewhat greater because of third harmonics and certain unbalancing factors inherent in this type of construction. All "E" cores are tested to the following maximum limits:

material	nominal flux density	watts total	exciting va
12-mil TA	15,000 gauss	1.1 x lbs	( 2.47 x lbs)+ 8.7* <sup>A</sup>
4-mil TH	15,000 gauss	12 x lbs	(17.8 x lbs)+51.7* <sup>A</sup>
4-mil TZ	17,600 gauss	18 x lbs	(68.4 x lbs)+71.0* <sup>A</sup>

A=D x 2E or gross area of leg cross-section in square inches.

<sup>A</sup> If 2E exceeds one inch, D2E exceeds 2¼ square inches, or F is 1⅝ or more, or G is 4⅜ or more, use 17.4A for TA, 103.4A for TH, and 142.0A for TZ cores.

Note these values give the maximum total watts and va losses. Any unbalance in the volts per turn applied to one leg of a three-phase core affects the distribution of flux in the other legs and hence, the exciting va and/or watts. Even with exactly the same voltage per turn applied to each leg, there will be a variation in exciting current per leg. This is caused by variation in magnetic circuits including effective gaps at the joints. The maximum exciting va per leg will seldom be greater than one-third the total va multiplied by 1.2.

## D. Ring Type Cores—Performance Characteristics and Tests 12, 4, 2 and 1 Mil

Tape wound Hipersil ring cores are available in numerous sizes for saturable core reactor, current transformer and magnetic amplifier applications. Actual sizes vary in weight over a range of much less than a pound to several thousand pounds. The ring type gapless configuration is characterized by a high saturation density, very high permeability and low hysteresis loss.

Ring type cores will be supplied with any one of the following treatments:

untreated (U)—Magnetic values closely approximate the Epstein values of the material.

edgebond (E)—Is a specific Westinghouse Research developed process offering greater mechanical rigidity with a minimum of deleterious effect on electrical quality (usually not over 5%).

polyclad (F)—Also a Westinghouse developed and patented process providing a covering on the core which permits winding the coil directly on the core without further insulation. Magnetically this process results in slightly higher losses than experienced with edgebonded cores (10%). This is a fluidized epoxy coating capable of 1000 volt insulation test.

resin impregnated (T)—A treatment which is rapidly being superseded by either edgebonded or polyclad because of the relatively large increase in exciting current and losses due to strain effects of the resin impregnation (20-50%).

Cores are tested to assure quality. When specific guarantees are required on ring type cores, refer to Westinghouse.

### CATALOG NUMBERING SYSTEM—RING CORES

Westinghouse Hipersil ring type cores are completely identified by catalog number. The following tabulation interprets this coding system for convenient ordering. For example, RH-210E covers a Hipersil ring type core using 4 mil series H material, 210 size, with edgebond treat.

R	H	210	E
<u>designation</u>	<u>thickness of Hipersil material</u>	<u>core size number</u>	<u>type of treat or box</u>
R-ring type core	A-12-mil H-4-mil, 15 kilogauss test Z-4-mil, 17.6 kilogauss test L-2-mil M-1-mil	identifies core size	U-untreated E-edgebond F-polyclad T-resin impregnated

Other uncut Hipersil cores can be furnished in round, oval, and rectangular shapes either untreated, edgebonded, or resin impregnated. For any special electrical or mechanical requirements, refer to Westinghouse.





## TRANSFORMER DESIGN METHODS AND FORMULAS

Basically, a transformer is designed to meet some temperature rise limit, some specified maximum regulation and some maximum permissible exciting current value most economically. Actually, however, further limitations as to size, weight, and efficiency may make the final design quite different than it might be if it merely had to meet the requirements of temperature regulation and exciting current. These considerations will determine to a large extent the value of induction B, at which it is desirable to operate the core, and the number of turns and wire size which will go into the coil. Assuming that a value of B has been assigned and that a number of turns, T, has been assumed (giving volts/turn, V/T):

$$A = \frac{3.49 \times V \times 10^6}{B \times f \times T \times SF}$$

where:

V = rms volts

T = turns

B = induction in gauss

A = gross core area in square inches

f = frequency in cycles per second

SF = space factor = 95% (for 12-mil Hipersil cores)  
90% (for 4-mil Hipersil cores)

Solving this equation gives the gross core area necessary to satisfy the assigned conditions.

Checking the number of turns, wire size, amount of insulation needed and assembly clearances will give an approximation of the core window size required. From the list of standard cores, select one nearest to the calculated gross area (D x E) and estimated window size (F x G). This, then will be an approximate design.

To calculate losses and exciting current, proceed as follows:

$$\text{core weight} = KDE (2(F+G) + \pi E - 1.717R) = KDE L_c$$

where:

K = 0.262 (for 12 mil)

D, E, F, G = core dimensions

L<sub>c</sub> = mean length of core flux path

core loss (TW) = weight x TW/pound (see curve)

exciting volt-amperes (AW) = weight x AW/pound

(see curve + gap AW)

gap AW = 1.43 V/T x B x L x SF

where:

V/T = volts per turn of coil

SF = space factor (= .95 for 12 mil cores)

B = induction in gauss

L = total core joint gap length in inches

L = .001 for cores with build-up (E) of 1 inch or less and cross-sectional area 2¼ square inches or less and window width (F) less than 1½ inches and window length (G) less than 4¾ inches

L = .002 for larger cores

These are the maximum total joint gap lengths of the completed cores.

If the loss and exciting current calculated above do not meet the desired values, a new trial may be made using other values of V/T and/or B.

When the desired values are obtained, check core dimensions on tolerance drawings and proceed with final transformer design.

Figure 8 Nomograph for transformer design

Draw a line from scale A to scale F marking intersection on scale C. Draw line from this point to scale B. Intersection on scale D gives  $\ell$ .

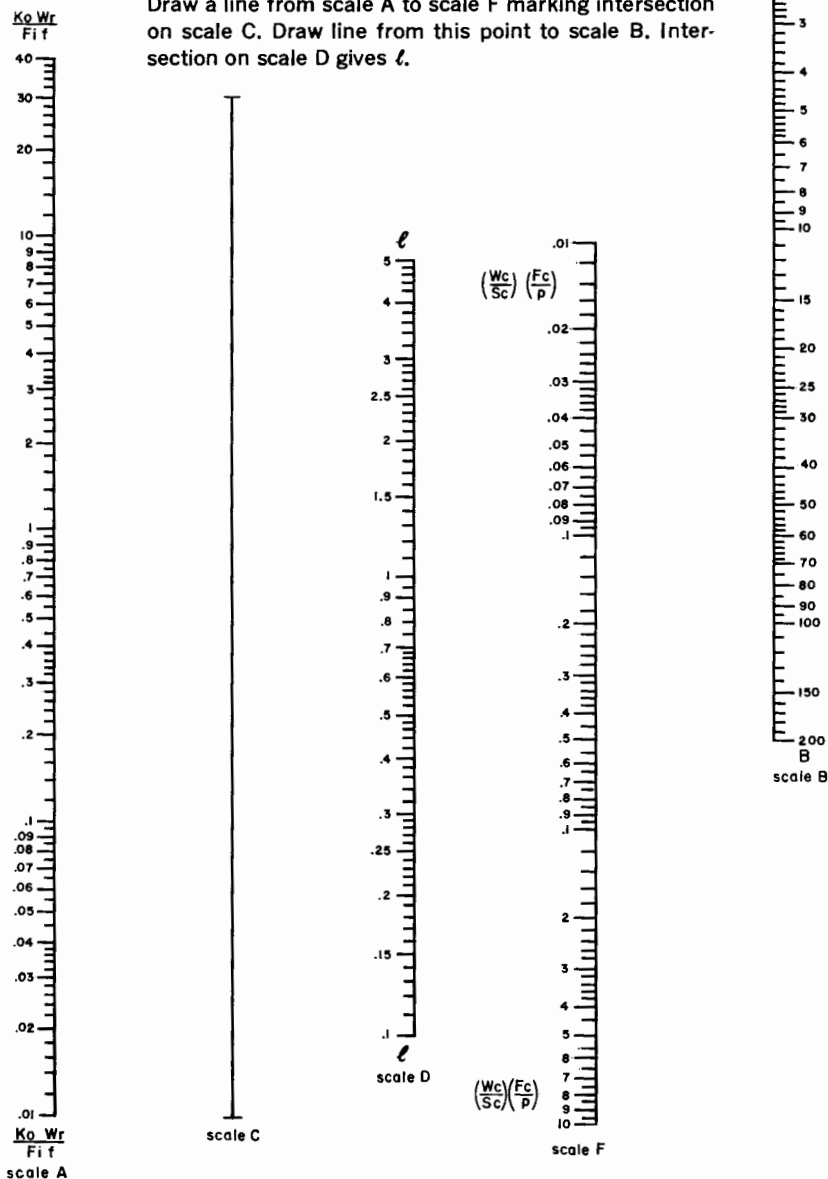

## WESTINGHOUSE DESIGN METHOD

The initial steps in design procedure are for the purpose of selecting the characteristic linear dimension ( $\ell$ ) from the nomograph. Subsequent steps then take this dimension ( $\ell$ ) and substitute it in design equations containing dimensionless constants based on core proportions. The characteristic dimension ( $\ell$ ) is selected from the nomograph by feeding in known quantities of a design. These known quantities are based on volt-ampere rating, frequency, temperature rise, working voltage, number of windings and type of iron. Supporting curves assist in supplying such quantities as copper space factor, watts copper loss per unit of coil exposed surface area, and flux density in the core. See figure 8.

### A. Selection of Characteristic Dimension ( $\ell$ )

- (1) calculate volt-ampere rating ( $W_r$ )

For filament transformers  $W_r$  is the rated volt-ampere output. For transformers with plate windings the  $W_r$  is the average between the secondary volt-ampere output and the primary volt-amperes.

- (2) calculate copper space factor ( $F_c$ )

(a) Find the equivalent volt-ampere rating  $W_r'$ .

$$W_r' = \frac{W_r}{\left(\frac{f}{60}\right)^{.76} \left(\frac{\Delta T}{40}\right)^{.63}}$$

- (b) Calculate copper space factor ( $F_c$ )

$$F_c = (.08) \log_{10} W_r' + F$$

F is taken from curve in figure 11.

- (3) calculate the quantity  $\left(\frac{K_o W_r}{f F_i}\right)$

$$K_o \text{ for simple type } \cong .796$$

$$K_o \text{ for shell type } \cong .846$$

$$K_o \text{ for core type } \cong .785$$

$$F_i \text{ for wound core } \cong .90$$

- (4) calculate  $\frac{F_c W_c}{\rho S_c}$

$$\rho = 1.15 \text{ ohm-cm (copper resistivity)}$$

$\left(\frac{W_c}{S_c}\right)$  is the watts copper loss per square inch of coil exposed surface from curve in figure 12.

- (5) select flux density (B)

(B) is selected from curve in figure 10.

- (6) Find the characteristic linear dimension ( $\ell$ ) from nomograph figure 8.

note: Instructions are given on the nomograph.

## B. Standard Cores

- (1) Refer to the lists of suggested cores in table A, depending on whether a simple, core, or shell type construction has been chosen. Select the characteristic dimension ( $\ell$ ) nearest the value found in step (6). If this value falls between two values of ( $\ell$ ) on the suggested core tables, the larger value should be selected. For the remainder of the calculations the ( $\ell$ ) selected from the suggested core tables should be used.

- (2) calculate winding exposed surface  $S_c$

$$S_c = K_3 \ell^2$$

$K_3$  is selected from suggested core table A

- (3) calculate copper losses ( $W_c$ )

$$W_c = \left( \frac{W_c}{S_c} \right) S_c$$

$\left( \frac{W_c}{S_c} \right)$  is taken from curve in figure 12.

- (4) calculate percent regulation

$$\% \text{ regulation} = W_c / W_r \times 100$$

- (5) calculate copper weight ( $M_c$ )

$$M_c = (K_4 F_c \alpha_c) \ell^3$$

$K_4$  is from suggested core table A

$\alpha_c$  copper density is .321 lbs per cubic inch

- (6) calculate turns per volt ( $N/V$ )

$$N/V = \frac{K_6}{f F_i B \ell^2}$$

$B$  is from curve in figure 10

$K_6$  is from suggested core table A

- (7) determine primary turns ( $N_p$ )

$$N_p = V_p \left( \frac{N}{V} \right)$$

$V_p$  is the primary rms voltage

- (8) calculate secondary turns ( $N_s$ )

$$N_s = \left( 1 + \frac{\% \text{ Regulation}}{100} \right) (V_s) (N/V)$$

$V_s$  is the secondary rms voltage under rated load conditions

- (9) calculate core loss ( $W_i$ )

$$W = (\text{watts/pound}) (M_i) (1.25)$$

Watts/pound from core loss curve in figure 9

$M_i$  is core weight from suggested core table A

- (10) calculate exciting volt-amperes ( $W_{ex}$ )

$$W_{ex} = W_{ex \text{ iron}} + W_{ex \text{ butt-joint}}$$

- (a)  $W_{ex \text{ iron}} = (\text{apparent watts/pound}) (M_i) (1.25)$

Apparent watts/pound from core loss curve in figure 9

- (b)  $W_{ex \text{ (butt-joint)}} = \frac{(.221) (B) (V_p) (F_i)}{N_p}$

- (11) calculate circular mils per ampere (CM/A)

$$\text{CM/A} = \sqrt{\frac{\ell}{\frac{F_c W_c}{\rho S_c} (K_5) (F_c)}}$$

$K_5$  is from the suggested core table A

$F_c$  was previously calculated in paragraph A.(2)

- (12) determine primary volt-amperes

$$\text{Pri volt-amperes} = (W_r + W_c + W_i) + jW_{ex}$$

- (13) calculate primary current (
- $I_p$
- )

$$I_p = \frac{\text{Primary VA}}{\text{Primary Voltage}}$$

- (14) calculate primary wire size

$$\text{Circular mils of primary wire} = \text{CM/A} \times I_p$$

Use wire size .... Awg of .... circular mils

- (15) calculate wire size for each secondary

$$\text{Circular mils of secondary} = (\text{CM/A}) (I_s)$$

Use wire size .... Awg of .... circular mils

transformer design methods and formulas E-6

Table A—Constant for Design Equations

core dimensions in inches				weight in lbs	l	constants for design equations					
D	E	F	G			K <sub>0</sub>	K <sub>1</sub>	K <sub>2</sub>	K <sub>3</sub>	K <sub>4</sub>	K <sub>5</sub>
<b>SIMPLE TYPE</b>											
1/4	1/4	1/4	1/4	.0455	.3515	.765	4.58	16.35	9.56	973	39,600
1/4	1/4	1/4	1	.1024	.444	.766	4.85	15.05	8.84	975	35,500
1/4	1/4	1/4	1 1/2	.1062	.452	.762	4.8	15.5	8.94	969	36,600
1/4	1/4	1/4	1	.176	.52	.781	5.19	13.35	8.15	994	31,180
3/8	3/8	3/8	1 1/2	.199	.56	.794	4.58	14.9	9.39	1010	36,600
3/8	3/8	3/8	1 3/4	.362	.669	.745	5.0	15.45	8.64	947	35,700
3/8	3/8	3/8	1 3/4	.388	.705	.765	4.58	16.35	9.56	973	39,600
3/8	3/8	3/8	1 1/2	.548	.776	.766	5.26	15.3	9.15	975	33,000
1/2	1/2	1/2	1 1/2	.607	.825	.784	4.43	15.75	9.95	996	44,100
1/2	1/2	1/2	1 3/4	.816	.881	.771	4.85	14.7	8.74	980	35,100
1	1/2	1/2	1 3/4	.851	.928	.762	4.8	15.5	8.94	969	36,600
1 1/4	1/2	1/2	2 1/4	1.205	1.026	.776	4.67	15.4	9.28	988	37,100
1 1/4	3/4	3/4	2 1/4	1.7	1.126	.751	4.9	15.63	8.83	955	36,600
1 1/4	3/4	3/4	3	1.79	1.152	.743	4.86	16.4	9.02	945	38,100
1 1/4	3/4	3/4	3 1/2	2.42	1.303	.766	4.51	16.55	9.76	961	40,400
1 1/2	3/4	3/4	3 1/2	3.1	1.388	.752	4.74	16.2	9.16	955	38,300

<b>CORE TYPE</b>											
1/2	1/2	1/2	1/2	.0274	.28	.68	5.27	14.08	6.46	865	30,100
1/2	1/2	1/2	1 1/2	.041	.33	.707	4.78	14.3	7.08	900	35,000
1/2	1/2	1/2	1 3/4	.070	.378	.695	5.15	13.71	6.47	883	30,750
1/2	1/2	1/2	1 3/4	.0946	.43	.696	4.96	14.1	6.84	886	33,000
3/4	3/4	3/4	1	.154	.507	.706	4.91	13.84	6.89	899	32,800
3/4	3/4	3/4	1 1/2	.233	.582	.715	4.86	13.66	6.98	910	32,600
3/4	3/4	3/4	1 1/2	.309	.627	.691	5.14	13.83	6.62	878	31,800
3/4	3/4	3/4	1 3/4	.382	.681	.706	4.98	13.61	6.79	897	31,800
1	3/4	3/4	1 3/4	.402	.697	.698	4.9	14.28	6.97	889	33,300
1	1/2	1/2	1 1/2	.585	.778	.70	5.08	13.6	6.68	890	31,200
1	1/2	1/2	1 3/4	.74	.844	.702	5.04	13.6	6.72	895	32,000
1 1/4	1/2	1/2	1 3/4	.884	.906	.717	4.86	13.7	7.01	911	32,700
1 1/4	3/4	3/4	2	1.25	1.014	.702	4.91	13.85	6.88	895	32,800
1 1/4	3/4	3/4	2 1/4	1.65	1.097	.682	5.2	14.21	6.62	867	31,440
1 1/2	3/4	3/4	2 1/4	1.975	1.19	.706	4.77	14.4	7.19	897	34,400
1 1/2	3/4	3/4	2 1/2	2.76	1.322	.713	4.96	13.45	6.85	905	32,100

<b>SHELL TYPE</b>											
1/2	1/2	1/2	1/2	.0382	.286	.85	2.42	7.88	9.14	1080	36,700
1/2	1/2	1/2	3/4	.0618	.336	.84	2.48	7.42	9.5	1069	38,400
1/2	1/2	1/2	1	.0722	.348	.828	2.49	6.95	9.89	1052	41,000
1/2	1/2	1/2	1 1/4	.1312	.426	.834	2.39	7.64	9.07	1061	36,900
3/4	3/4	3/4	1 1/2	.224	.504	.84	2.29	8.16	8.68	1069	34,300
3/4	3/4	3/4	1 1/2	.26	.545	.843	2.51	7.16	9.88	1071	40,000
3/4	3/4	3/4	1 3/4	.382	.61	.854	2.42	7.96	9.16	1086	36,100
3/4	3/4	3/4	1 3/4	.424	.634	.837	2.46	7.38	9.5	1064	38,900
1	1	1	1 3/4	.528	.685	.834	2.482	7.18	9.7	1060	39,800
1	1	1	2	.658	.741	.85	2.75	7.28	9.86	1080	39,800
1	1	1	2	.876	.806	.857	2.42	7.88	9.45	1090	36,700
1	1	1	2 1/4	1.068	.87	.849	2.475	7.46	9.66	1080	38,400
1 1/4	1 1/4	1 1/4	2 1/2	1.308	.937	.852	2.536	7.35	9.94	1082	39,650
1 1/4	1 1/4	1 1/4	2 3/4	1.968	1.06	.852	2.48	7.5	9.7	1082	38,400
1 1/4	1 1/4	1 1/4	3	2.36	1.15	.864	2.61	7.23	10.0	1098	40,600
1 1/2	1 1/2	1 1/2	3 1/4	3.224	1.245	.845	2.45	7.66	9.3	1075	37,500

- SYMBOLS USED**
- W<sub>r</sub> rating, volt-amperes
  - F<sub>c</sub> copper space factor
  - F<sub>i</sub> iron space factor
  - B flux density, kilolines per square inch
  - f frequency cycles per second
  - A<sub>c</sub> window area, square inches
  - A<sub>s</sub> core cross-sectional area, square inches
  - V rms potential, volts
  - ΔT temperature rise, degrees centigrade
  - l characteristic linear dimension, inches
  - ρ conductor resistivity, microhm-inches
  - I rms current, amperes
  - W<sub>c</sub> winding loss, watts
  - N turns of a winding
  - W<sub>i</sub> core loss, watts
  - W<sub>ex</sub> exciting voltamperes
  - M<sub>c</sub> copper weight, lbs
  - M<sub>i</sub> iron weight, lbs
  - K<sub>0</sub>, K<sub>1</sub>, K<sub>2</sub>, K<sub>3</sub>, K<sub>4</sub>, K<sub>5</sub>, K<sub>6</sub> are constants used with design equations
  - α<sub>i</sub> density of iron, pounds per cu. in.
  - α<sub>c</sub> density of conductor, pounds per cu. in.
  - S<sub>c</sub> exposed area of coil surface, square inches

Figure 9 Core loss and a-c excitation

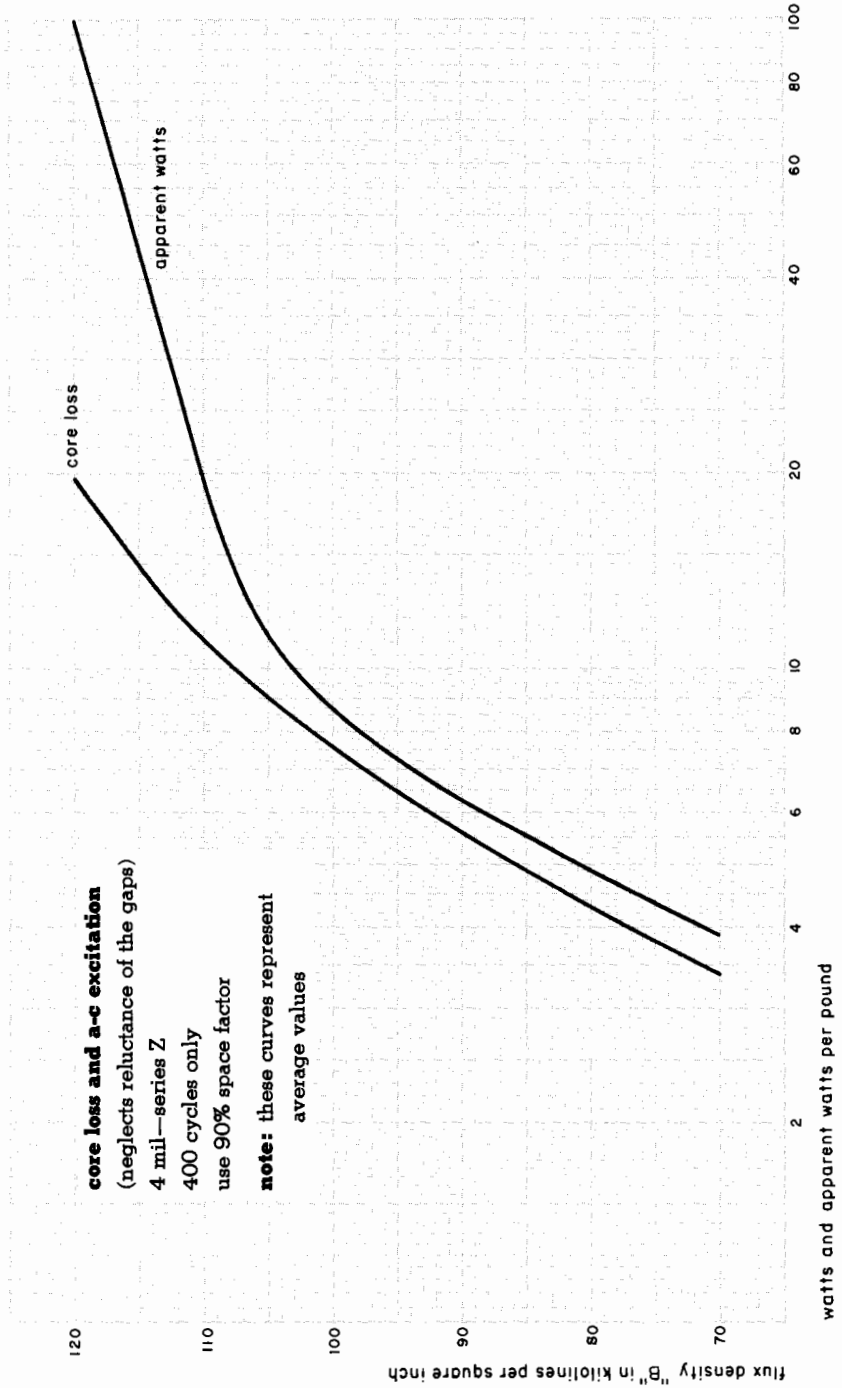

Figure 10 Volt ampere rating and flux density

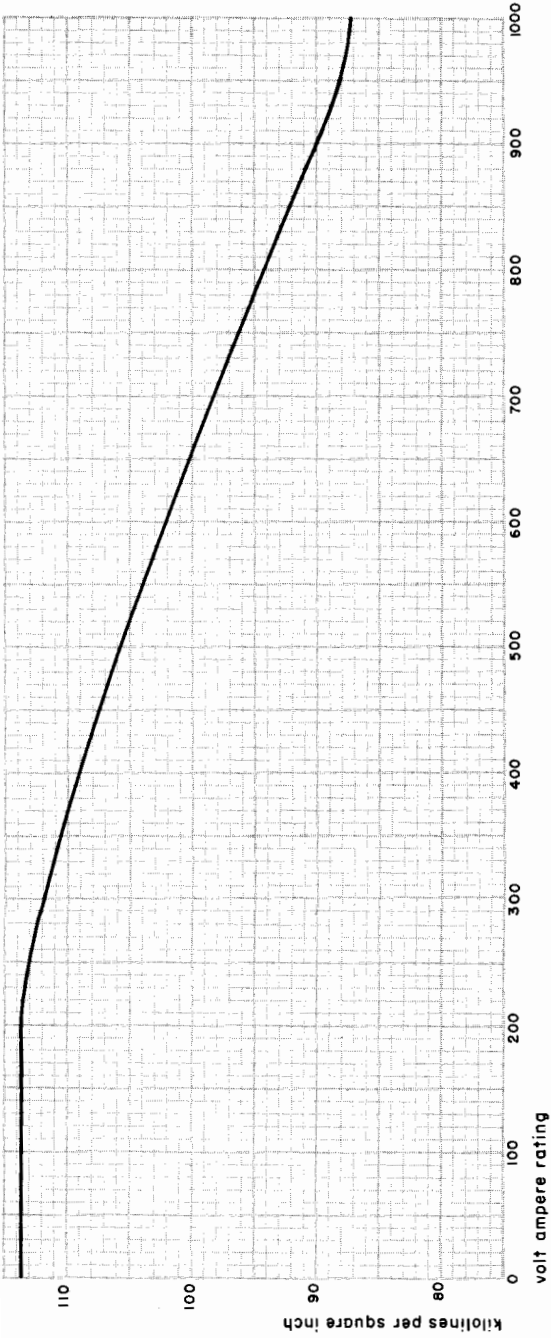



Figure 11 Winding space factor

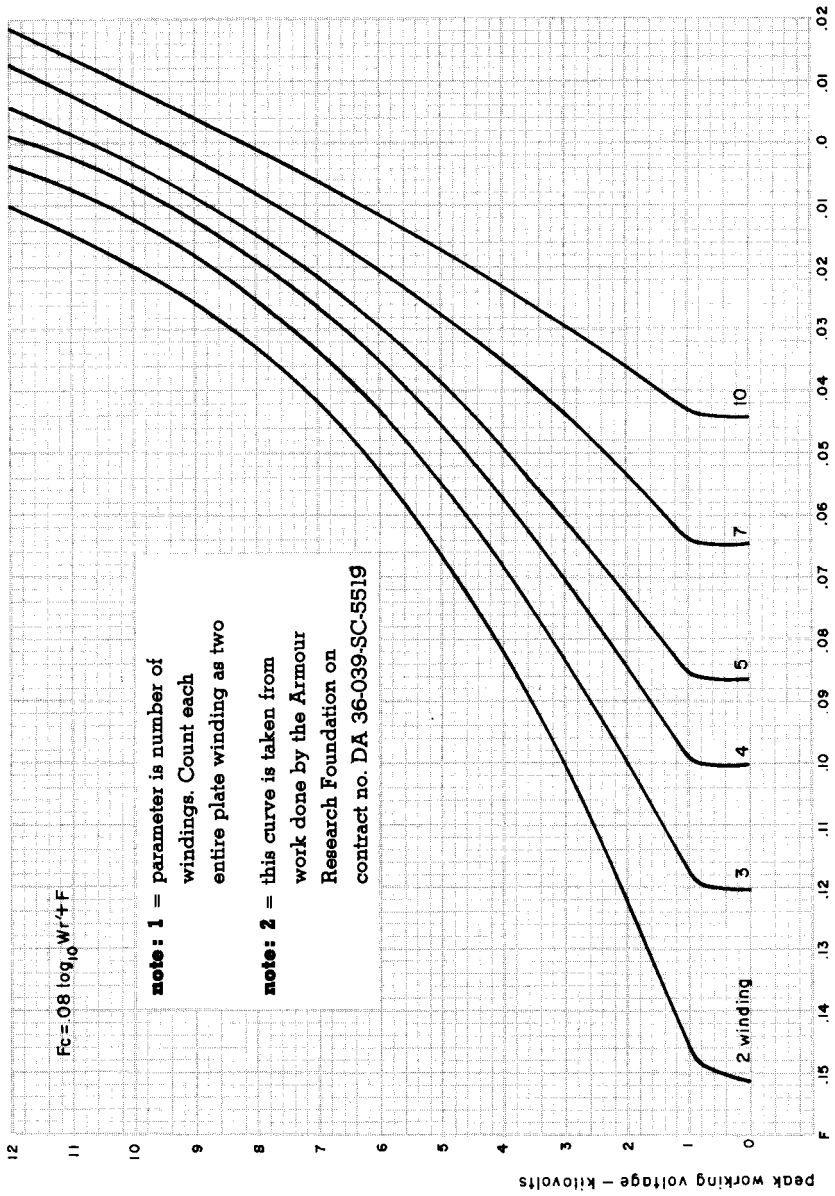
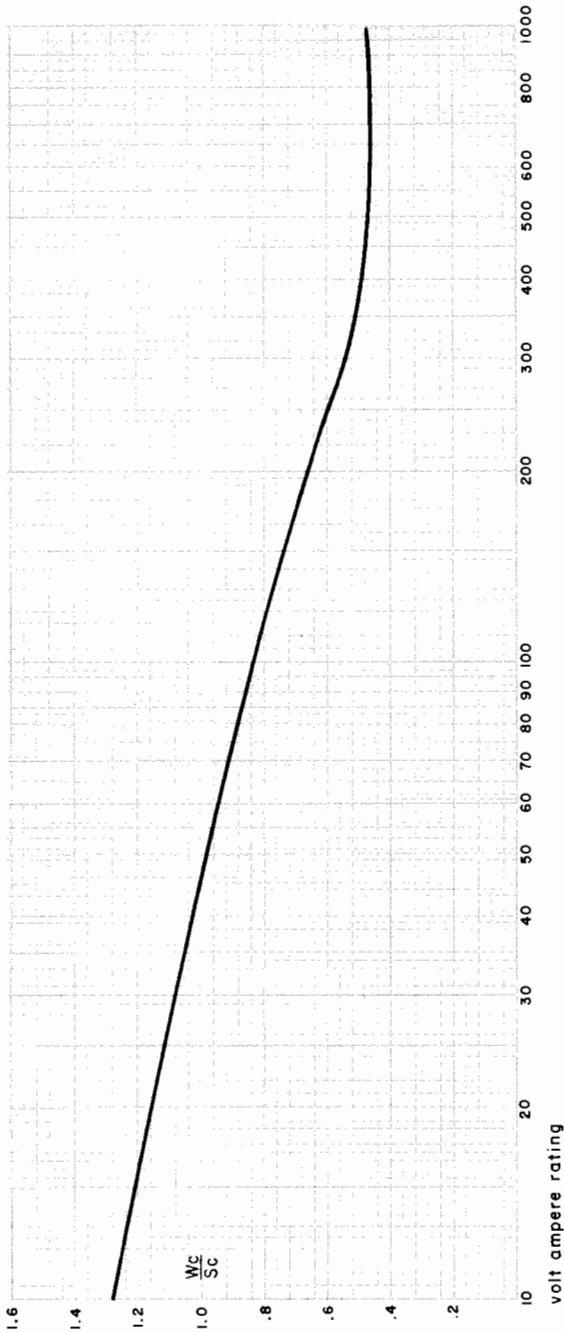

Figure 12 Copper loss per square inch of exposed surface



## FILTER REACTOR DESIGN METHODS AND FORMULAS

The design and choice of core for reactors depend upon three inter-related factors:

1. desired inductance
2. direct current
3. alternating volts

The type C Hipersil core lends itself very well to these applications because the air gap can be regulated or set to any desired value and because the incremental permeability is comparatively high even at high d-c inductions. The inductance of an iron-core reactor is dependent on the effective length of the magnetic path. This effective length is the sum of the air gap and the ratio of core mean length to incremental permeability.

$$L = \frac{3.2 \times T^2 \times A \times 10^{-8}}{lg + \frac{lc}{\Delta\mu}}$$

where:

L = inductance in henries

T = turns

A = gross core area in square inches

lg = effective air gap length in inches

lc = core mean length in inches

$\Delta\mu$  = incremental permeability

The value of  $\Delta\mu$  depends on the values of alternating and direct flux densities in the core. The sum of these densities should not exceed saturation value. Incremental permeability is shown by curves (figures 16, 24, and 29) at various values of Hd-c (oersteds of direct mmf on the core) for different values of alternating flux densities.

A designer must select a combination of core area, air gap length and number of coil turns necessary to give the proper inductance, maintaining values for Bd-c and Ba-c which will not cause magnetic saturation and which will permit the highest inductance for a given volume of core material used. The core opening size will depend on the turns, wire size and insulation requirements.

For reactors carrying direct current and operating at very low alternating flux densities, a simple design method was originated by C. R. Hanna ("Design of Reactances and Transformers which Carry Direct Current," Jour. A. I. E. E., vol. 46, Feb. 1927, p. 128). A more detailed treatment of the design of reactors is presented in "Electronic Transformers and Circuits," by Reuben Lee, John Wiley & Sons, 1955.

## BALANCING TRANSFORMERS USED WITH SILICON RECTIFIERS

Balancing transformers, as a means of forcing proper current balance, have been the subject of several technical papers and articles. Their effectiveness has been well established. These balancing transformers, or reactors as they are sometimes called, consist of laminated iron cores, usually with single turn primary and secondary windings. The currents from two cells in parallel pass through a core in opposite directions, and an unbalance between the two currents will induce a voltage which tends to correct the unbalance.

Varied designs and mechanical arrangements of cores have been used but will not be discussed here. Figure 13 is a pictorial view of an arrangement of hipersil iron "C" cores.

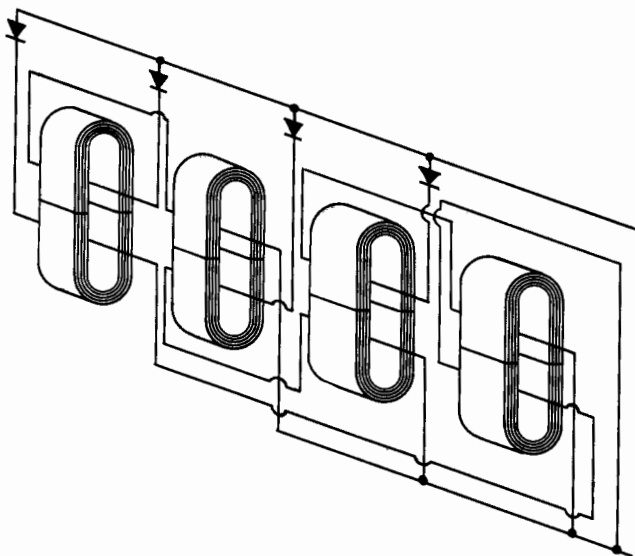

Figure 13 Hipersil iron "C" cores connected in a "chain" arrangement with four cells in parallel.

A core area of one to one and a half square inches has been found effective in reducing the unbalance between high power cells in parallel. An effective air gap of at least .001 inches should be retained in the core to reduce the possibility of saturation. The unbalance may be reduced to less than ten percent of the average current per cell with as many as six cells in parallel. With up to six cells in parallel, the cells should be operated at 90 per cent of their rating; with seven to ten cells in parallel, 85 per cent of their rating; and with 11 to 20 cells in parallel, 80 per cent of their rating. In any design, current division among the cells should be measured to assure proper balancing. This may be done quite simply by inserting a shunt in place of the fuse. If the fuses are calibrated and checked for uniformity the voltage drop across the fuses will be an indication of the current division. It may not be desirable to place more than 20 cells in parallel, unless a separate transformer is used for each group of 20 cells.

Separate transformers or transformer windings may be used to supply a number of assemblies each with only one cell in parallel. Then the output of these assemblies may be connected in parallel. If separate transformer windings are used, care must be taken in the transformer design. Multiple windings on any one transformer core will not necessarily have the identical leakage reactances required to force division of current between assemblies.

If a series parallel arrangement of rectifying cells is necessary, no set rule exists which will determine whether the seriesing or the paralleling should be done first. Each has its advantages and disadvantages, depending upon the heat sink design, required fusing, necessary reliability, etc. Individual applications will determine which is most economical or practical.



## CURVE DATA

Figure 14 Core loss curve • Single phase • 12 mil

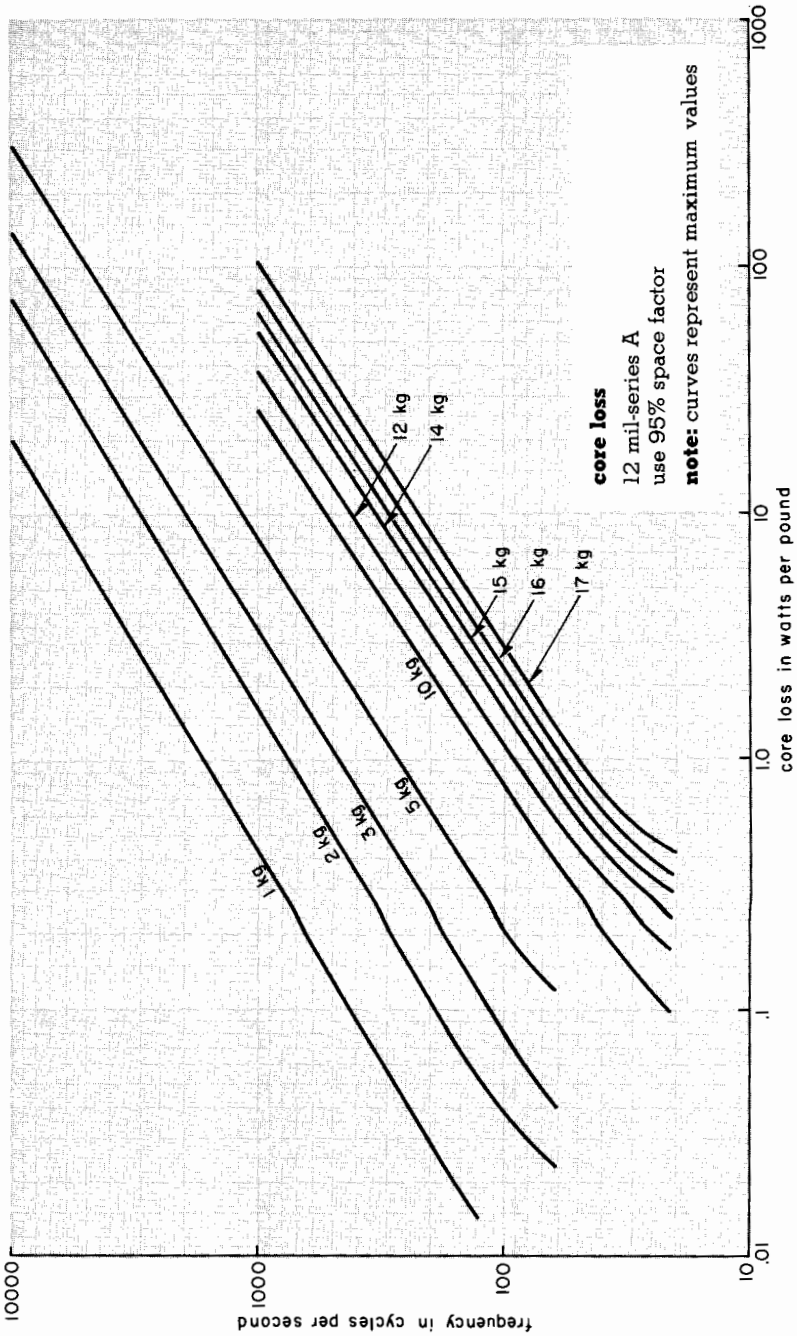



Figure 15 A-c excitation curve • Single phase • 12 mil

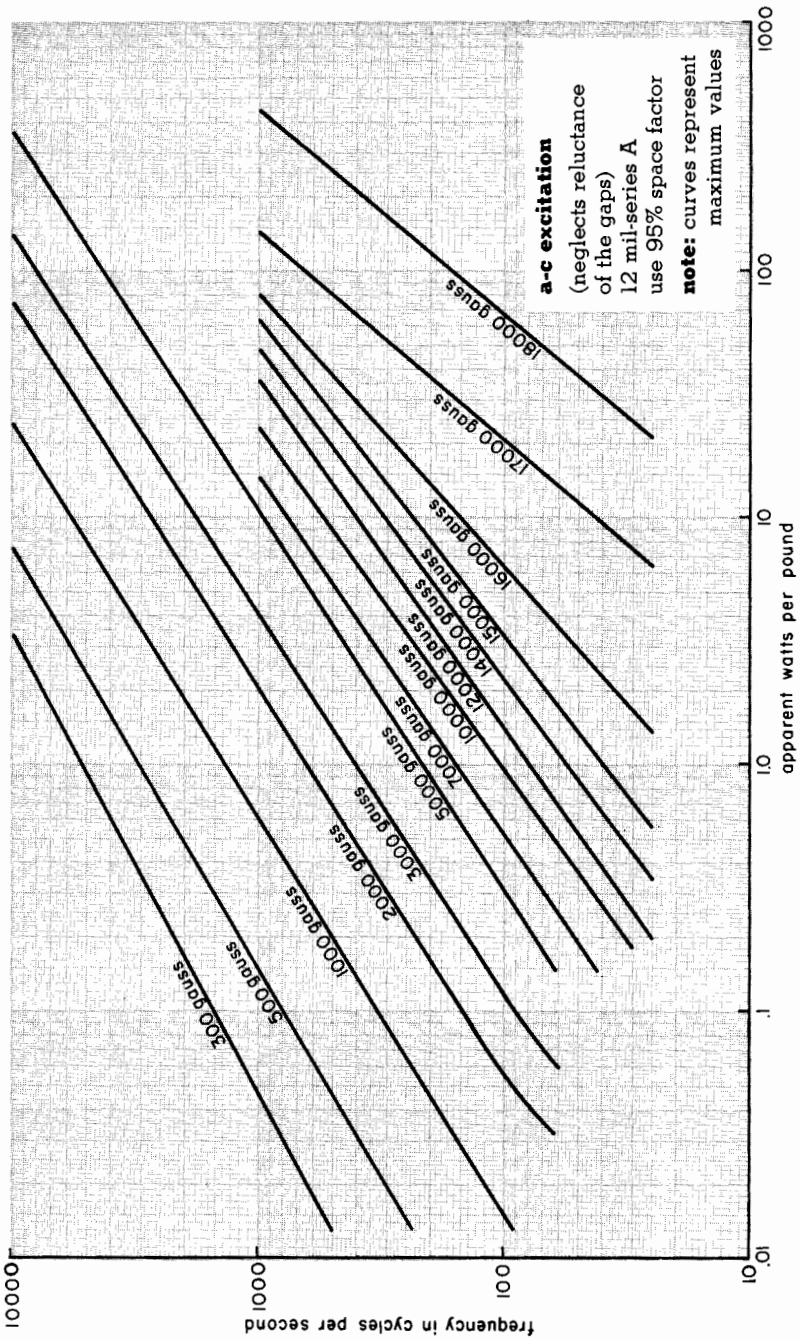

Figure 16 Incremental permeability • Single phase • 12 mil

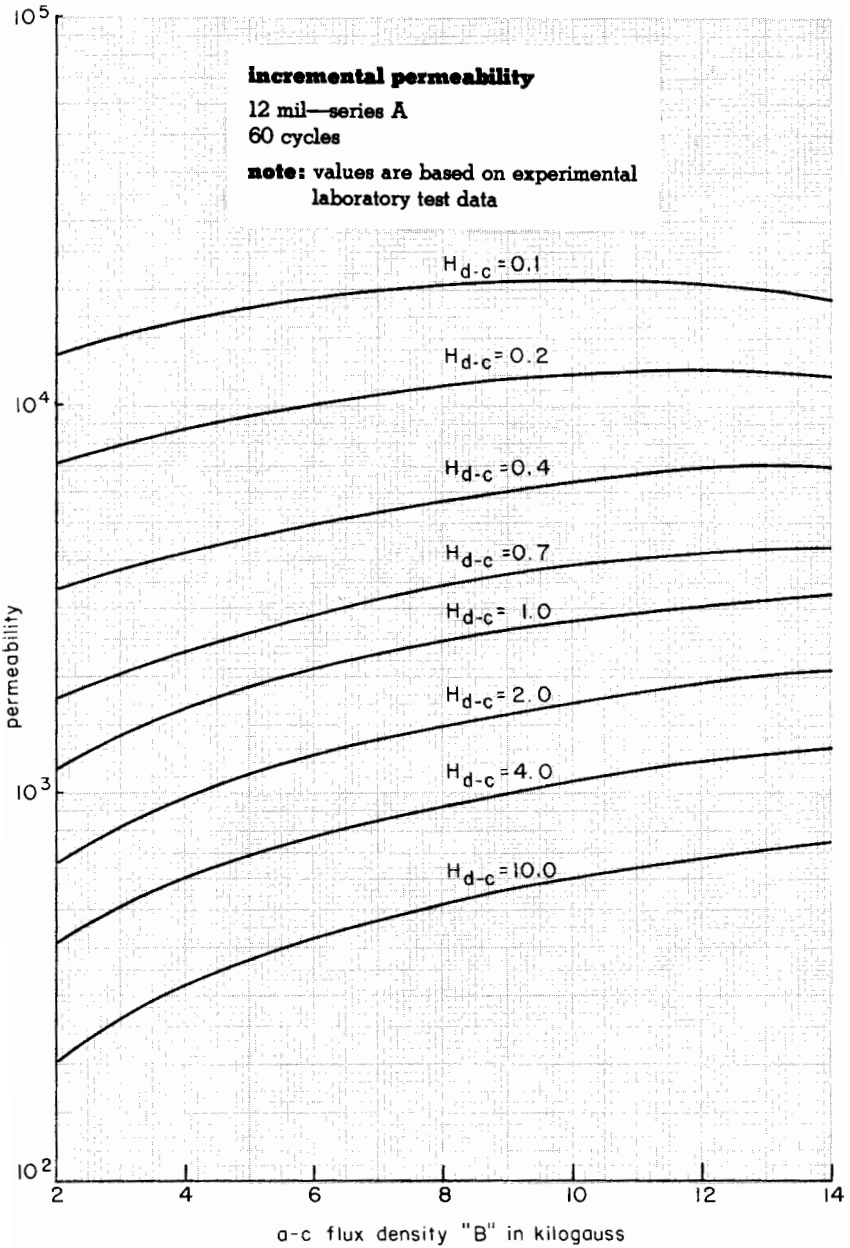

Figure 17 D-c magnetization curve • 12 mil • series A

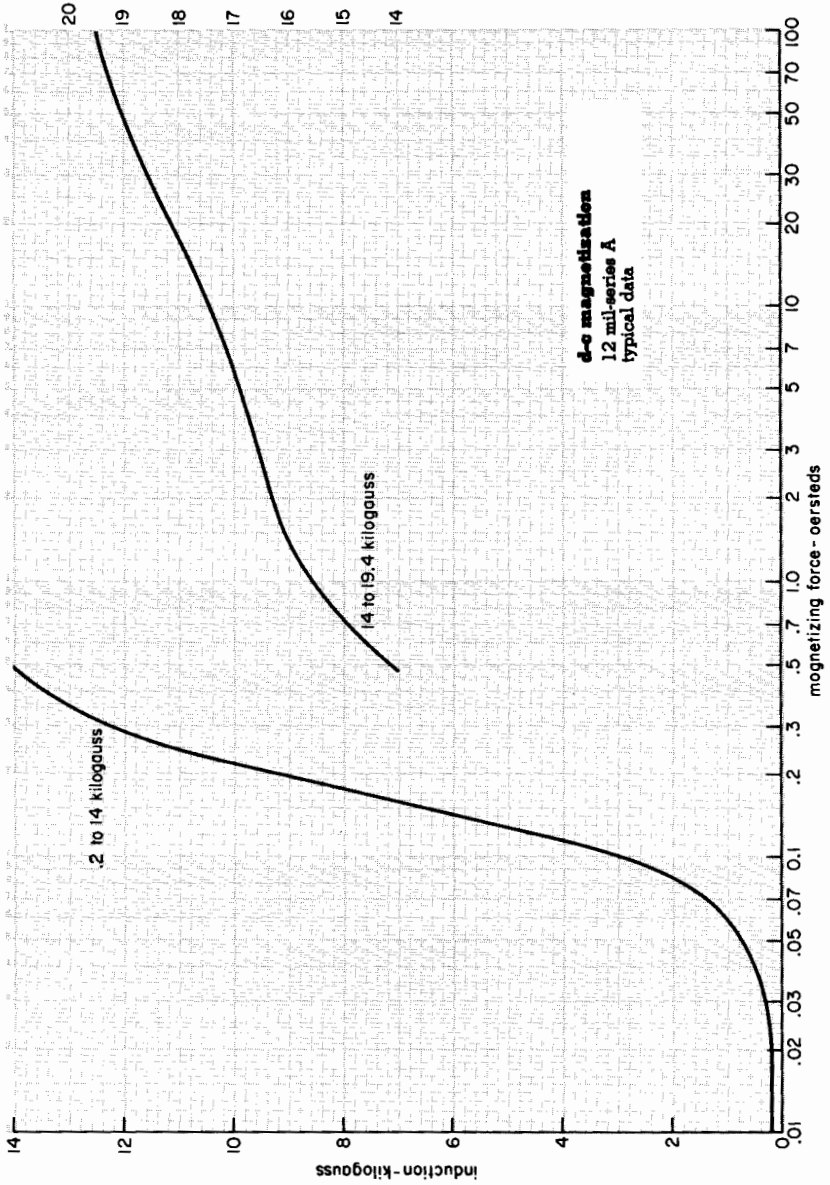

Figure 18 Core loss curve • 4 mil • series H

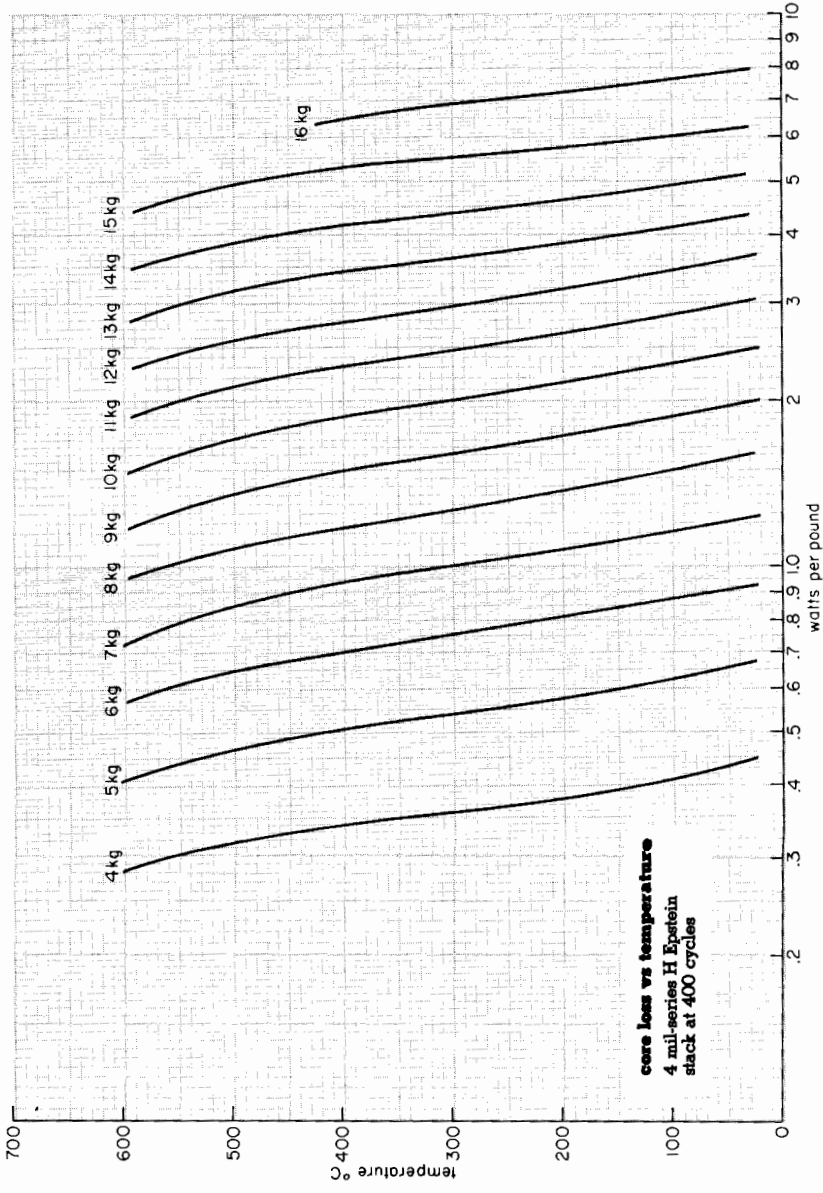

Figure 19 Watt per pound • series H

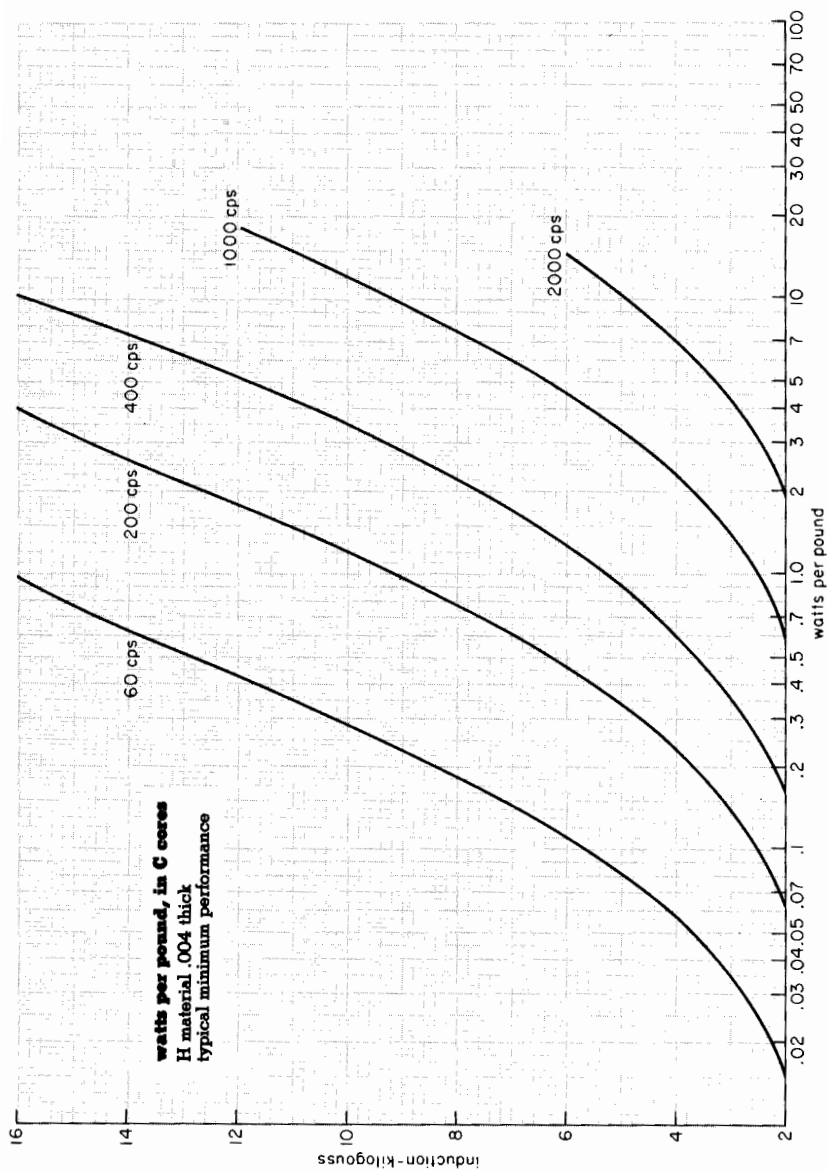

Figure 20 V-a per pound • series H

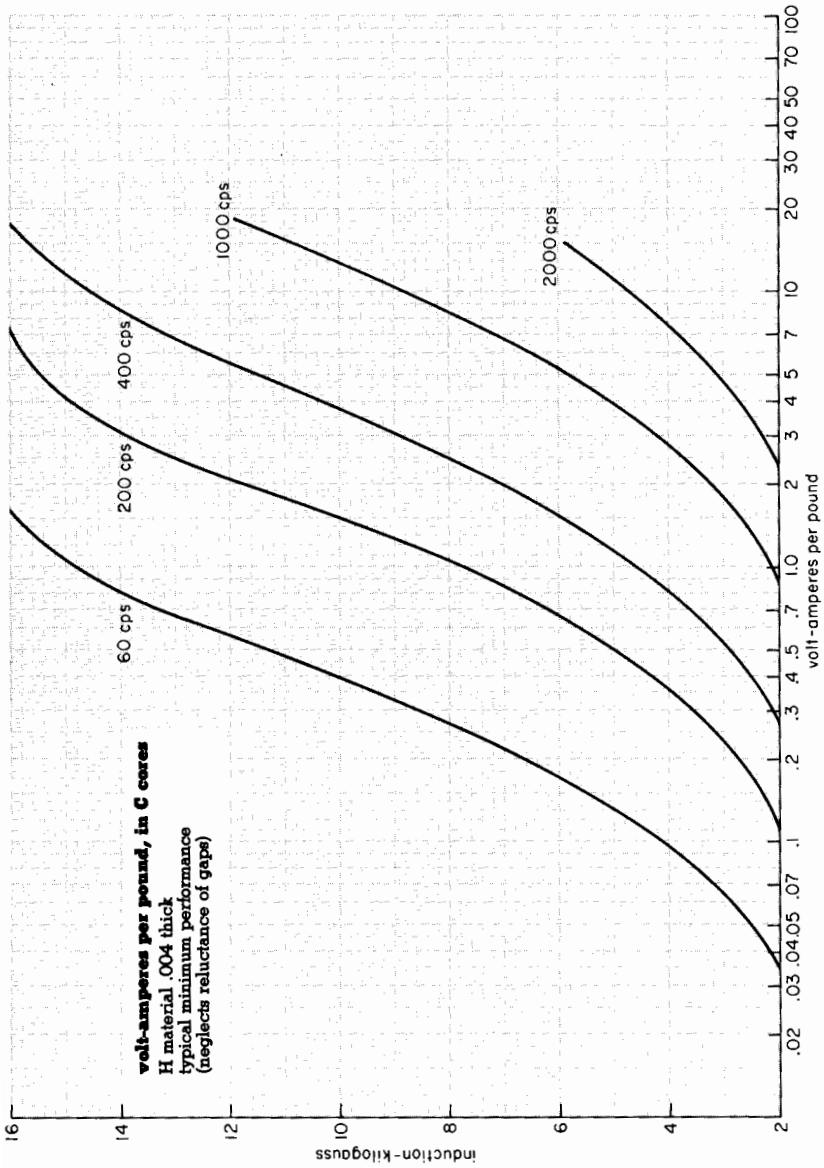
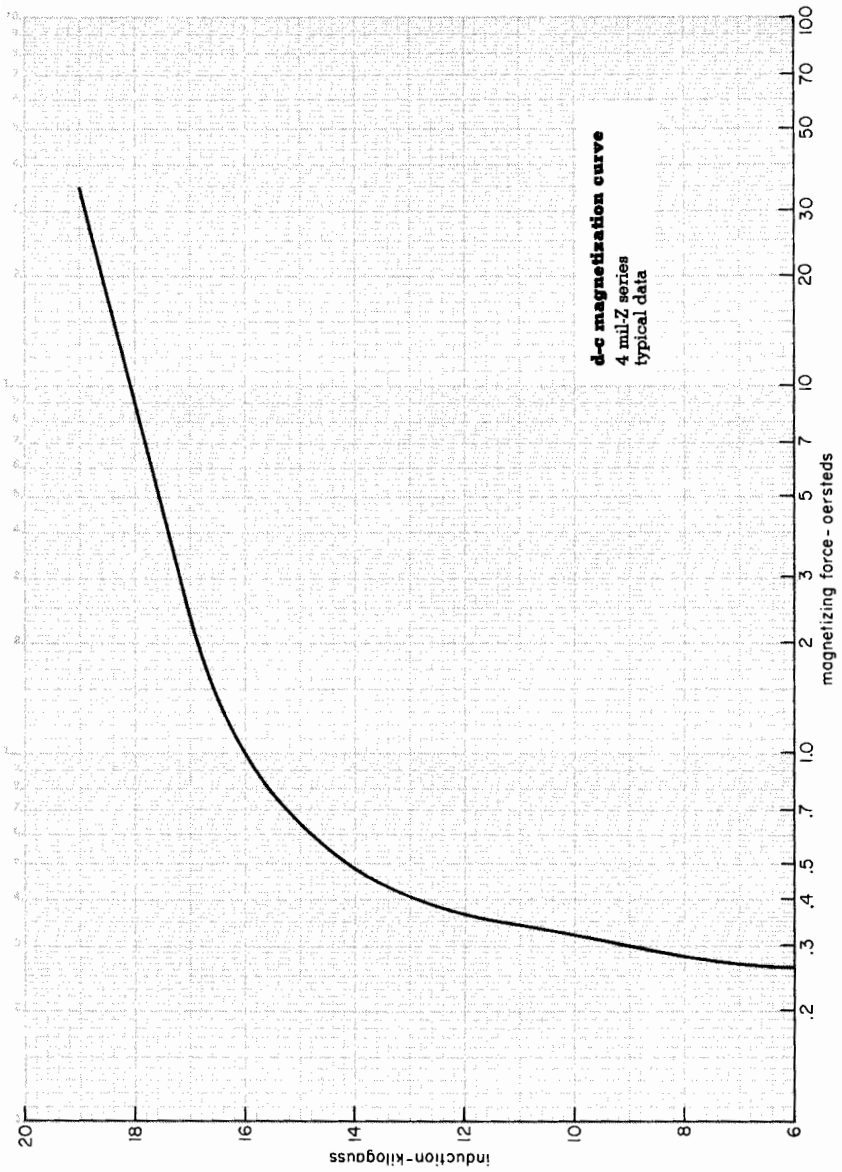

Figure 21 D-c magnetization • 4 mil • series H



April 15, 1965

Figure 22 Core loss and excitation curve • single phase • 4 mil

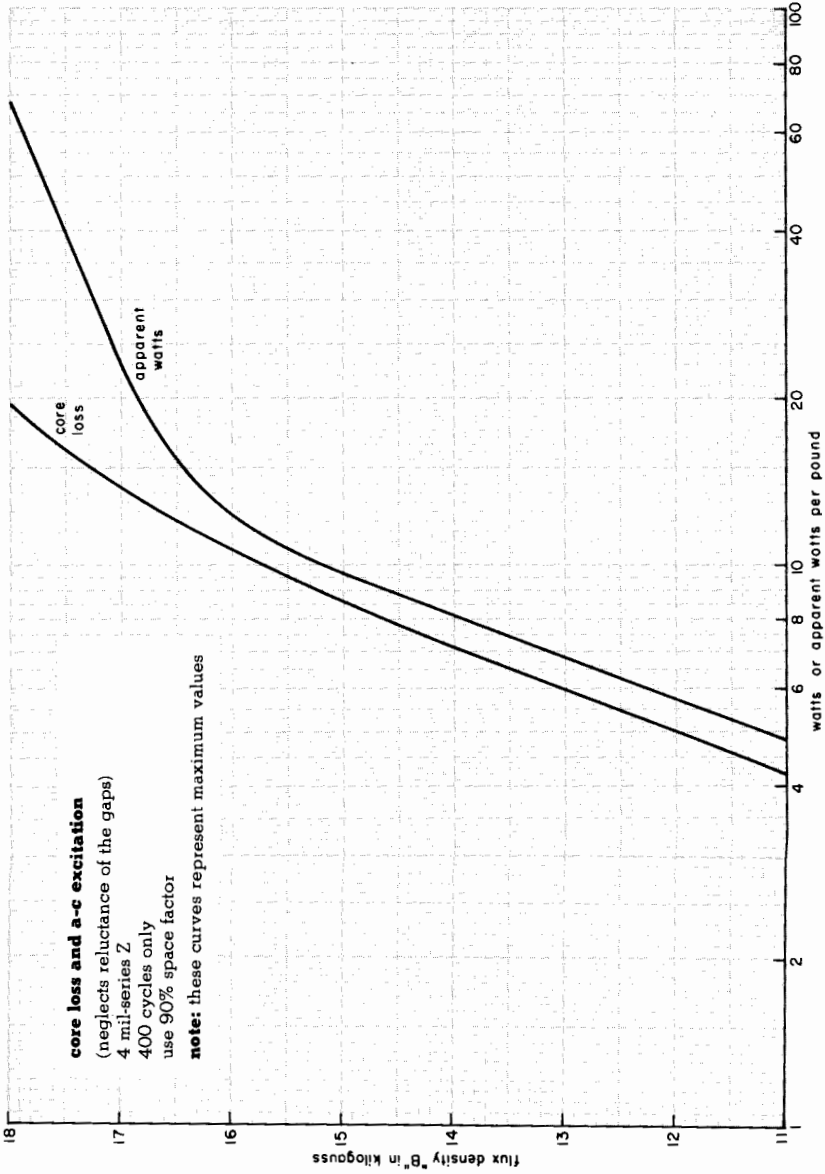



Figure 23 D-c magnetization • 4 mil • series Z

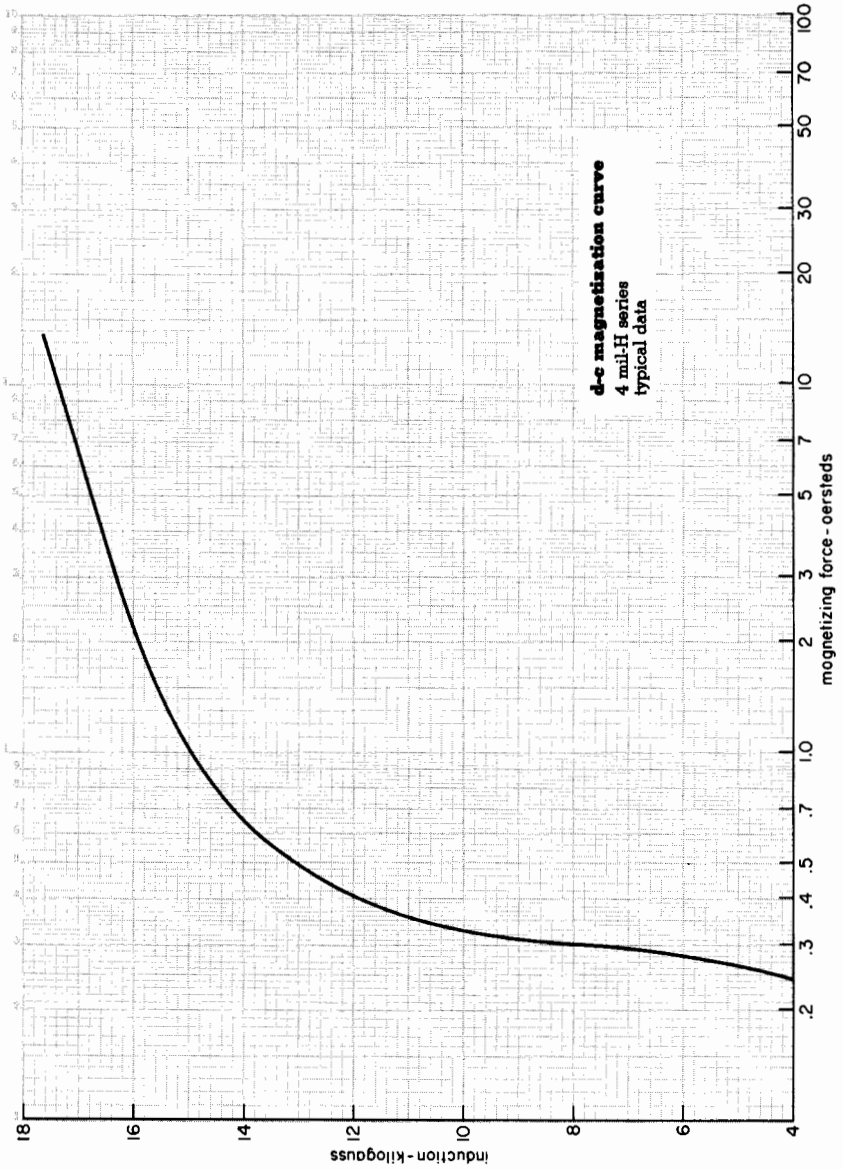

Figure 24 Incremental permeability • single phase • 4 mil

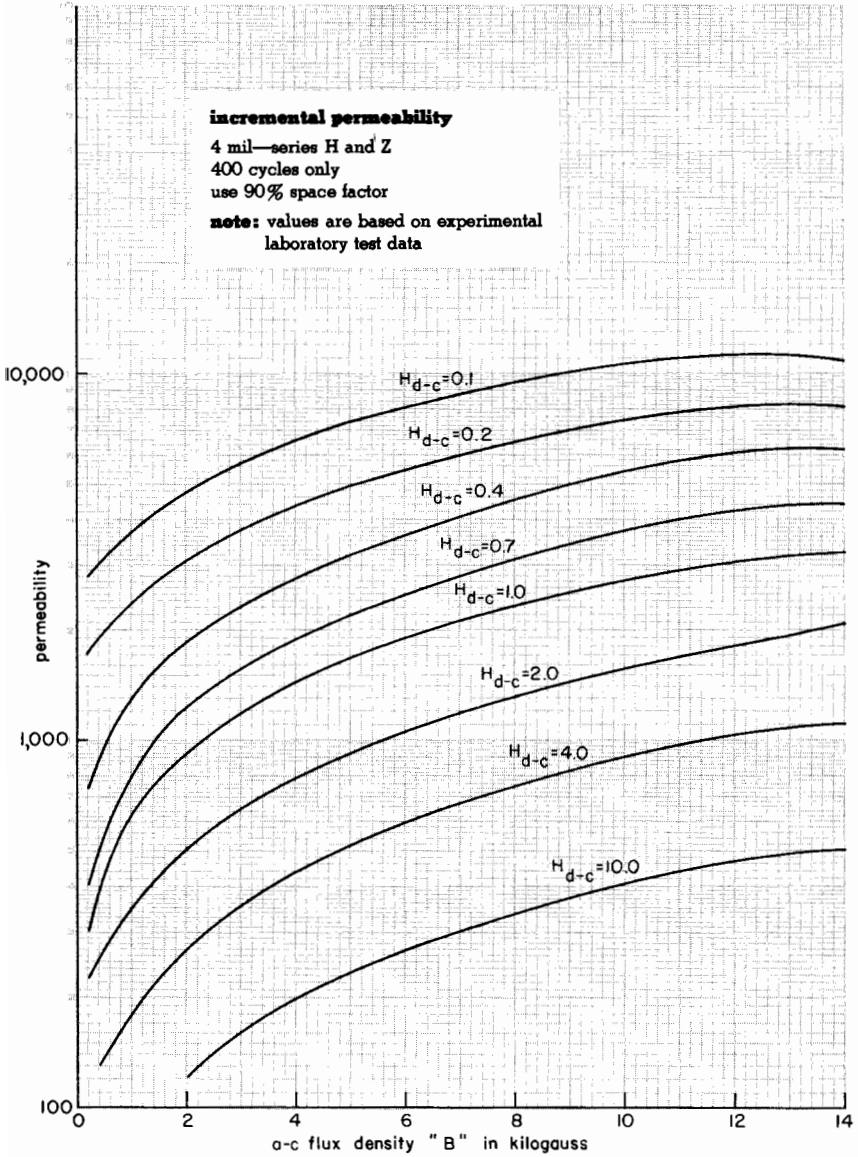

Figure 25 Core loss curve • single phase • 2 mil

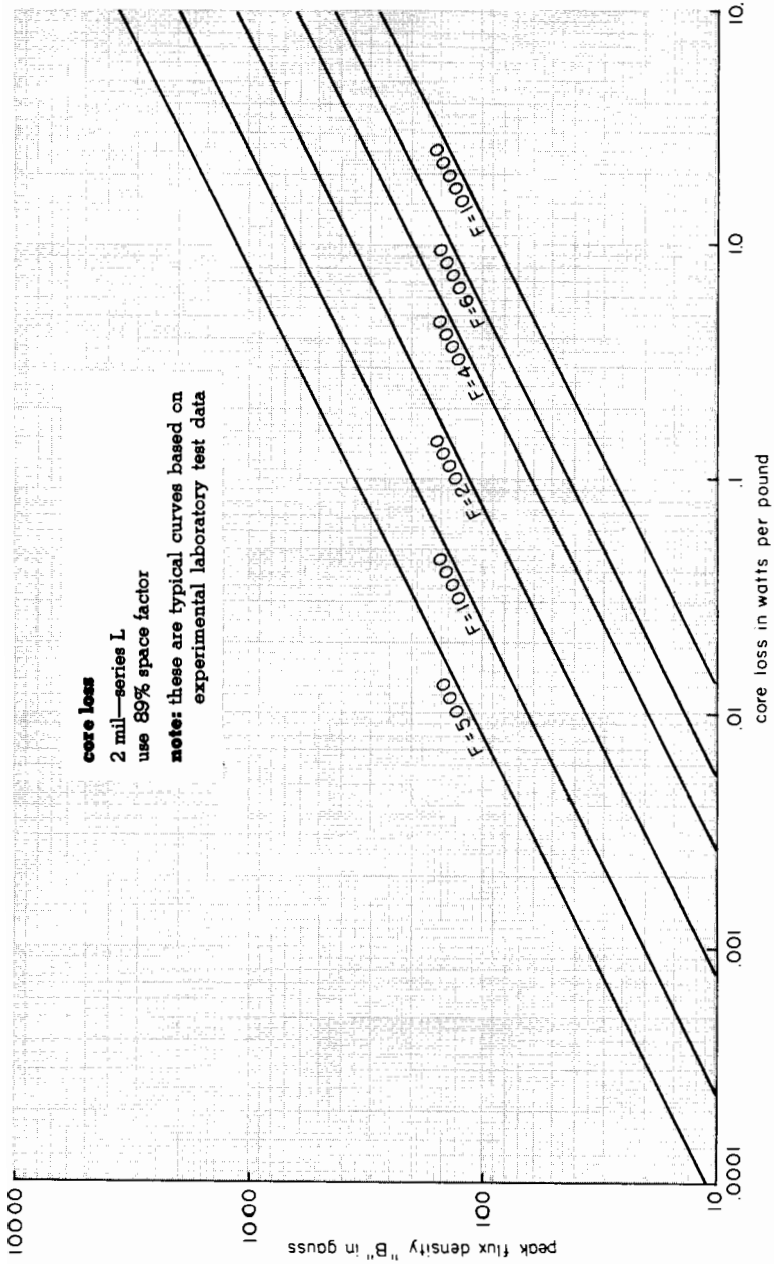

Figure 26 A-c excitation curve • single phase • 2 mil

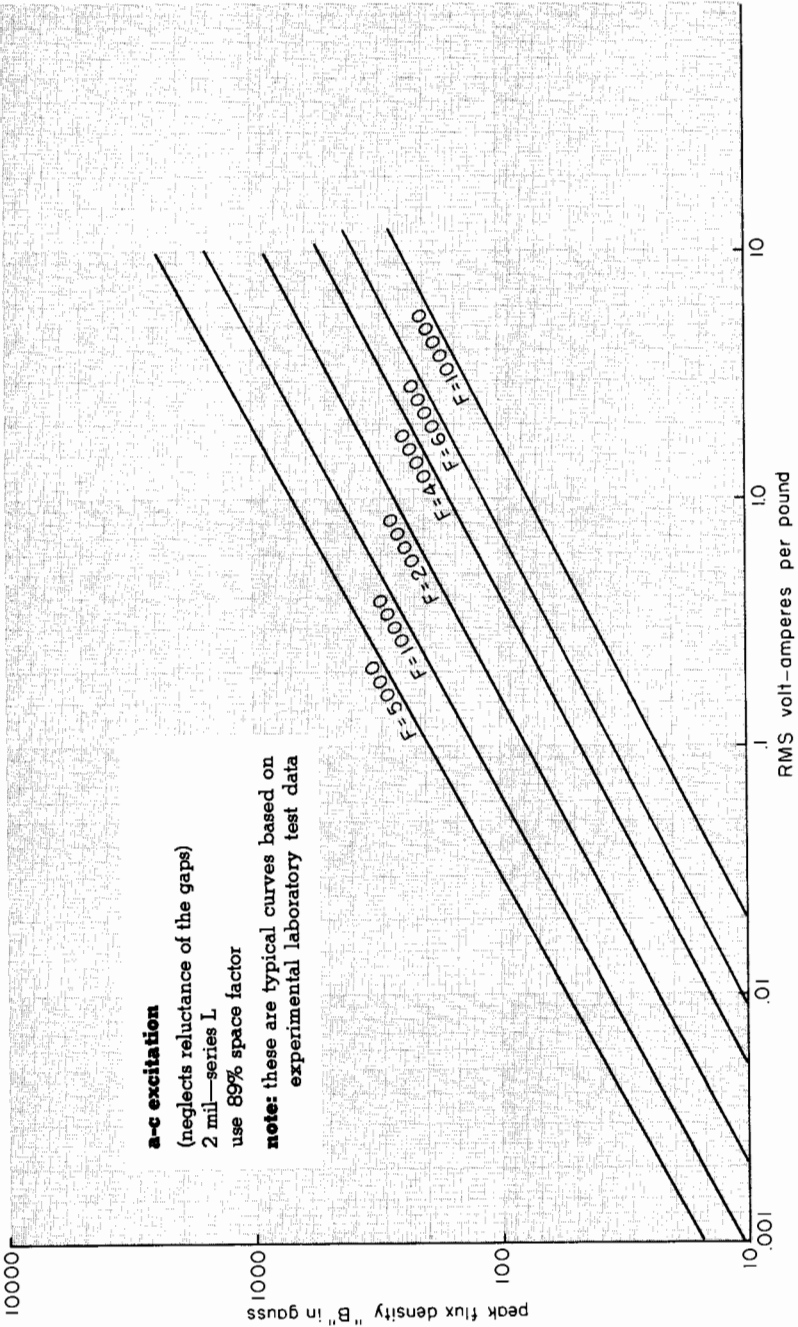

Figure 27 Pulsed excitation curve • single phase • 2 mil

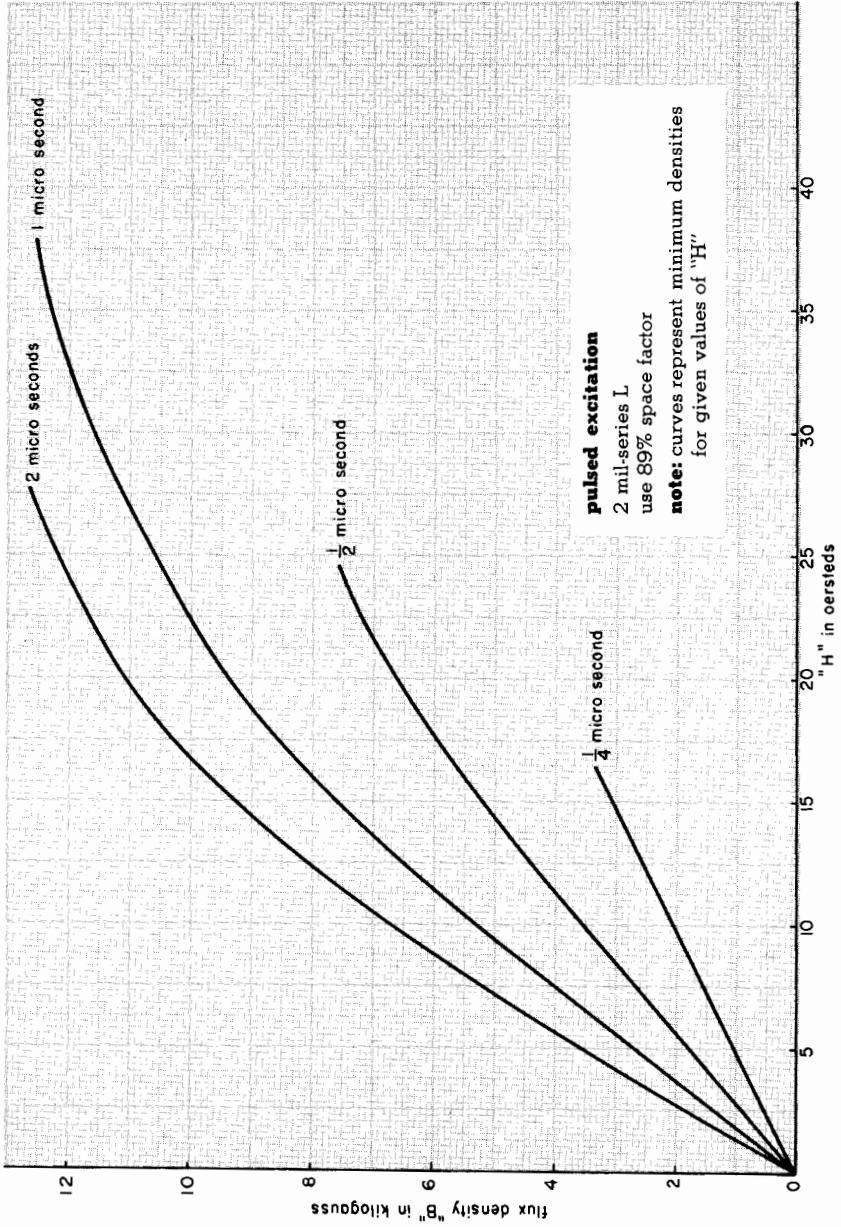

Figure 28 Pulsed core loss curve • single phase • 2 mil

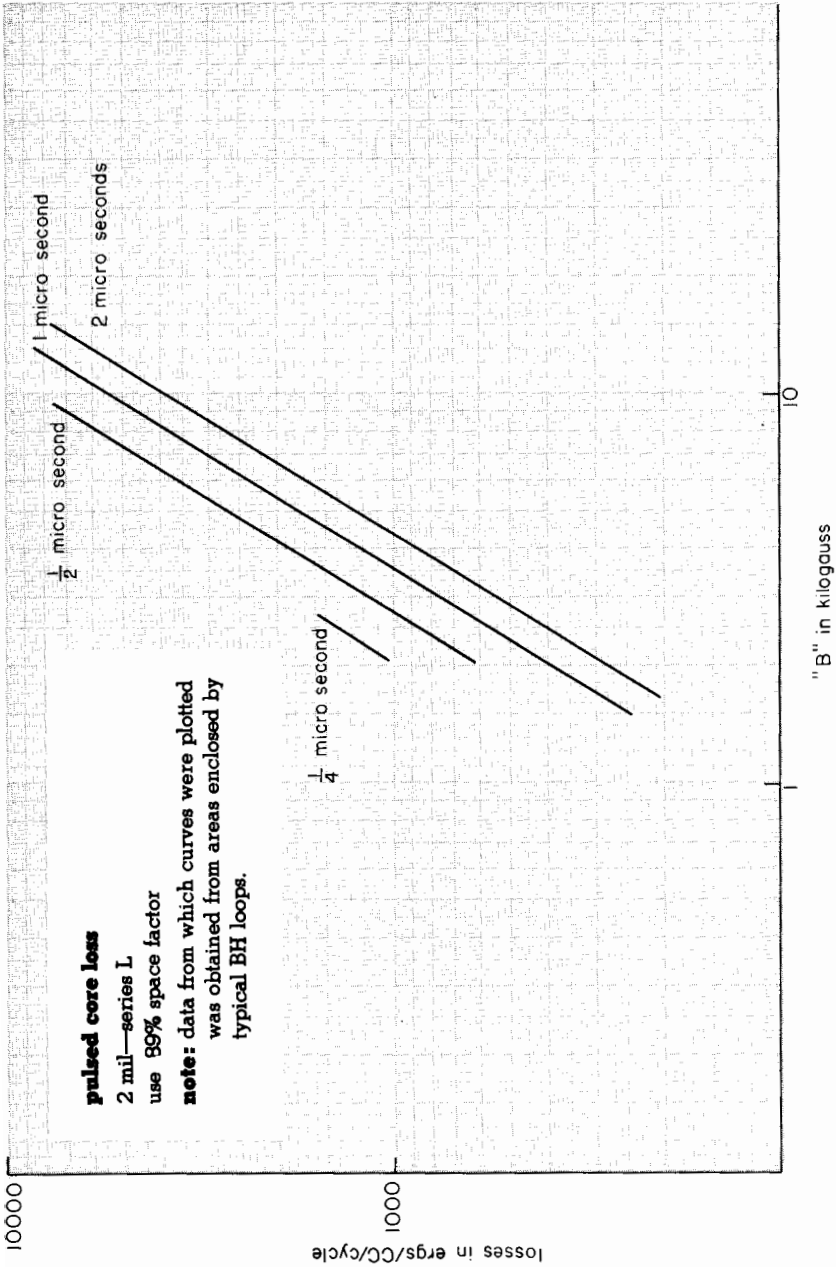

Figure 29 Incremental permeability • single phase • 1 and 2 mil

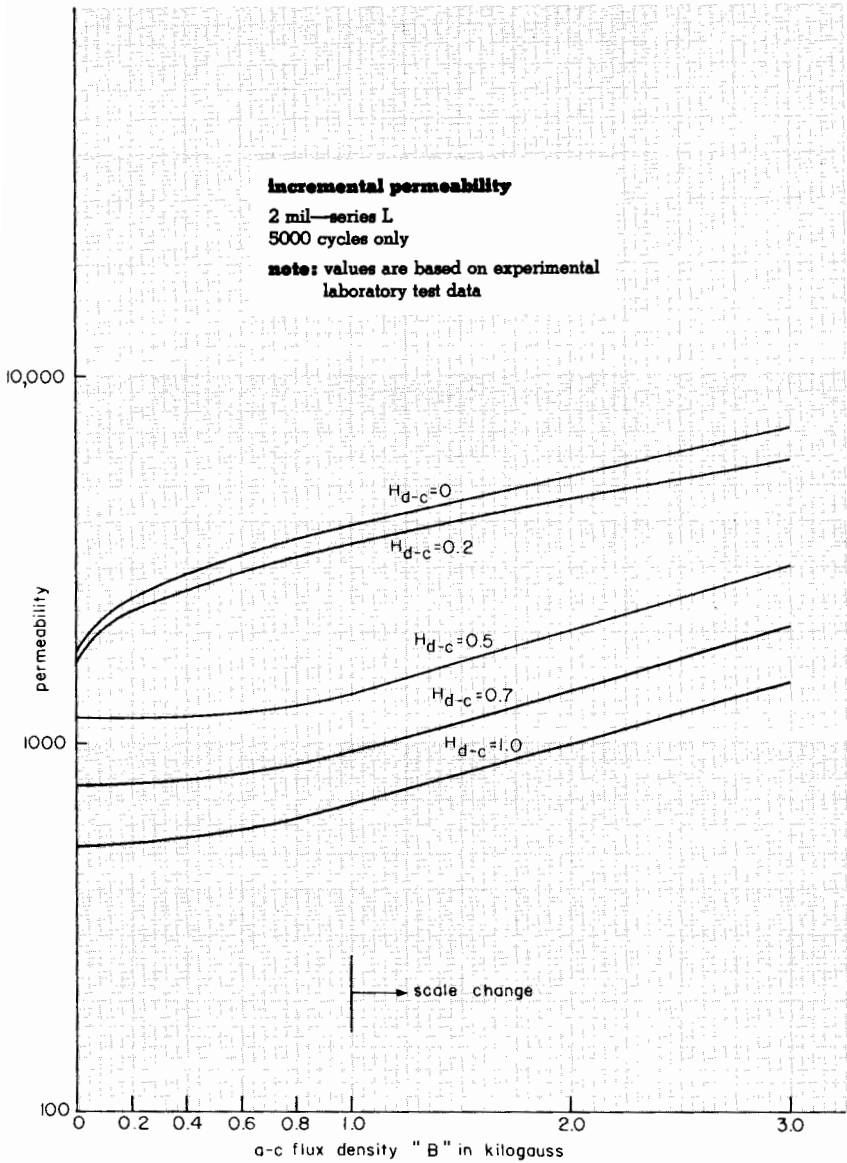
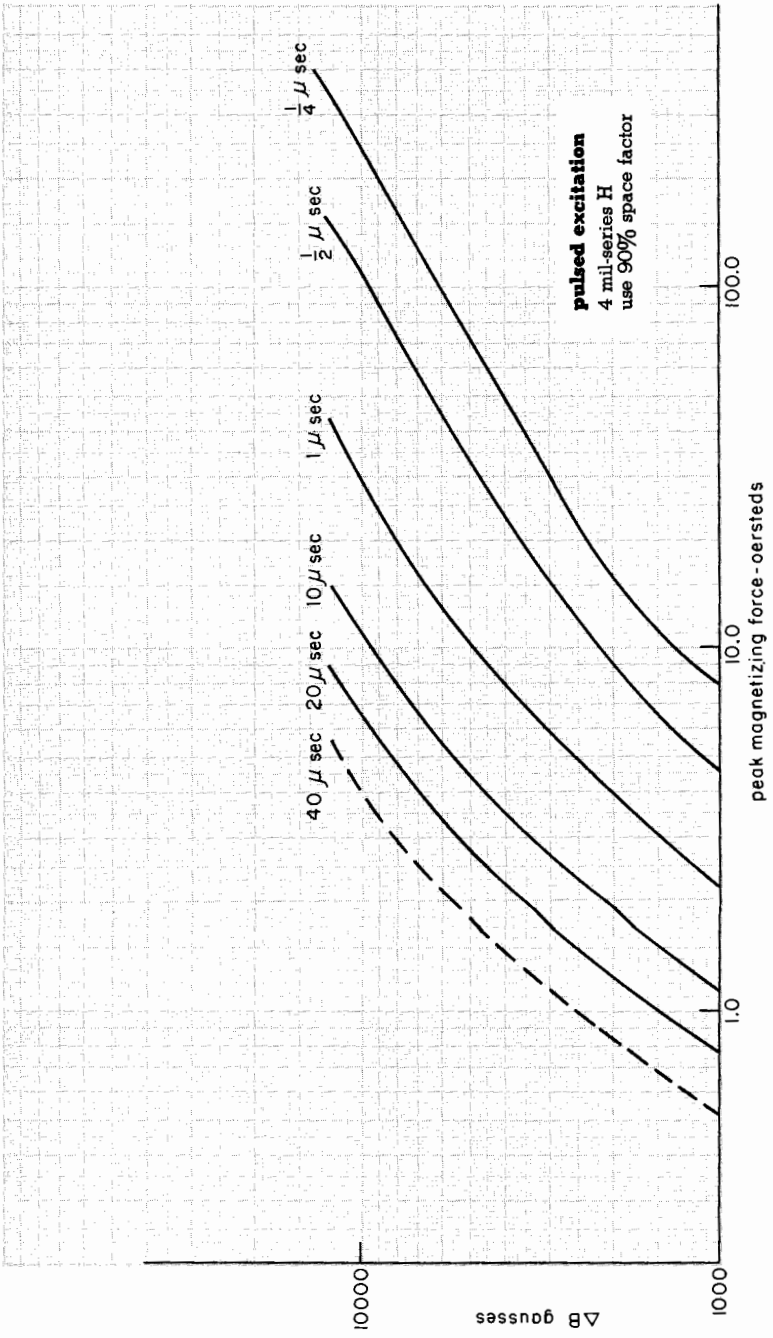

Figure 30 Pulsed excitation curve • 4 mil • Series H





## **MECHANICAL TOLERANCES**

The mechanical tolerances of ring, C and E cores are shown in technical data 46-760. For type C cores, these are as adopted by the Electronic Industries Association and specified in Standard RS-217.



## ASSEMBLY OF CORES WITH COILS

### Assembly of Small Cores

Place the coil over the bottom section/sections of the core carefully to avoid gouging the insulation of the coil tube. Although small cores usually do not require a joint compound treatment, joint surfaces should be cleaned with a dry paintbrush or dry compressed air before assembly.

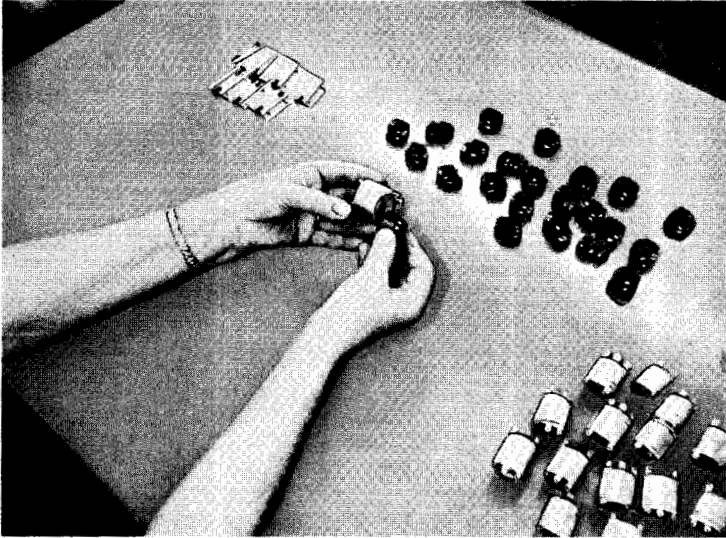

Figure 31 Core/coil assembly

### **POSITIONING THE BRACKET AND CORE**

Next, the mounting bracket is placed in position. The band is pulled around the bracket and under the core.

### **ASSEMBLY OF UPPER CORE SECTION ON BOTTOM SECTION**

The upper section is lined up with the catalog number marking on the core bottom section and is lowered into the coil with special care to insure that:

- the coil is not gouged
- no foreign material is carried into the joint.

For class F or H use, for 3 phase cores, or if noise is a problem, apply joint compound 1454 892 with an oil can (3-4 drops/sq. in.) to the bottom core half joint surfaces.

The upper section should be well-seated on the bottom section and in alignment with it.

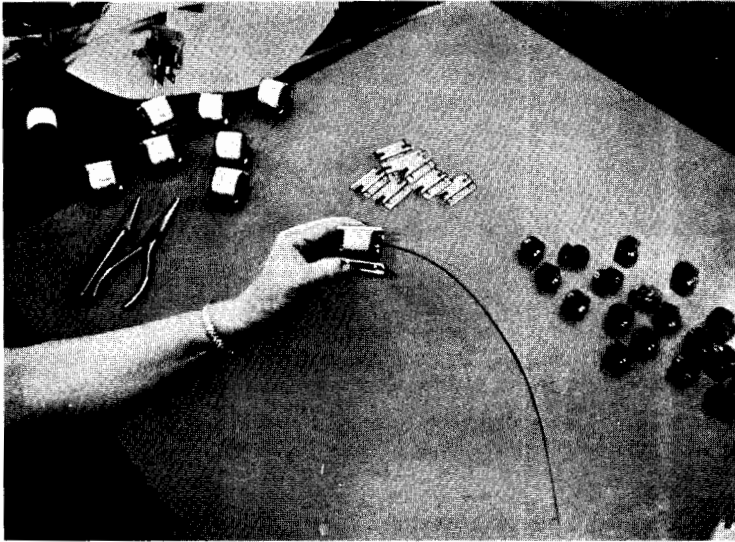

Figure 32 Bracket placed in position—band pulled around core and under bracket

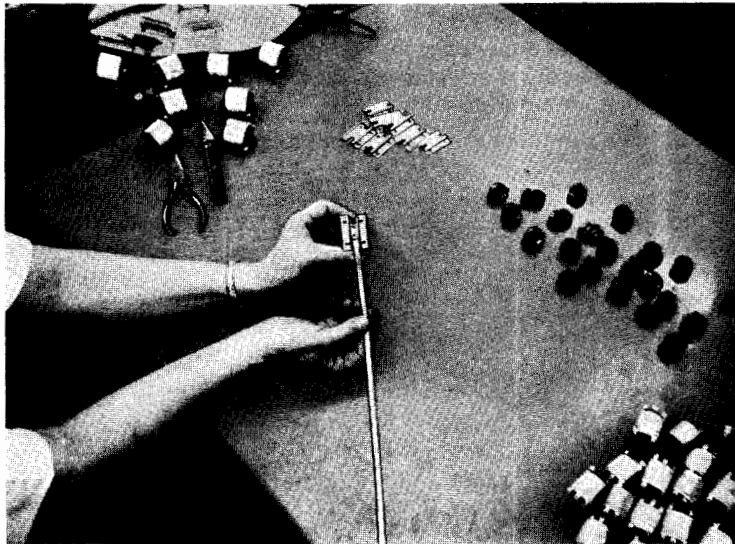

Figure 33 Seal on band—band pulled tight

### **BANDING OF SMALL CORES**

Table B (Page I-1) should next be consulted to determine the size and number of bands to be utilized, and the seal style number for the particular core to be banded. The band(s) are placed around the core and the seal slipped over the end of the band and the band is bent inward under the seal. The starting end should be long enough to extend around the corner of the core.

The free end of the band is inserted into the jaws of stretching tool style number 1263 732 and the band is pulled up snugly to the core.

The core sections are then aligned, and the bands located parallel to the edge of the core at all points.

### **BAND SEAL AND CUTOFF**

The band is now crimped, soldered or spot-welded to the seal with the banding tool in place. (In soldering operations, a minimum of rosin soldering fluid should be utilized. Solder consisting of 60% lead and 40% tin is recommended.)

After the seal is fastened, the banding tool is removed by pressing the release lever and excess banding is trimmed off by means of standard tin-snips.

### **WEDGES OR FILLERS**

If coil wedges or fillers are used between the core and the inside of the coil to provide uniform spacing or centering, they should be designed for only a moderately tight fit so that there will be no danger of preventing the core joint from closing.

### **MOUNTING BRACKETS OR (FRAMES)**

If the brackets are designed so that they extend around the edge of the core, insulation should be used so that laminations are not shorted together.

Also, the brackets should be so designed so that no force is transmitted to the core other than that developed by the band. High exciting current or high loss may be produced if these precautions are not observed.

note: Appendix A shows a series of mounting brackets that may be used for simple core-coil construction.

Lastly, the insulation between the core and the frame causes the core to "float" electrostatically. It is necessary, therefore, to ground the cores to the brackets through a metallic connection (usually a copper braid under the banding strap to the frame) to prevent static discharge.

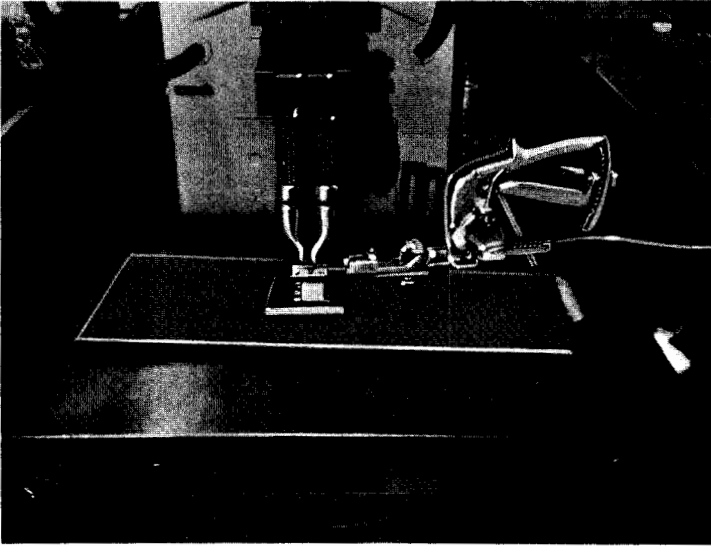

Figure 34 Band pulled tight with stretching tool—ready for spot welding

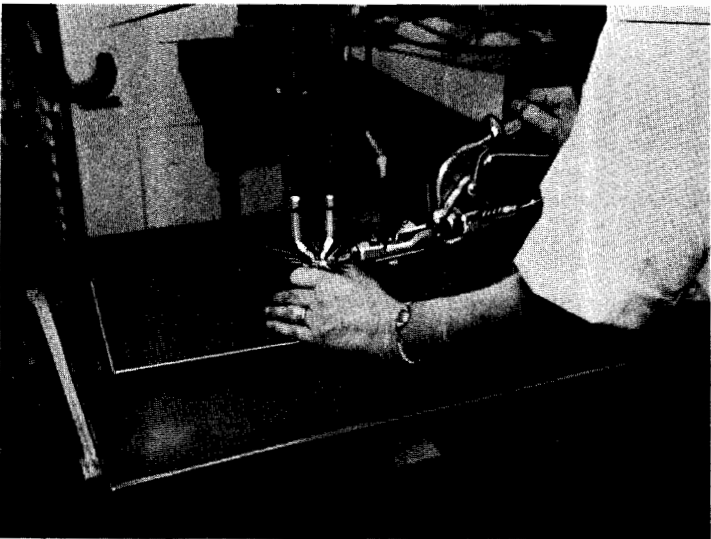

Figure 35 Spot welding—(note sparks)

### ASSEMBLY OF LARGE CORES (11 LBS AND OVER)

When assembling large type C cores, the same general procedures are followed as for small cores except that a larger band is used with  $\frac{3}{4}$  inch, crimp-type seals.

Strip all protective material from the cores and remove any traces of adhesive residue with a clean rag dampened with acetone. If necessary, buff the joint surfaces lightly with a motor driven soft steel wire brush. Maintain brush rotation in the plane of the laminations.

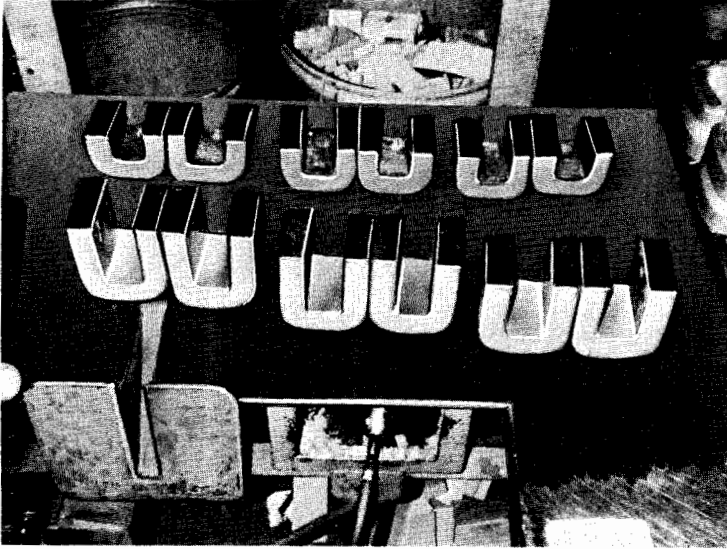

Figure 36 Cores laid out for assembly—bottom yoke insulation in place

Assemble the bottom core halves, coils, and any inter-core insulation. Check to be sure no foreign material is on the joint surfaces. Apply compound style number 1454 892 with an oil can (3-4 drops/sq. in.) to the bottom core half joint surfaces. Then lower the core caps into place, along with the top intercore spacers (when used). **BE VERY CAREFUL NOT TO SCRAPE ANY FOREIGN MATERIAL INTO THE GAP DURING THIS OPERATION.**



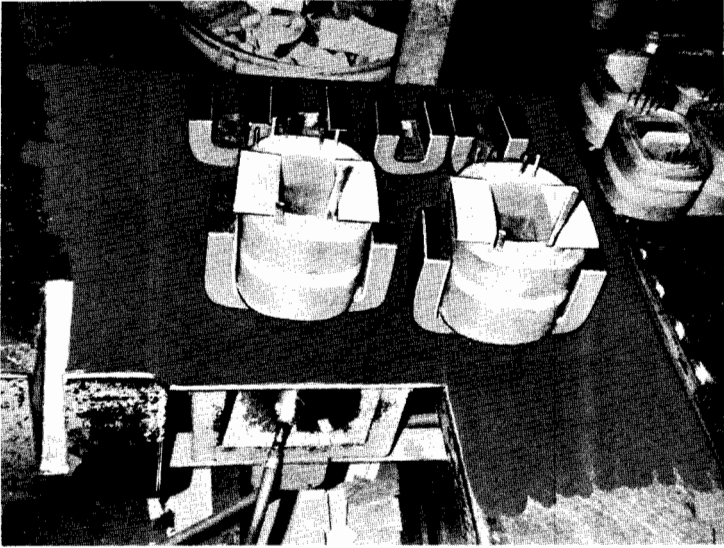

Figure 37 Coils lowered into place—top yoke insulation shown in position

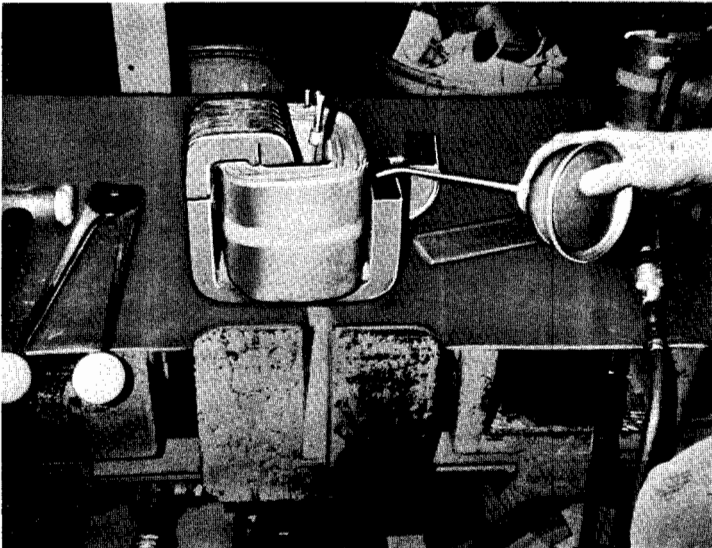

Figure 38 Applying joint compound

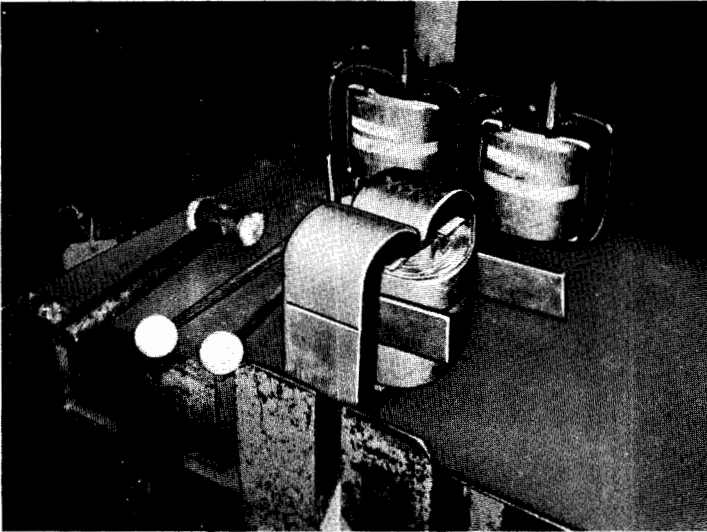

Figure 39 Core section in position—(wedges are to align core halves and will be withdrawn later)

Oscillate the halves to spread the compound and reduce joint thickness to a minimum; and band per next paragraph within five minutes after compound application. In most cases, this will necessitate assembling and banding one core at a time.

Place the required number of bands around each core, exercising care that they do not snag any laminations at the joint. Slide a seal on each band, with the pressed rib inside. Bend the lower end of the band back under the seal so this end reaches to at least 45° point of the core's corner radius when the seal is in position.

Set the air pressure for the Acme BID6 banding tool to the value marked on the calibration tag for the tension desired with the tool running idle. Slip the tool on the band and gradually pull up the latter by intermittently operating the air valve while tapping the core parts. Meanwhile, adjust the seal and band positions to secure proper register. Then pull the band to its rated tension by stalling the tool. The air valve must be left on while crimping the seal.

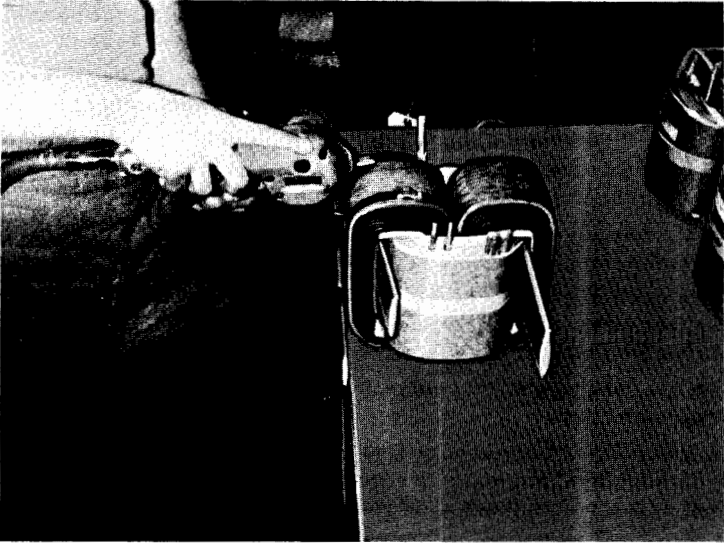

Figure 40 Application of bands—Acme B106 stretching tool in use

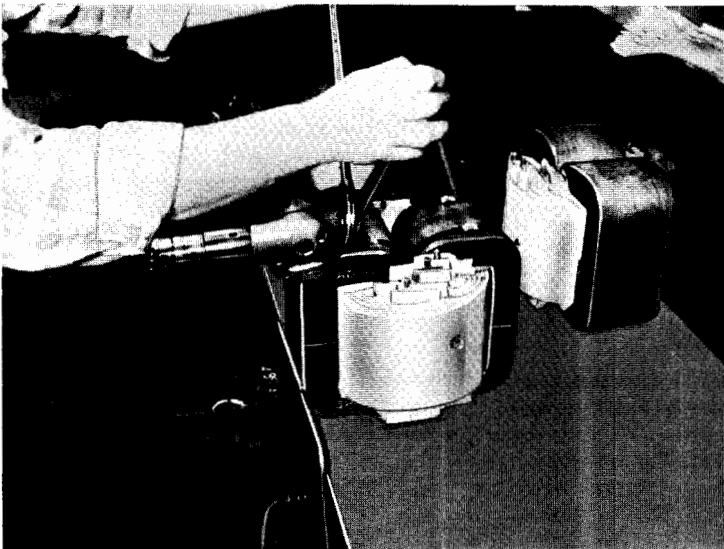

Figure 41 Seal being crimped

## assembly of cores with coils H-10

The loop end of the seal may be tapped with a mallet to flatten the band into good conformity with the seal. This arrests a tendency for the band to tear into the seal.

Keep the seals away from the core joint; and alternate them to prevent mutual interference. Adjacent bands should be at least  $\frac{1}{4}$ " apart so the banding and crimping tools will not bear on any previously installed band.

Place the first band near the center of the core. Then tighten additional bands in order from this first band outward to the core edges.

Position the crimping tool squarely on the seal and operate it so minimum band lift occurs. Improper operation will result in a loose band.

Cut two crimps in each seal. The first should be nearer the nose of the banding tool. Tool wear and pressure will affect the depth of crimp; so periodic checks should be made to be sure the crimp marks cut through the seal and into the band.

Break off the band by elevating the rear of the banding tool while holding its nose firmly against the core.

The BID6 tool must be operated on clean, lubricated air. This may be provided by installing a filter, oiler, and regulator at each work station. Adjust the oiler so a slight deposit of oil is maintained around the tool vents. ASE-10 motor oil should be used.

Grease the rear bearing fitting once a week with #2 AGMA EP gear oil (Socony Gargoyle Compound AA or equivalent). Clean the rotary dog and pusher parts occasionally; and calibrate the tools on a regular basis ( $\pm 10\%$ ).

The assembly should then be baked at 125-135°C and held at this temperature for three hours after reaching temperature.

If it becomes necessary to disassemble a core/coil assembly that contains baked joint compound, preferred technique is to heat the assembly to a temperature of 125°-135°C. Dismantle while the assembly is still hot, to minimize possible core damage.

If shop facilities are such that reheating is impractical, break the core joints by striking the core sides a sharp blow with a rawhide mallet. Clean all compound from the joint surfaces by wire brushing as in Section 1; and wipe these surfaces clean with an acetone dampened rag.

The following table may be used as a guide in determining the proper number of bands for a given core.

**TABLE I**

core dimensions (cross section in square inches—one leg)	band size	number	tension (pounds)
3.0 to 4.25	$\frac{3}{4}$ " x .035"	1	900
4.25 to 6.0	$\frac{3}{4}$ " x .023"	2	600
6.0 to 9.0	$\frac{3}{4}$ " x .023"	3	600
9.0 to 13.5	$\frac{3}{4}$ " x .035"	3	900
13.5 to 18.0	$\frac{3}{4}$ " x .035"	4	900

This table is based upon a recommended core pressure of 200-300 psi. For larger cores, add bands as necessary to maintain this range.

Certain cores of relatively narrow strip width may not accommodate sufficient bands to develop 200 psi. In such cases, the minimum pressure may be shaded to 150 psi. This should be regarded as an absolute minimum.

Cores with an extremely low D/E ratio may require special clamping arrangements.

**example:**

A core of  $7\frac{1}{2}$ " strip width and 5" buildup is to be banded.

$$7\frac{1}{2} \times 5 = 37\frac{1}{2} \text{ in}^2 \times 200 \text{ psi} = 7500 \text{ pounds}$$

$$150 \text{ psi} = 5600 \text{ pounds}$$

Normally, this core would require 9 bands ( $\frac{3}{4}$ " x .035") pulled to 900 pounds each.

$$9 \times 900 = 8100 \text{ pounds}$$

Common practice is to allow at least  $\frac{1}{4}$ " spacing between bands; and the application of 9 bands is not considered feasible.

Seven bands will permit the required spacing; and their cumulative tension ( $7 \times 900 = 6300$  pounds) is above the absolute minimum. Hence, seven bands can be used with this core for all but the most critical applications.



## CORE BANDING TECHNIQUE

### Table II. Determining the Size and Number of Bands

(Select band, seal and tension according to core size in this table)

core dimensions (1 leg)		banding strap		seal		banding tool	
cross section area in sq. in. (D x E)	width of strip in core-inches	size in inches	no. used	style number	size in inches	style number	tension in pounds
.188 or less	any	$\frac{3}{16}$ x .006 ⊕	1	1304 065	$\frac{3}{16}$ x $\frac{1}{4}$	1263 732	37.5
.188 to .375	$\frac{3}{8}$ or larger	$\frac{3}{8}$ x .006 ⊕	1	1294 363	$\frac{3}{8}$ x $\frac{3}{8}$	1263 732	75
.375 to .75	$\frac{3}{8}$ to $1\frac{1}{2}$	$\frac{3}{8}$ x .012 ⊕	1	1294 363	$\frac{3}{8}$ x $\frac{3}{8}$	1263 732	150
.....	1 $\frac{1}{2}$ or larger	$\frac{3}{8}$ x .006 ⊕	2	1294 363	$\frac{3}{8}$ x $\frac{3}{8}$	1263 732	75
.75 to 1.5	$\frac{1}{2}$ to $1\frac{1}{8}$	$\frac{3}{8}$ x .012 ⊕	1	1294 363	$\frac{3}{8}$ x $\frac{3}{8}$	1263 732	150
.....	1 $\frac{1}{4}$ or larger	$\frac{3}{8}$ x .012 ⊕	2	1294 363	$\frac{3}{8}$ x $\frac{3}{8}$	1263 732	150
1.5 to 3.0	$\frac{3}{4}$ or larger	$\frac{3}{4}$ x .023 ⊕	1	1293 783	$\frac{7}{8}$ x $1\frac{1}{8}$	Acme ⊕	600
3.0 to 4.25	$\frac{3}{4}$ or larger	$\frac{3}{4}$ x .035 ⊕	1	1293 783	$\frac{7}{8}$ x $1\frac{1}{8}$	Acme	900
4.25 to 6.0	2 or larger	$\frac{3}{4}$ x .023 ⊕	2	1293 783	$\frac{7}{8}$ x $1\frac{1}{8}$	Acme	600
6.0 to 9.0	$3\frac{1}{4}$ or larger	$\frac{3}{4}$ x .023 ⊕	3	1293 783	$\frac{7}{8}$ x $1\frac{1}{8}$	Acme	600
9.0 to 13.5	$3\frac{1}{4}$ or larger	$\frac{3}{4}$ x .035 ⊕	3	1293 783	$\frac{7}{8}$ x $1\frac{1}{8}$	Acme	900

joint compound—style number 1454 892 (1 quart)

- ⓐ Style number 1629 485
- ⓑ Style number 1629 486
- ⓒ Style number 1629 192
- ⓓ Style number 1629 191
- ⓔ Style number 1629 190
- ⓕ Air operated banding tool model B1D6 for  $\frac{3}{4}$ " strap may be obtained from:

Acme Steel Products  
2840 Archer Ave.,  
Chicago 8, Illinois

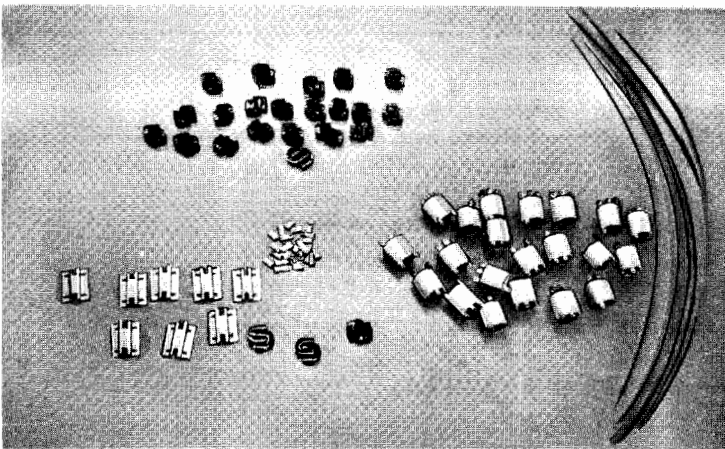

Figure 42 Cores, seals, mounting brackets, coils and bands laid out for assembly

## Banding Tool (Style Number 1263 732)

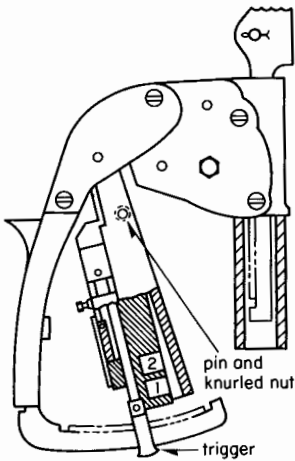

Figure 43 Banding tool, 150 pounds pressure used for smaller cores

The band stretching tool is shipped adjusted for 150 pounds of pressure. In operation, the nose of the tool is placed against the band seal, with the band running between the fixed and hinged portions of the nose and on back between the small platform and the dog on the side of the tool toward the reel. The handle is squeezed upward and allowed to drop. When the pre-set tool pressure is reached, the latch is tripped, preventing further tightening of the band. Specific pressures required for banding are as follows:

pressure	hole # 1	hole # 2
37½ pounds	bright spring	black spring
75 pounds	bright spring on foot	black spring on foot
150 pounds	bright spring on foot	bright spring on foot

To change tripping pressure, all that is necessary is to:

- remove knurled nut from pin through the handle
- withdraw pin
- open handle and arrange the springs in accordance with the above outline.

Check calibration of banding tools frequently.



## APPENDIX A

### Mounting Brackets

Spot-Weld Cradle and Base Together  
(with E = number of spots)

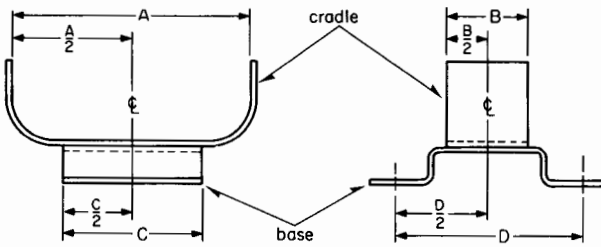

Figure 44

group	dimensions in inches				E (no. of spots)	core reference
	A	B	C	D		
1	$1\frac{1}{16}$	$\frac{1}{2}$	$1\frac{5}{16}$	$1\frac{1}{4}$	2	Z-98
2	$1\frac{3}{8}$	$\frac{5}{8}$	$1\frac{5}{16}$	$1\frac{7}{16}$	2	Z-99

Spot-Weld Cradle and Base Together  
(with E = number of spots)

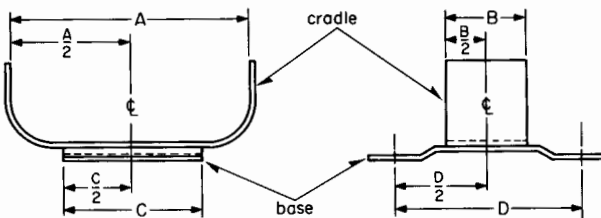

Figure 45

group	dimensions in inches				E (no. of spots)	core reference
	A	B	C	D		
15	$1\frac{1}{16}$	$\frac{1}{2}$	$1\frac{5}{16}$	$1\frac{1}{4}$	2	Z-98
16	$1\frac{3}{8}$	$\frac{5}{8}$	$1\frac{5}{16}$	$1\frac{7}{16}$	2	Z-99

Spot-Weld Cradle and Base Together  
(with E = number of spots)

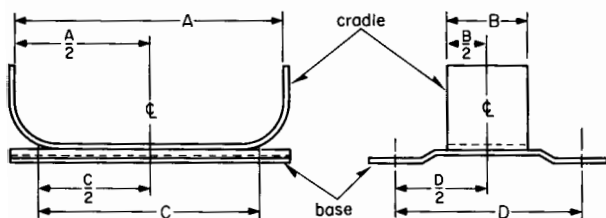

Figure 46

group	dimensions in inches				E (no. of spots)	core reference
	A	B	C	D		
3	$1\frac{3}{16}$	$\frac{5}{8}$	$1\frac{11}{16}$	$1\frac{7}{16}$	2	Z-100
4	$2\frac{3}{8}$	$\frac{3}{4}$	$2\frac{1}{8}$	$1\frac{3}{4}$	2	Z-101
5	$2\frac{1}{2}$	$\frac{3}{4}$	$2\frac{1}{8}$	$1\frac{3}{4}$	2	Z-102
6	$2\frac{9}{16}$	$\frac{7}{8}$	$2\frac{19}{64}$	$2\frac{55}{64}$	2	Z-103
7	$2\frac{13}{16}$	$\frac{7}{8}$	$2\frac{5}{8}$	$2\frac{1}{8}$	4	Z-104
8	$2\frac{15}{16}$	1	$2\frac{5}{8}$	$2\frac{1}{8}$	4	Z-105
9	$3\frac{5}{8}$	1	3	$2\frac{7}{16}$	5	Z-106
10	$3\frac{7}{16}$	$1\frac{1}{8}$	3	$2\frac{7}{16}$	5	Z-107
11	$4\frac{1}{16}$	$1\frac{1}{4}$	$3\frac{5}{16}$	$2\frac{11}{16}$	5	Z-108
12	$4\frac{13}{16}$	$1\frac{1}{4}$	$3\frac{11}{16}$	3	5	H-499
13	$4\frac{1}{16}$	$1\frac{1}{2}$	3	$2\frac{7}{16}$	5	H-500
14	$5\frac{1}{16}$	$1\frac{1}{2}$	$3\frac{11}{16}$	3	5	H-501

Spot-Weld Cradle and Base Together  
(with E = number of spots)

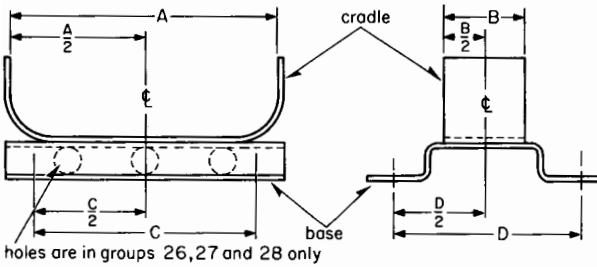

Figure 47

group	dimensions in inches				E (no. of spots)	core reference
	A	B	C	D		
17	1 <sup>13</sup> / <sub>16</sub>	5/8	1 <sup>1</sup> / <sub>16</sub>	1 <sup>7</sup> / <sub>16</sub>	2	Z-100
18	2 <sup>3</sup> / <sub>8</sub>	3/4	2 <sup>1</sup> / <sub>8</sub>	1 <sup>3</sup> / <sub>4</sub>	2	Z-101
19	2 <sup>1</sup> / <sub>2</sub>	3/4	2 <sup>1</sup> / <sub>8</sub>	1 <sup>3</sup> / <sub>4</sub>	2	Z-102
20	2 <sup>9</sup> / <sub>16</sub>	7/8	2 <sup>19</sup> / <sub>64</sub>	1 <sup>55</sup> / <sub>64</sub>	2	Z-103
21	2 <sup>13</sup> / <sub>16</sub>	7/8	2 <sup>5</sup> / <sub>8</sub>	2 <sup>1</sup> / <sub>8</sub>	4	Z-104
22	2 <sup>15</sup> / <sub>16</sub>	1	2 <sup>5</sup> / <sub>8</sub>	2 <sup>1</sup> / <sub>8</sub>	4	Z-105
23	3 <sup>3</sup> / <sub>8</sub>	1	3	2 <sup>7</sup> / <sub>16</sub>	5	Z-106
24	3 <sup>7</sup> / <sub>16</sub>	1 <sup>1</sup> / <sub>8</sub>	3	2 <sup>7</sup> / <sub>16</sub>	5	Z-107
25	4 <sup>1</sup> / <sub>16</sub>	1 <sup>1</sup> / <sub>4</sub>	3 <sup>5</sup> / <sub>16</sub>	2 <sup>11</sup> / <sub>16</sub>	5	Z-108
26	4 <sup>13</sup> / <sub>16</sub>	1 <sup>1</sup> / <sub>4</sub>	3 <sup>11</sup> / <sub>16</sub>	3	5	H-499
27	4 <sup>1</sup> / <sub>16</sub>	1 <sup>1</sup> / <sub>2</sub>	3	2 <sup>7</sup> / <sub>16</sub>	5	H-500
28	5 <sup>1</sup> / <sub>16</sub>	1 <sup>1</sup> / <sub>2</sub>	3 <sup>11</sup> / <sub>16</sub>	3	5	H-501



## **APPENDIX B**

### **Core Listing**

by relative power handling capacity

page 6

catalog number	dimensions in inches				relative power handl'g capac'y	weight: pounds	catalog number	dimensions in inches				relative power handl'g capac'y	weight: pounds
	strip width	build up	wind-down width	wind-down length				strip width	build up	wind-down width	wind-down length		
	D	E	F	G				D	E	F	G		
<b>12 mil series A</b>						<b>12 mil series A</b>							
A-52	3/8	3/16	3/8	1 1/4	.078	.086	A-399	1 1/4	1/2	5/8	1 3/4	.548	.976
A-424	5/8	1/4	3/8	1 3/8	.081	.171	A-205	1 1/2	3/8	5/8	1 9/16	.55	.805
+A-1	5/8	1/4	1/2	1 1/8	.088	.161	A-416	3/4	3/4	5/8	1 9/16	.55	.981
A-889	3/8	1/4	3/16	1 9/16	.089	.224	+A-583	1 1/8	1/2	5/8	1 9/16	.55	.858
A-210	3/8	1/4	5/8	1 9/16	.092	.127	A-626	2	1/2	1/2	1 1/8	.563	1.24
+A-2	3/4	1/4	1/2	1 1/8	.106	.193	+A-8	1 1/4	3/8	5/8	1 11/16	.568	.761
A-252	5/8	5/16	1/2	1 1/8	.11	.21	A-713	1 3/8	7/16	5/8	1 9/16	.587	.888
A-231	3/4	5/16	1/2	1	.117	.236	A-358	3/8	7/16	5/8	2 1/2	.598	.742
A-373	3/4	9/32	7/16	1 3/8	.127	.225	+A-6	1	3/8	5/8	1 9/16	.611	1.02
A-335	3/4	9/32	9/16	1 1/8	.134	.229	A-375	1	1/2	1/2	2 1/2	.625	.964
A-584	1	5/16	1/2	1	.156	.317	A-227	1	5/8	5/8	1 5/8	.635	1.125
A-232	3/8	3/8	1/2	1	.164	.35	+A-758	1 1/2	5/8	7/16	1 9/16	.64	1.43
+A-4	3/4	3/8	7/16	1 3/8	.169	.324	A-80	1	1 7/32	5/8	1 11/16	.643	.932
A-325	5/8	9/32	5/8	1 9/16	.172	.238	A-374	1	3/8	3/4	2 5/16	.65	.695
A-479	1	1/4	1 1/16	1	.172	.266	A-168	1	5/8	5/8	1 11/16	.66	1.06
A-327	3/4	5/16	1/2	1 9/16	.183	.306	+A-326	3/4	5/8	5/8	2 1/2	.66	.866
A-279	5/8	1/2	7/16	1 3/8	.188	.376	A-354	1	1 1/16	5/8	1 9/16	.672	1.16
A-57	5/8	5/16	5/8	1 9/16	.191	.268	A-118	5/8	5/8	3/4	2 5/16	.677	.803
A-669	7/8	7/16	1/2	1 1/8	.215	.452	A-114	1 1/2	3/8	5/8	1 11/16	.682	.915
A-463	3/4	5/16	5/8	1 9/16	.228	.322	A-129	3/4	3/4	5/8	1 11/16	.682	1.09
A-207	5/8	5/16	5/8	1 11/16	.236	.306	A-69	1	5/8	5/8	1 3/4	.684	1.083
A-280	5/8	1/2	5/8	1 1/4	.245	.427	A-406	5/8	5/8	1 5/16	1 3/8	.686	.766
A-250	1 1/4	1/4	3/8	2 1/4	.263	.477	A-260	5/8	1/2	1	2 1/4	.704	.644
A-853	1	7/16	1/2	1 1/4	.273	.543	A-60	1	1 13/32	3/4	2 5/16	.705	.768
A-141	1	9/32	5/8	1 9/16	.275	.382	A-242	1 1/4	1 9/32	5/8	1 11/16	.709	.998
A-605	1	1/2	1/2	1 1/8	.281	.617	A-261	1 1/8	9/16	5/8	2	.71	1.125
+A-3	1	3/8	1/2	1 9/16	.294	.514	A-596	1 1/4	3/8	5/8	2 1/2	.733	.887
+A-434	3/4	1/2	1/2	1 9/16	.294	.547	A-726	7/8	5/8	3/4	1 11/16	.743	1.00
A-128	1 1/8	7/16	7/16	1 3/8	.296	.59	A-148	1 1/2	3/8	1 1/16	1 11/16	.75	.936
+A-5	1	5/16	5/8	1 9/16	.305	.43	+A-9	1 1/4	1/2	5/8	1 11/16	.757	1.08
A-349	7/8	1 1/32	5/8	1 11/16	.317	.44	+A-161	1	7/16	3/4	2 5/16	.758	.838
A-776	1 1/8	7/16	1/2	1 9/16	.323	.63	A-494	1 1/4	3/8	5/8	1 9/16	.762	1.27
A-243	1	1/2	1/2	1 5/16	.328	.665	A-200	7/8	3/8	1 5/16	2 1/2	.768	.674
A-87	1	7/16	1/2	1 9/16	.342	.62	A-458	1 3/8	1 11/32	1 3/16	2	.768	.804
A-395	1	1/2	7/16	1 9/16	.342	.716	A-312	1 1/8	7/16	5/8	2 1/2	.77	.956
A-746	3/4	1/2	5/8	1 9/16	.366	.583	A-85	1	3/8	1 3/16	1 3/4	.781	.68
A-415	1	5/16	5/8	1 11/16	.378	.492	A-321	1 3/8	1 15/32	9/16	2 3/16	.792	1.14
A-24	1	1/2	1/2	1 9/16	.391	.732	A-402	1 1/8	1/2	1/2	2 13/16	.793	1.176
A-341	1	1 1/32	1/2	1 3/4	.411	.72	A-271	1 1/2	7/16	5/8	1 11/16	.794	1.10
A-432	3/4	7/16	3/4	1 11/16	.446	.55	+A-10	1 1/4	3/8	3/4	2 5/16	.814	.871
+A-7	1	3/8	5/8	1 11/16	.453	.613	A-702	1 1/2	9/16	5/8	1 9/16	.823	1.34
A-831	3/4	1/2	5/8	1 9/16	.458	.754	A-470	1	1 1/16	5/8	1 11/16	.833	1.293
A-774	1 1/8	3/8	5/8	1 5/16	.462	.786	A-314	1 3/8	5/8	5/8	1 9/16	.839	1.40
A-712	1 1/4	7/16	5/8	1 3/8	.469	.748	A-45	1 1/8	5/8	5/8	1 11/16	.85	1.284
A-376	1	7/16	5/8	1 3/4	.478	.693	A-50	1	1 7/32	1	1 5/8	.863	.947
+A-81	1	1/2	5/8	1 9/16	.489	.765	A-195	1	1/2	3/4	2 5/16	.867	.98
+A-747	1 1/2	1/2	7/16	1 9/16	.512	1.07	A-256	1	1/2	3/4	2 5/16	.867	.98
A-25	1 1/4	3/8	1 1/16	1 5/8	.525	.70	A-714	1 1/2	1/2	1 1/16	1 11/16	.871	1.00
A-225	1	1/2	5/8	1 11/16	.528	.797	A-295	1 1/4	9/16	5/8	2	.878	1.27
+A-163	1	7/16	5/8	1 11/16	.529	.735	A-785	1 1/16	7/16	3/4	2 1/16	.887	1.03

\* preferred core sizes: These cores should be used wherever possible in designing new transformers. They are subject to maximum discount regardless of quantity ordered. See selling policy 46-700.

pg 7

catalog number	dimensions in inches				relative power hand'l'g capac'y	weight: pounds	catalog number	dimensions in inches				relative power hand'l'g capac'y	weight: pounds
	strip width	build up	win-dow width	win-dow length				strip width	build up	win-dow width	win-dow length		
<b>12 mil series A</b>							<b>12 mil series A</b>						
A-193	1 1/2	9/16	5/8	1 11/16	.89	1.39	A-440	1 1/4	1/2	5/8	3 1/2	1.369	1.57
A-328	1	9/16	5/8	1 13/16	.892	1.04	A-263	1 1/8	1/2	3/4	2 5/16	1.41	1.593
+A-32	1	3/4	5/8	1 13/16	.908	1.453	A-1076	2	3/8	1	1 7/8	1.41	1.34
A-206	2	3/8	5/8	1 11/16	.908	1.22	A-61	1/2	1 1/16	1 3/8	3	1.419	.962
A-654	1 1/8	3/4	5/8	1 3/4	.924	1.55	A-320	1 1/8	5/8	5/8	2 1/4	1.429	1.99
A-342	1 1/2	7/16	1 1/16	2 1/16	.93	1.15	A-631	1 1/4	7/8	1 1/16	1 15/16	1.459	2.26
A-359	1 1/8	17/32	5/8	2 1/2	.933	1.21	A-704	1 3/4	1 1/16	3/8	1 15/16	1.459	2.26
A-770	1 1/2	1/2	1/2	2 1/2	.938	1.37	A-322	1 1/8	3/4	3/4	2 1/2	1.463	1.83
A-126	1 1/4	5/8	5/8	1 15/16	.945	1.43	+A-138	1 1/4	1/2	1 15/16	2 1/2	1.465	1.35
A-59	1 1/8	1/2	3/4	2 1/4	.95	1.08	A-769	2	3/4	5/8	1 9/16	1.465	1.57
A-64	1 1/8	1/2	3/4	2 5/16	.976	1.109	A-315	1 1/8	1 1/16	1 1/16	1 15/16	1.49	2.14
A-170	1 1/4	1/2	5/8	2 1/2	.978	1.25	A-191	1	1/2	1 1/2	2	1.50	1.11
+A-454	1 1/2	9/16	5/8	1 15/16	1.021	1.50	A-336	1 3/4	1/2	3/4	2 5/16	1.517	1.72
A-703	1 5/8	5/8	5/8	1 3/4	1.032	1.69	A-277	1 1/4	9/16	5/8	3 1/2	1.537	1.80
A-313	1 1/4	17/32	5/8	2 1/2	1.038	1.342	A-644	1 3/4	9/16	5/8	2 1/2	1.538	2.01
A-455	2	7/16	5/8	1 15/16	1.058	1.467	+A-17	1	3/4	1 3/16	1 3/4	1.559	1.60
A-493	1 1/4	5/8	3/4	1 13/16	1.062	1.43	A-180	2	3/8	1 3/16	1 3/4	1.559	1.368
A-194	1 1/4	9/16	5/8	2 7/16	1.07	1.41	A-398	1 1/4	5/8	1/2	4	1.564	2.199
A-310	1	5/8	3/4	2 5/16	1.084	1.36	A-352	3/4	1 1/8	1 1/2	1 1/4	1.583	2.855
A-701	1 1/4	1/2	3/4	2 5/16	1.084	1.23	+A-28	1 1/2	5/8	3/4	2 5/16	1.628	1.94
A-1125	1 1/4	1/2	1/2	3 1/2	1.09	1.55	A-125	1 1/4	3/4	3/4	2 5/16	1.628	2.035
A-272	1 1/4	9/16	5/8	2 1/2	1.098	1.44	A-370	1 1/8	5/8	5/8	2 5/8	1.667	2.20
A-656	2 1/4	1/2	5/8	1 9/16	1.098	1.721	A-422	1 1/8	1	1	1 1/2	1.688	2.37
A-379	1	17/32	1 3/16	1 3/4	1.104	1.032	A-95	3/4	3/4	1	3	1.689	1.50
A-136	3/8	1/2	1 1/4	3 5/8	1.135	.728	A-886	1 3/4	5/8	5/8	2 1/2	1.70	2.31
A-392	7/8	9/16	1 5/16	2 1/2	1.153	1.088	A-164	1 1/2	1 5/16	5/8	1 15/16	1.703	2.93
A-42	1 1/4	2 5/32	5/8	1 15/16	1.182	1.915	A-291	1	1 23/32	2	1/2	1.719	4.63
A-90	1 3/8	17/32	1	1 5/8	1.186	1.30	A-716	1 3/4	5/8	1 3/16	1 15/16	1.72	2.09
A-121	1 3/8	17/32	1 3/16	2	1.186	1.375	A-382	7/8	9/16	1	3/2	1.722	1.36
A-286	1 1/2	9/16	1 5/8	7/8	1.199	1.476	A-278	1 1/2	9/16	1 1/16	3	1.74	1.97
+A-257	2	1/2	5/8	1 15/16	1.211	1.725	+A-12	1 1/2	1/2	1 5/16	2 1/2	1.758	1.62
A-394	1 3/8	1/2	1 1/16	2 9/16	1.212	1.415	A-174	1 1/4	5/8	3/4	3	1.758	1.89
A-175	1 1/4	1 1/16	1 1/16	2 1/16	1.221	1.67	A-728	1	1 1/16	1	2 9/16	1.763	1.632
A-41	1 1/8	1/2	3/4	2 15/16	1.239	1.28	A-483	1 1/2	1 1/16	3/4	2 9/16	1.789	2.18
A-400	1 1/4	9/16	1 1/16	2 9/16	1.24	1.483	A-450	1 1/2	3/4	3/4	2 1/8	1.794	2.33
A-715	1 5/8	9/16	3/4	1 13/16	1.241	1.62	A-833	2	3/4	5/8	1 15/16	1.82	2.86
A-727	1	5/8	7/8	2 5/16	1.265	1.33	A-176	1 1/4	1/2	1	3	1.875	1.535
A-262	3/4	3/4	3/4	3	1.266	1.421	A-410	1 3/8	5/8	3/4	2 15/16	1.891	2.05
A-360	1 1/4	5/8	5/8	2 5/8	1.281	1.67	A-293	1 3/4	5/8	3/4	2 9/16	1.898	2.25
A-348	1 3/4	5/8	5/8	1 7/8	1.283	1.96	A-307	1 3/8	1 1/16	7/8	2 5/16	1.914	2.065
+A-86	1	3/4	3/4	2 5/16	1.302	1.63	A-357	1 3/4	5/8	1	1 3/4	1.915	2.10
+A-11	1 1/2	3/8	1 5/16	2 1/2	1.32	1.16	A-438	1 1/4	1	3/4	2 1/16	1.934	2.80
A-803	1 1/2	9/16	5/8	2 1/2	1.32	1.74	A-425	2	9/16	3/4	2 9/16	1.949	2.27
A-123	3/4	3/4	1 5/16	2 1/2	1.32	1.335	+A-36	1 1/2	3/4	3/4	2 5/16	1.951	2.44
A-146	1 1/8	1/2	1 5/16	2 1/2	1.32	1.22	A-361	1 3/8	1 1/16	1 1/16	3	1.953	2.31
A-609	1 3/4	5/8	5/8	1 15/16	1.325	2.00	A-442	7/8	9/16	1	4	1.968	1.49
+A-405	2	1/2	1 1/16	1 15/16	1.333	1.76	A-482	1 1/2	9/16	1 5/16	2 1/2	1.975	1.86
+A-760	1 1/2	1	3/4	1 3/16	1.337	2.66	A-639	1 3/8	1 5/16	3/4	2 1/2	2.053	2.86
A-275	1 3/8	9/16	1 1/16	2 9/16	1.363	1.63	A-238	1 1/8	5/8	7/8	2 5/16	2.055	2.16
A-436	1 1/4	7/8	5/8	2	1.368	2.26	A-1124	1 3/8	3/4	7/8	2 5/16	2.08	2.34

+ preferred core sizes: These cores should be used wherever possible in designing new transformers. They are subject to maximum discount regardless of quantity ordered. See selling policy 46-700.

pg 8

catalog number	dimensions in inches				relative power hand'l'g capacity	weight: pounds
	strip width	build up	wind-down width	wind-down length		
	D	E	F	G		

12 mil series A

A-20	1½	1⅛	¾	2⅝	2.088	2.245
+A-145	2	5⁄8	¾	2⅝	2.169	2.58
A-94	1¼	¾	7⁄8	2⅝	2.213	2.56
+A-13	1½	½	1	3	2.25	1.842
A-420	¾	¾	2	2	2.252	1.518
A-182	1⅝	¾	1⅝	2¾	2.294	2.37
A-334	1¼	1	2⅝	2½	2.301	2.88
A-318	1⅝	1⅛	1⅛	3	2.307	2.725
A-184	¾	¾	1¾	3	2.322	1.61
A-640	1	¾	1¼	2½	2.345	1.90
A-317	1⅝	¾	¾	2¼	2.374	3.00
A-610	2	1⅛	¾	2⅝	2.386	2.91
A-292	1¾	5⁄8	¾	2⅝	2.411	2.61
A-251	1⅝	¾	1⅝	2½	2.415	2.435
A-495	2	¾	1	1⅝	2.438	2.95
A-281	1½	5⁄8	¾	3½	2.464	2.52
A-836	1¾	1⅛	¾	2¾	2.48	2.82
A-661	1½	¾	1⅝	2¾	2.503	2.584
A-127	2	¾	¾	2¼	2.531	3.20
A-475	¾	¾	1½	3⅛	2.587	1.66
A-705	2	1⅜	¾	2½	2.588	3.44
A-329	2	¾	¾	2⅝	2.601	3.25
A-729	1⅝	¾	1½	2¾	2.613	2.185
+A-49	1½	¾	1⅝	2½	2.635	2.66
A-717	2	1⅛	7⁄8	2¼	2.709	2.96
A-751	1½	1⅛	¾	3½	2.709	2.70
A-443	1½	2⅜	1	2⅝	2.764	2.59
+A-330	1	1⅝	1	3	2.811	2.64
A-38	1½	5⁄8	1	3	2.814	2.395
A-504	2	9⁄16	1	2⅝	2.88	2.56
A-448	1½	¾	1	2⅝	2.882	2.73
A-362	1½	¾	¾	3½	2.954	3.14
+A-14	2	½	1	3	3.00	2.48
A-117	2½	1⅜	1	3	3.045	2.41
A-270	1¼	1⅜	1	3	3.045	2.75
A-384	1½	1⅛	1⅝	2¼	3.047	2.48
A-773	2⅜	5⁄8	¾	2⅝	3.05	3.62
+A-267	1½	1⅛	1	3	3.096	2.68
A-377	1	1¼	1¼	2	3.126	3.38
A-23	2	½	1⅜	2⅛	3.193	2.39
A-308	1½	¾	1	3½	3.283	2.64
A-178	2	5⁄8	¾	2⅝	3.304	3.74
A-397	1¾	2⅜	¾	3⅝	3.336	3.337
A-764	1½	1	1⅝	2¾	3.339	3.75
A-177	1½	¾	1	3	3.375	2.99
A-412	2	2⅜	1⅛	3¾	3.386	3.69
A-333	1	1⅝	1¼	3	3.513	2.76
A-179	2	¾	1⅝	2½	3.515	3.55
A-444	1½	1	1⅝	2½	3.515	3.85
A-486	1¾	7⁄8	1⅝	2½	3.588	3.77

catalog number	dimensions in inches				relative power hand'l'g capacity	weight: pounds
	strip width	build up	wind-down width	wind-down length		
	D	E	F	G		

12 mil series A

A-730	1¼	7⁄8	1¼	2⅝	3.591	2.92
+A-18	1¾	½	1¾	3	3.609	2.322
A-453	1¾	1	1⅝	2¼	3.69	3.29
A-311	1⅝	¾	¾	3½	3.693	3.92
A-611	2¼	1⅜	7⁄8	2⅝	3.697	4.17
A-247	1¾	2⅝	1	3	3.738	3.46
A-39	2½	½	1	3	3.75	3.07
A-802	2	2⅝	¾	3	3.81	3.99
A-854	2	5⁄8	1⅝	2¾	3.85	3.15
A-369	1⅝	¾	1⅜	2⅛	3.892	3.16
A-387	1⅝	1⅛	1⅝	3½	3.92	3.76
+A-185	1¾	5⁄8	1⅝	3½	3.945	2.56
A-718	2¼	¾	1⅝	2½	3.955	4.00
A-139	1⅝	1⅜	1	3	3.96	3.58
A-706	2¼	7⁄8	7⁄8	2⅝	3.984	4.60
A-881	2⅜	7⁄8	5⁄8	2⅝	4.04	5.83
A-269	1¾	1¾	¾	3½	4.06	1.045
A-259	1⅝	2⅝	1⅝	3½	4.088	3.75
A-300	2	7⁄8	1⅝	2½	4.10	4.31
A-592	2	5⁄8	1¼	2⅝	4.103	3.111
A-391	1	1	1¾	3	4.125	3.055
+A-15	2	1⅛	1	3	4.128	3.58
A-258	2¼	5⁄8	1	3	4.218	3.58
A-268	1¾	1⅜	1	3	4.263	3.86
A-181	2½	¾	1⅝	2½	4.393	4.44
A-439	1½	2⅝	1¼	3	4.395	3.60
A-104	1¼	1½	2⅝	3	4.452	1.98
A-445	1½	1	1⅝	2½	4.455	4.05
A-255	7⁄8	¾	1⅝	4⅜	4.464	2.37
+A-48	2	¾	1	3	4.50	3.98
+A-111	1½	1	1	3	4.50	4.30
A-212	1¾	1⅛	1¾	3½	4.554	2.89
A-419	2½	2⅜	1⅝	2¾	4.634	4.44
A-290	1½	¾	1¾	3	4.641	3.205
A-347	2	1	1⅝	2½	4.685	5.14
A-171	2½	5⁄8	1	3	4.689	3.99
A-449	2	5⁄8	1¼	3	4.689	3.36
A-244	1¾	1⅛	1⅝	3½	4.739	3.12
A-240	1½	1	1	3	4.875	4.65
A-27	1¼	1⅛	1¼	3	4.98	4.04
A-58	1¾	9⁄16	1	5⅞	5.043	3.56
A-140	2½	½	1¾	3	5.157	3.31
A-302	1¼	1	1¾	3	5.157	3.79
A-130	2	7⁄8	1	3	5.25	4.84
A-340	1¾	1⅝	1¾	3	5.313	3.87
A-165	1¾	¾	1¾	3	5.415	3.74
A-731	1½	7⁄8	1¾	3	5.415	3.87
A-707	2½	1⅝	1⅝	2½	5.488	5.88
A-612	2½	7⁄8	1⅝	2¾	5.638	5.69
A-396	1¾	1⅜	1	4	5.684	4.596

+ preferred core sizes: These cores should be used wherever possible in designing new transformers. They are subject to maximum discount regardless of quantity ordered. See selling policy 46-700.



pg 9

catalog number	dimensions in inches				relative power handl'g cap'c'y	weight: pounds	catalog number	dimensions in inches				relative power handl'g cap'c'y	weight: pounds
	strip width D	build up E	wind- down width F	wind- down length G				strip width D	build up E	wind- down width F	wind- down length G		
<b>12 mil series A</b>							<b>12 mil series A</b>						
A-456	2 1/4	7/8	1 5/16	2 1/4	5.812	4.986	A-509	2 13/16	2 9/32	1 3/16	3	9.081	7.35
A-719	2 1/2	1 3/16	1	2 7/8	5.836	5.36	A-761	2	1 5/16	1	3 1/2	9.184	8.79
A-301	1 1/2	3/4	1 3/8	3 7/8	5.995	3.74	A-622	3 3/8	1 1/2	3/4	2 7/16	9.253	14.42
+A-16	2	1	1	3	6.00	5.73	+A-54	2 1/2	1	1 3/16	3 3/8	9.281	7.56
A-429	1	7/8	1 3/4	4	6.124	3.22	A-447	2	1 1/8	1 3/8	3	9.282	7.12
A-421	1	1	1 3/4	3 1/2	6.125	3.52	+A-187	2 1/2	1 1/4	1	3	9.375	9.60
+A-19	2	3/4	1 3/8	3	6.189	4.28	A-499	2	1 7/16	1 3/16	2 3/4	9.389	9.18
A-601	1 1/2	1 3/8	1	3	6.189	6.54	A-1103	2	1	1 1/4	3 1/2	9.63	6.65
A-390	1 3/4	7/8	1 3/8	3	6.315	4.52	A-63	1 3/4	3/4	1 1/4	6	9.846	5.72
A-508	2 13/16	3/4	1	3	6.327	5.60	+A-393	2 1/2	7/8	1 5/16	3 1/2	10.049	6.96
A-305	7/8	3/4	2 3/8	4 3/16	6.525	2.62	A-814	2 13/16	7/8	7/8	4 1 1/16	10.08	8.79
A-834	1 3/4	3/4	1 1/8	4 1/2	6.62	4.56	+A-119	2 1/2	1	1 3/8	3	10.314	7.64
A-1070	2 3/4	1 3/32	1 5/8	4 3/16	7.54	4.10	A-981	2	1 1/4	1 3/8	3	10.32	8.16
A-309	2 1/2	1/2	1 5/16	4 1/16	6.662	3.96	+A-196	2 1/4	1 1/8	1 3/8	3	10.44	8.00
A-437	2	1 5/16	1 3/16	3	6.678	5.45	A-586	2 1/2	1 1/8	1 3/16	3 1/8	10.444	8.804
A-83	1 1/4	9/16	1 5/16	7 3/8	6.80	3.48	A-655	2 1/4	1 1/4	1 3/16	3 1/8	10.444	9.09
A-253	1 1/4	1 1/4	1 1/4	3 1/2	6.839	5.41	A-284	2 1/2	1 1/16	1	4	10.62	9.15
A-414	2 1/4	1	1 5/16	3 1/4	6.851	6.66	A-51	2	1	1 3/8	3 7/8	10.656	7.04
A-441	1	1	1 3/4	4	7.00	3.78	A-380	1 3/8	1 3/8	1 3/4	4 1/2	10.725	7.48
A-457	1	7/8	2	4	7.00	3.33	A-198	1 3/4	3/4	1 3/4	4 1 1/16	10.773	5.16
A-304	7/8	3/4	2 9/16	4 3/16	7.04	2.69	A-471	1 3/8	1	1 3/4	4 1/2	10.827	5.56
+A-37	2 1/4	2 7/32	1 3/16	3 1/8	7.05	5.51	A-477	2 1/2	1 1/16	1 3/8	3	10.953	8.27
A-423	2	1 3/16	1	3	7.128	7.18	A-582	2 1/4	1 5/8	1	3	10.968	10.50
A-588	2 1/4	1	1 1/8	2 7/8	7.277	6.44	+A-355	2 1/4	1 1/8	1 1/4	3 1/2	11.074	8.50
A-82	1 1/4	9/16	1 1 1/16	6 1/4	7.419	3.21	A-709	3	1	1 3/16	3 1/8	11.138	9.07
A-40	2	1	1 3/16	3 1/8	7.425	6.05	A-216	2 1/4	7/8	1 3/8	3 1/2	11.20	6.599
A-215	1	1	2 1/4	3 5/16	7.452	3.68	A-418	1 1/8	1 1/16	2	4 1 1/16	11.204	5.17
A-708	2 1/2	1	1	3	7.50	7.16	A-883	1 1/2	1 3/8	1 3/8	3 3/8	11.30	7.60
A-202	1 3/4	1 5/16	1 5/16	3 1/2	7.532	5.30	A-585	2	1 3/16	2 3/8	2 1 5/16	11.328	5.50
A-105	1 1/2	3/4	1 3/8	4 7/8	7.542	4.32	A-651	2 1/2	1	1 5/16	3 1/2	11.48	8.22
A-407	2 1/4	2 9/32	1 3/16	3 1/8	7.569	6.025	A-733	1 3/4	1 1/8	1 3/4	3 3/8	11.63	4.34
A-413	2 1/4	2 9/32	1 3/16	3 1/8	7.569	6.02	A-754	3 3/8	1 5/16	1 3/16	3 1/8	11.738	9.40
A-428	1 1/2	3/4	1 5/8	4 3/16	7.656	4.06	A-608	2	1 7/16	1 3/8	3	11.856	9.79
A-732	1 1/2	1	1 5/8	3 3/16	7.772	4.92	+A-266	2 1/4	1	1 3/8	3 7/8	11.989	7.92
A-613	2 3/4	7/8	1 1/8	2 7/8	7.783	6.65	A-452	2	1	2	3	12.00	6.773
A-364	1 3/8	1 3/8	1 3/8	3	7.80	6.36	A-614	3	1	1 1/4	3 1/4	12.188	9.38
+A-102	1 1/2	1 5/16	1 3/8	3	8.118	6.52	A-188	2 1/2	1 5/8	1	3	12.189	13.70
A-474	1 5/8	1/2	2	5	8.13	3.27	A-98	2	1 1/16	1 7/16	4	12.208	7.80
A-461	2 13/16	1 3/16	1 1/4	2 7/8	8.205	6.35	A-590	2	1 3/8	1 7/16	3 1/8	12.35	9.52
+A-35	2	1	1 3/8	3	8.25	6.10	A-650	3	1	1 3/8	3	12.375	9.18
A-332	2	1	1 3/16	3 1/2	8.316	6.45	+A-254	2 1/4	1 3/16	1 3/8	4 3/16	12.434	6.70
A-331	2 1/2	1 3/16	1 3/8	3	8.373	5.90	A-468	1 3/4	1	1 3/4	4 1/16	12.442	6.67
A-595	1 1/8	3/4	2 3/4	3 5/8	8.414	3.29	A-151	1 5/8	1 1/8	1 5/8	4 3/16	12.443	6.90
A-720	2 3/4	7/8	1 3/16	3	8.574	7.72	A-462	2 13/16	1	1 1/2	3	12.654	8.79
A-66	2 1/4	7/8	1 1/4	3 1/2	8.614	6.20	+A-467	2 13/16	1 3/32	1 3/8	3	12.69	9.64
A-476	1 3/8	1 1/16	1 5/8	5 5/8	8.646	4.07	A-865	2 1/2	1 1/8	1 1/4	3 3/8	12.70	9.50
A-134	1	1	1 13/16	4 7/8	8.84	4.27	A-600	2 3/4	1 5/16	1 7/16	3 1/2	12.961	8.55
A-372	2 1/2	1	1 3/16	3	8.91	7.40	A-367	2	1 1/4	1 3/8	3 7/8	13.322	9.311
A-132	2	1 1/2	1	3	9.00	9.80	A-491	2 1/4	7/8	1 3/8	4 3/16	13.402	7.31
+A-53	2 1/4	7/8	1 5/16	3 1/2	9.041	6.26	A-510	2 13/16	1 3/16	1 1/4	3 1/4	13.572	10.95

+ preferred core sizes: These cores should be used wherever possible in designing new transformers. They are subject to maximum discount regardless of quantity ordered. See selling policy 46-700.

pg 10

catalog number	dimensions in inches				relative power handl'g capac'y	weight: pounds
	strip width	build up	wind-down width	wind-down length		
	D	E	F	G		

**12 mil series A**

A-338	1 3/4	1 1/8	1 1/8	4 1/4	13.60	7.78
A-189	2	1	1 1/8	4 1/4	13.80	7.45
A-1127	2 3/4	1	1 7/16	3 1/2	13.80	9.19
A-378	1 1/4	1 1/8	1 1/8	4 3/16	13.82	8.79
A-417	1 1/2	1 1/8	1 3/4	4 1 1/16	13.848	7.16
A-84	1 1/8	1 3/16	2	5 1/4	13.86	5.83
+A-203	2 1/4	1 1/8	1 1/8	3 3/8	13.881	8.85
A-29	2 1/2	1	1 1/16	3 9/16	13.91	8.63
A-466	2 1 3/16	1 5/16	1 1/8	3 3/8	14.00	9.14
A-426	1 3/8	1 3/8	1 3/4	4 1/4	14.063	7.98
A-107	1 1/4	1 1/4	3	3	14.067	6.44
A-323	2 1/4	1 1 1/16	1 3/16	3 3/8	14.10	13.65
A-623	3 3/8	1 1/2	1	2 1 3/16	14.237	16.08
A-508	1 3/4	1 1/8	1 1/8	4 1/2	14.40	8.04
A-591	2 1/2	1 1/16	1 7/16	3 1/8	14.728	11.20
A-306	2	1	1 3/4	4 1/4	14.875	7.82
A-634	2 1/4	1	1 1/8	4 7/8	15.083	9.08
A-465	1 1/4	1 1/4	1 1/16	7 3/8	15.126	8.62
A-249	1 1/2	1 1/2	1 1/2	4 1/2	15.188	9.71
A-386	2	1 1/8	1 1/8	4 3/16	15.311	8.80
A-1076	2 1/2	3/8	1 1/2	4 1 1/16	15.40	8.50
A-473	2 1/2	1 1/2	1 3/8	3	15.468	13.01
A-801	1 1/4	1 1/4	2 3/8	4 3/16	15.50	6.88
A-511	2 1 3/16	1 3/16	1 1/8	4 3/16	15.537	8.36
A-469	1 3/4	1 1/8	1 1/8	4 7/8	15.60	8.42
+A-514	3 3/8	1 1/8	1 3/8	3	15.663	12.10
A-810	3 3/8	1 1/8	1 3/8	3	15.70	11.90
+A-287	2 1/4	1	1 3/4	4	15.752	8.50
A-777	1 1/2	1 1/2	1 3/4	4	15.752	9.43
A-625	3 3/8	1 1/8	1 3/8	3 1/16	15.987	12.13
A-388	2	1 3/16	1 1/8	4 3/16	16.17	9.42
A-734	1 7/8	1 1/4	1 3/4	4	16.408	9.32
A-433	2 1/4	1 3/8	1 3/8	3 3/8	16.484	11.84
A-710	3 1/4	1 1/4	1 1/4	3 1/4	16.507	13.51
A-630	2	1 1/2	1 9/16	3 9/16	16.692	11.60
A-500	2 1 3/16	3/8	1 1/8	4 3/16	16.748	9.13
A-122	2 1/2	1	1 3/8	4 7/8	16.76	10.10
A-615	3 1/4	1 1/8	1 1/16	3 1/2	16.79	12.42
A-113	1 3/4	1 3/16	1 3/4	4 1 1/16	17.055	8.94
A-593	2 1/4	1 1/8	1 1/8	4 3/16	17.225	9.44
A-721	3 1/4	1 1/16	1 7/16	3 1/2	17.364	11.65
+A-759	2 1 3/16	2	1 1/16	3	17.919	20.46
A-389	1 1/8	1 1/8	1 1/8	4 3/16	17.975	11.43
A-337	2 1/4	1 1/8	1 3/4	4 1/16	17.991	9.91
A-484	2 1/4	1 3/4	1 1/16	3 1/2	18.085	15.40
A-218	1 1/8	1 1/8	1 1/8	4 1/4	18.241	11.50
A-512	2 1/4	1 1/2	1 1/8	3 3/8	18.509	12.80
A-274	2 1/2	1 3/32	1 1/8	4 3/16	18.611	9.68
A-430	2	1	2	4 1 1/16	18.752	8.54
A-513	3 3/8	1 1/2	1 3/16	3 3/8	18.797	17.41

catalog number	dimensions in inches				relative power handl'g capac'y	weight: pounds
	strip width	build up	wind-down width	wind-down length		
	D	E	F	G		

**12 mil series A**

A-283	2 1/2	1 5/16	1 7/16	4	18.852	12.70
A-237	2 1/2	1 1/8	1 3/8	4 7/8	18.857	11.65
A-771	2 1/4	1 1/2	1 1/8	3 3/8	19.88	13.10
A-435	2 1/4	1 3/16	1 1/4	6	20.046	12.61
A-1144	2 3/4	1 3/32	1 5/8	4 3/16	20.40	11.60
A-620	3 1/8	1 1/4	1 1/2	3 1/2	20.507	14.03
A-350	2 1/2	1 1/2	1 1/8	3 3/8	20.567	14.25
A-324	1 1/2	1 7/16	2 3/16	4 3/8	20.637	9.86
A-806	3 3/8	3/4	1 1 3/16	4 7/8	20.704	9.52
+A-459	2 1 3/16	1 3/32	1 1/8	4 3/16	20.90	11.90
A-248	1 1/8	1 1/8	1 1/8	4 7/8	20.924	12.37
A-750	2 1/4	1 3/8	1 1/8	4 3/16	21.057	12.65
A-624	3 3/8	1 1/2	1 5/16	3 3/16	21.178	17.90
A-762	3 1/2	2 3/32	1 5/16	4 3/16	21.581	11.82
A-735	2	1 3/8	1 1 3/16	4 3/8	21.801	11.77
A-749	2 1 3/16	1 3/32	1 1/8	4 3/16	22.125	12.66
A-898	3 1/4	1 1/8	1 3/8	4 1/2	22.622	28.58
A-446	2 1/2	1 1/16	1 1/8	4 1/4	22.653	13.44
A-356	2	2	1 7/16	4 1/8	23.711	18.02
A-427	2 1/2	1 1/4	1 3/4	4 1/2	24.611	13.28
A-898	1 1/2	3/4	2 7/8	7 3/8	24.659	6.82
A-507	2	2	1 3/8	4 1/2	24.75	18.70
+A-480	2 1 3/16	1 3/32	1 3/4	4 1 1/16	25.20	12.90
A-502	2 1/2	1 9/16	1 7/16	4 1/2	25.25	16.97
A-192	1 1/8	1 1/4	2	5 7/16	25.489	11.40
A-982	2 1/2	1 1/2	1 1/8	4 3/16	25.50	15.80
A-893	3 1/2	1	2 1/8	4 7/8	25.90	11.10
A-711	2 1/2	1 3/8	1 3/8	3 3/8	25.645	18.24
A-488	2 1/2	1 1/2	1 1/8	4 1/4	25.90	16.00
A-1134	2 1/2	1	2 1/4	4 9/8	26.00	10.90
A-743	3 1/2	1 3/32	1 1/8	4 3/16	26.058	14.80
A-460	2 1 3/16	1 1/8	1 1/8	4 3/16	26.317	15.94
A-478	2 1 3/16	1 1 3/32	1 1/8	4 3/16	26.908	16.40
A-722	3 1/2	1 3/16	1 1/8	4	27.028	15.86
A-1167	2 7/8	1 1/16	1 3/4	4 1/4	28.00	15.60
A-635	3	1 3/8	1 1/8	4 3/16	28.072	17.00
A-778	2 1 3/16	1 7/8	1 3/8	3 3/8	28.094	22.30
A-411	1 3/4	1 3/4	1 3/4	5 1/4	28.14	15.477
A-580	2 1 3/16	1 1/16	1 1/4	4 3/8	28.245	15.60
A-503	2 1 3/16	1 3/8	1 3/4	4 1/4	28.26	16.33
A-621	3 3/4	1 3/8	1 1/2	3 3/4	29.003	19.73
A-748	1 3/4	2 1/4	1 3/4	4 1/4	29.291	19.46
+A-431	2	2 7/8	7/8	2 9/16	30.345	3.35
+A-519	2 1 3/16	1 3/32	2	5	30.76	13.90
A-1074	2	1 7/8	1 3/4	4 3/8	31.20	18.40
A-775	1 1/8	1 9/16	2 3/16	5 3/8	31.236	13.40
A-997	1 3/4	1 1/2	1 1/2	8	31.60	16.10
A-907	3 3/8	1 1 3/32	1 1/8	4 3/16	32.30	19.50
A-1069	3 3/8	3/4	2 1/8	6 1/16	32.60	12.30
A-616	3 1/2	1 1/4	1 3/4	4 1/4	32.538	18.00

\* preferred core sizes: These cores should be used wherever possible in designing new transformers. They are subject to maximum discount regardless of quantity ordered. See selling policy 46-700.

catalog number	dimensions in inches				relative power hand'l'g capac'y	weight: pounds
	strip width	build up	wind-down width	wind-down length		
	D	E	F	G		

catalog number	dimensions in inches				relative power hand'l'g capac'y	weight: pounds
	strip width	build up	wind-down width	wind-down length		
	D	E	F	G		

**12 mil series A**

A-648	3½	1¾	1¾	4¾	32.754	19.85
A-481	2 13/16	1½	2¼	3¾	33.807	17.82
A-636	3¾	1 5/16	2	5 1/16	34.384	14.59
A-296	2½	1¾	1¾	4½	34.452	20.38
+A-516	3 3/8	1¼	1 11/16	4 7/8	34.505	17.48
A-515	3¾	1 5/16	1 13/16	4¾	35.105	19.00
A-736	2¼	1½	2¼	4¾	36.072	16.20
A-517	3 3/8	1¾	1 13/16	4 7/8	37.957	19.70
+A-627	3 3/8	1 1/8	1 3/8	5 13/16	38.319	17.22
A-599	3 3/8	1½	1½	5½	38.676	22.70
A-742	3½	1¾	1¾	4¾	38.71	24.30
A-723	4	1 5/16	1¾	4¼	39.032	21.87
A-657	3½	1¼	1¾	5¼	40.194	20.30
+A-518	3 3/8	1 7/32	1 7/8	5 13/16	41.509	18.90
A-629	2 13/16	2 3/16	1 5/8	4 3/8	41.876	29.40
A-780	2½	2¼	1¾	4¼	41.90	27.20
A-649	3 3/8	1 5/32	2	5 7/16	42.43	18.69
A-622	2½	2 3/32	2	5	42.98	21.60
A-535	3	1 1/8	2¼	5¾	43.666	17.10
+A-533	3 3/8	1 5/32	2 3/16	5¾	44.466	18.00
A-604	2 13/16	2 15/16	1¼	4 5/8	47.749	45.00
A-627	2 1/8	1¾	2 1/8	6 1/8	48.406	24.90
A-908	2 13/16	1 7/16	1 1/2	8	48.50	24.30
A-632	3 3/8	1¼	2 1/2	5	48.825	19.14
A-921	3	1¾	1¼	7 1/2	49.20	32.60
A-949	3 3/8	1 7/8	1¾	4 1/2	49.90	29.60
A-520	4	1¼	2	5	50.00	23.20
A-856	3½	1¾	1 7/8	5 5/8	50.70	24.00
+A-523	3¾	1¾	2	5 7/16	50.466	23.08
+A-745	1¾	3	2	5	52.50	31.20
A-737	2½	1 11/16	2½	5	52.75	21.87
A-603	3 3/8	2 15/16	1¼	4 5/8	53.063	50.00
A-617	4	1½	1 7/8	4¾	53.438	27.90
A-724	4¼	1 7/16	1 13/16	4 7/8	53.947	27.88
A-524	3¾	1¼	2 1/8	6 1/16	54.346	22.20
A-753	3¾	1 15/32	2	5	55.09	27.00
+A-521	4	1 7/16	2	5	57.48	27.60
+A-763	4	1 5/8	1 7/8	4¾	57.893	30.53
A-664	3½	1¾	1 7/8	6 7/16	58.00	24.00
+A-525	3¾	1 11/32	2 1/8	6 1/16	58.432	24.20
A-638	3½	2¼	1¾	4¼	58.569	39.00
+A-529	3¾	1 13/32	2 1/8	6 9/16	63.644	26.20
A-969	4	2	1 5/8	5 1/8	66.60	40.30
+A-534	3¾	1 13/32	2 3/16	6 1/16	69.90	29.00
A-872	2¾	2¾	1¾	5¼	69.50	44.00
A-960	3¾	1¾	2¼	4¾	70.10	32.60
A-738	2¾	1 13/16	2¾	5¼	71.941	27.62
A-725	4½	1 5/8	2	5	73.13	35.36
A-1009	2¾	2¾	1 7/8	5¼	74.50	44.90
+A-536	3¾	1 13/32	2¼	6 9/16	77.852	30.60

**12 mil series A**

A-1151	4½	1½	2 1/8	5 7/16	78.00	35.80
A-618	4	1 11/16	2 1/8	5½	78.914	26.00
+A-757	4	2¼	1 7/8	4¾	80.156	46.47
A-652	3¾	1 12/32	2 1/8	6 1/8	80.826	34.96
+A-526	4	1 5/16	2 1/8	6 1/8	81.322	34.80
A-857	3¾	1¾	2 1/8	5 7/8	81.90	36.20
+A-537	3¾	1 15/32	2¼	6¾	83.666	32.70
+A-555	2½	1 25/32	2¾	7 3/16	88.024	29.50
A-871	3	2 13/16	1 7/8	5 5/8	89.00	52.30
A-602	4	1 13/16	2 1/8	5 7/8	90.487	40.80
A-821	3¾	1 7/8	2¼	5¾	91.00	39.40
+A-530	4	1 5/16	2 1/8	7 3/16	95.435	38.60
A-545	2¼	4	2 3/8	8	96.20	36.20
A-752	4	1 5/16	2 1/8	7 9/16	100.401	39.40
A-739	3	2	2 13/16	6¼	105.45	37.55
+A-558	2½	1 25/32	2¾	8 5/8	105.622	34.00
A-547	3½	1½	2 1/2	8 1/16	105.814	35.30
+A-559	2½	1 13/16	2¾	8 5/8	107.45	33.20
A-1140	2½	3 3/8	2	6	108.00	62.80
+A-833	4	1 12/32	2¼	7¼	108.054	41.74
A-556	3¾	1½	2¾	7 7/8	109.644	34.40
+A-543	4	1 12/32	2¾	7 5/16	115.032	42.70
+A-539	4	1 13/16	2¼	7¼	118.233	46.50
A-667	4	1 5/16	2 5/16	8¼	119.171	42.40
A-531	4	2	2 1/8	7 3/16	122.196	50.70
A-538	4	2 1/32	2¼	6¾	123.383	51.50
A-741	2 13/16	1¾	3 1/16	8¼	124.311	35.90
A-951	2½	2½	2 11/16	7 1/2	126.00	46.00
A-1071	4	2	2 1/2	6¾	127.50	50.00
A-1133	4	2 1/2	2¾	5¾	127.70	62.10
+A-540	4	1 13/16	2¼	8 1/8	132.503	50.30
A-1177	4½	2¼	2 1/8	6¼	134.60	61.60
+A-564	2 13/16	1 29/32	3 1/16	8¼	135.399	40.30
A-1147	4	2¼	2¼	6¾	136.70	57.50
A-1073	4	1½	2¾	8½	140.30	42.00
A-977	3¾	2 1/2	2¼	6¾	142.40	62.90
A-967	5½	2 1/2	1 5/8	6 7/16	144.20	84.10
A-532	4	1 5/16	2 1/8	11	146.00	50.60
A-549	4	1 13/16	2 1/2	8 1/16	146.083	51.00
A-830	4	2 7/16	2	7 5/8	148.70	67.10
A-544	4	2 3/16	2 1/8	7 5/16	151.987	59.80
+A-548	4	1 29/32	2 1/2	8 1/16	153.662	53.70
A-914	3 3/8	2 1/2	2¾	7¼	155.70	59.70
A-1135	4	2 7/16	2	8 1/8	158.40	70.60
A-740	3¼	2 3/16	3¼	6 7/8	158.888	49.45
+A-586	2 13/16	1 31/32	3 1/16	9 3/8	159.00	45.10
A-541	3½	2 3/8	2¼	8 1/8	167.968	69.20
A-968	5½	2 5/8	1 7/16	8 1/8	168.20	101.00
A-546	4¼	2 3/16	2 1/2	7 5/16	170.00	64.20
A-890	3¼	3¼	2 1/2	6 1/2	171.60	77.40

† preferred core sizes: These cores should be used wherever possible in designing new transformers. They are subject to maximum discount regardless of quantity ordered. See selling policy 46-700.

pg 12

catalog number	dimensions in inches				relative power handl'g capac'y	weight: pounds
	strip width	build up	win-dow width	win-dow length		
	D	E	F	G		

catalog number	dimensions in inches				relative power handl'g capac'y	weight: pounds
	strip width	build up	win-dow width	win-dow length		
	D	E	F	G		

**12 mil series A**

**12 mil series A**

A-1148	4 1/2	3 3/8	2 1/8	5 7/8	176.00	90.50
*A-571	2 13/16	2 3/32	3 3/8	9 5/8	176.00	49.10
A-867	3 1/4	3 3/8	2 1/2	6 1/2	178.10	79.50
A-569	3 1/8	2	3 1/8	9 5/8	187.00	51.60
*A-570	3 3/8	2 1/16	3 1/8	9 5/8	193.00	54.00
A-557	5	1 12/32	2 3/4	8 5/8	196.00	60.20
*A-572	3 3/8	2 1/16	3 5/16	9 5/8	205.00	54.30
A-870	3 3/4	3 3/8	2 1/2	6 1/2	205.60	91.60
*A-561	3 3/8	2 7/32	3	10	208.00	58.90
A-551	4	1 29/32	2 1/2	11 1/4	214.00	66.60
A-550	4	2 1/16	2 1/2	8 1/16	216.707	80.90
A-1100	4 5/8	3 3/4	2 1/4	6 3/4	217.80	131.50
A-562	3 3/8	2 7/32	3	10	224.00	64.00
A-1188	4	3 1/4	2 3/8	7 5/16	226.00	96.00
A-957	5 1/2	2 3/4	1 7/16	10 7/16	226.50	125.60
A-542	4	3 3/8	2 1/4	8 3/8	228.516	99.40
A-573	3 3/8	2 5/16	3 5/16	9 5/8	230.00	62.20
A-1263	6	2	2 5/8	7 5/16	230.00	83.00
A-1160	4 1/2	4	2 1/8	6 1/16	232.20	132.00
A-575	2 1/2	2 1/2	3 1/2	10 3/4	233.00	59.20
A-552	4 1/2	1 29/32	2 1/2	11 1/4	242.00	75.00
A-967	4	3	2 1/2	8 1/8	243.80	94.20
A-553	4	2 3/16	2 1/2	11 1/4	246.00	81.10
A-1249	7 1/2	1 3/4	2 1/4	8 1/2	251.00	94.50
A-1259	6	2 1/4	2 5/8	7 5/16	259.00	94.50
A-565	5 5/8	1 29/32	3 1/16	8 1/4	270.00	79.50
A-577	3 1/4	2 1/8	4	10	276.00	62.40
A-1002	3 3/2	4 1/4	2 3/4	6 3/4	276.80	125.30
A-554	4	2 1/16	2 1/2	11 1/4	277.00	98.50
A-1248	7 1/2	2	2 1/4	8 1/2	287.00	112.00
A-563	3 1/8	3 1/8	3	10	292.00	91.50
A-567	5 1/8	1 29/32	3 1/16	9 3/8	307.00	86.00
A-574	5	2 1/32	3 3/8	9 1/16	312.00	82.50
A-578	2	3	4	13	312.00	68.00
A-956	7 1/2	2 3/8	1 9/16	11 1/4	312.80	151.00
A-1162	5	3 3/8	2 3/4	6 3/4	313.20	130.00
A-568	5 5/8	1 31/32	3 1/8	9 5/8	332.00	92.00
A-1243	5	3 3/4	2 3/4	6 3/4	348.00	150.00
A-950	4 7/8	3 3/4	2 3/8	8 3/8	363.50	155.50
A-955	7 1/2	2 7/8	1 9/16	11 1/4	379.70	192.00
A-938	6	3 1/4	3 3/8	5 1/8	387.50	140.00
A-994	4 7/8	4	2 3/8	8 3/8	387.80	173.00
A-930	6 1/2	3	3 1/4	6 3/16	392.20	139.50
A-964	5	3 1/2	1 9/16	14 1/2	395.90	194.00
A-579	3 3/4	2 1/4	4 1/2	11	418.00	83.60
A-1255	6 1/2	2 5/32	3	10	420.00	119.00
A-576	4 1/2	2 1/4	3 3/4	11 5/8	440.00	97.20
A-1146	4 7/8	3 1/2	2 3/8	9 7/8	443.40	160.00
A-1239	5 1/4	3 5/8	2 3/4	8 5/8	451.00	170.00
A-988	7 1/2	2 5/16	3 7/8	6 1 5/16	464.80	130.00

A-1179	5	3	3	10 3/4	466.90	140.00
A-1149	6	3 1/4	3 1/16	8 1/8	492.50	164.00
A-1198	5	3 1/4	3	10 3/8	506.00	152.00
A-966	7 1/2	3	1 9/16	14 1/2	510.40	241.00
A-961	3 1/4	4	3 1/2	11 5/8	528.90	143.00
A-925	6	3 1/2	3 1/16	8 1/4	530.60	181.00
A-1138	6	3 3/8	3 1/16	9 5/8	538.00	163.00
A-965	7 1/2	3 1/4	1 9/16	14 1/2	552.50	265.00
A-928	6	3 3/4	3 1/16	8 1/4	568.50	201.00
A-1240	7 1/2	2 3/16	3 5/16	10 1/2	570.00	147.00
A-1200	5 3/8	3 3/8	3 3/8	9 1/16	596.00	179.00
A-1099	7 1/2	4 3/8	2 1/4	8 1/2	627.30	301.00
A-970	7 1/2	4 3/8	2 1/4	8 1/2	627.30	293.00
A-1104	7 1/2	3 3/4	1 9/16	14 1/2	636.60	316.00
A-936	7 1/2	3 1/2	3 5/8	6 3/4	642.30	212.30
A-929	6 1/4	2 1 1/16	3 3/8	12 3/8	675.90	175.00
A-1197	5 3/4	4 1/4	3 3/8	9 1/16	698.00	222.00
A-1228	5	4 3/4	3	10 3/8	739.00	252.40
A-1199	5 3/8	4 5/8	3 3/8	9 1/16	761.00	247.00
A-1037	6	5 1/4	3 1/16	8 1/4	795.90	320.00
A-937	5 7/8	3 1/8	3 3/4	11 5/8	799.80	191.50
A-1056	7 1/2	3 3/4	2	14 1/2	814.90	335.00
A-942	6	3 1/8	3 3/8	11 5/8	817.40	196.00
A-958	6	4 3/4	3 1/16	9 3/8	818.40	297.80
A-946	4	3	6	12 3/4	918.00	145.00
A-1245	6 1/2	2 13/16	4 1/8	12 1/2	944.00	198.00
A-1105	7 1/2	5	3 7/8	6 15/16	1008.00	354.00
A-927	6 1/2	3	4	13 1/8	1024.00	219.00
A-1229	5	4	4	13 3/16	1065.00	242.00
A-959	7 1/8	3 7/8	4 1/2	11	1190.00	304.00
A-953	5 7/8	4 3/4	4 3/4	8 3/4	1195.00	299.00
A-1084	7 1/2	5 1/2	2	14 1/2	1196.00	543.00
A-954	5 7/8	5	4 3/4	8 3/4	1221.00	320.00
A-1154	6 7/8	4 1/2	4	10	1236.00	333.00
A-1090	7 1/2	6 1/4	3 3/8	6 15/16	1260.00	484.30
A-935	6 1/2	3 7/8	4	13 1/8	1323.00	300.00
A-1024	5 1/2	4 9/16	4 3/4	12 1/4	1435.00	310.00
A-989	6 7/8	6	4	10	1680.00	504.00
A-1196	6 1/2	5 1/4	4	13 3/8	1790.00	438.00
A-1224	6	4	5	18	2160.00	360.00

\* preferred core sizes: These cores should be used wherever possible in designing new transformers. They are subject to maximum discount regardless of quantity ordered. See selling policy 46-700.

catalog number	dimensions in inches				relative power handl'g capac'y	weight pounds	catalog number	dimensions in inches				relative power handl'g capac'y	weight pounds
	strip width	build up	wind-down width	wind-down length				strip width	build up	wind-down width	wind-down length		
	D	E	F	G			D	E	F	G			
<b>4 mil series H</b>							<b>4 mil series H</b>						
H-459	¼	⅜	¼	½	.004	.013	H-504	¾	¾	¼	⅞	.061	.23
+H-568	¼	⅜	¼	¾	.005	.016	+H-39	¾	¼	½	1⅝	.062	.10
+H-121	¾	⅜	¼	½	.006	.02	+H-114	½	¼	½	1	.063	.124
+H-447	¼	¾	¼	¾	.008	.026	+H-139	¾	¾	¾	1⅜	.063	.146
H-569	¾	7/64	¼	¾	.008	.133	+H-456	½	¾	⅝	1⅞	.063	.178
+H-231	¾	¾	¼	¾	.011	.039	H-513	¾	17/64	½	1¼	.063	.105
+H-283	¼	¼	¼	¾	.014	.046	+H-363	¾	9/32	¾	1	.066	.154
+H-172	¾	¼	¼	¾	.015	.056	+H-552	¾	5/16	1	1¼	.066	.18
+H-549	½	¾	¼	¾	.015	.053	H-619	¾	5/16	5/16	1⅝	.068	.196
H-671	1½	¾	½	1⅞	.016	.26	+H-137	¾	¼	¾	1⅜	.07	.145
+H-530	½	7/32	¼	¾	.018	.063	+H-1	½	¼	½	1⅞	.071	.122
H-629	½	⅜	½	1⅞	.018	.025	H-607	½	¾	5/16	1	.073	.215
H-676	1	¾	½	1⅞	.021	.402	H-307	¾	¾	¾	17/16	.076	.164
H-525	¾	¼	¼	¾	.021	.068	H-98	¾	¼	7/16	1⅞	.077	.148
+H-590	¾	7/32	¼	¾	.021	.081	H-679	½	5/16	7/16	1⅞	.077	.155
+H-589	¾	¼	5/16	¾	.025	.071	H-342	½	½	5/16	1	.078	.262
+H-99	¾	7/32	5/16	1	.026	.065	+H-2	¾	3/16	½	1⅞	.08	.13
+H-215	½	¼	¼	¾	.027	.091	H-677	¾	¾	½	1⅞	.08	.151
+H-430	¾	¾	¾	1	.027	.056	H-197	½	¾	¾	1⅞	.08	.189
+H-246	¾	¼	5/16	1	.029	.077	+H-407	¾	¼	¾	1⅞	.08	.172
H-606	¾	3/16	¾	1⅞	.03	.06	+H-251	½	5/16	7/16	1⅜	.081	.16
+H-531	½	¼	5/16	¾	.034	.095	H-446	½	¾	7/16	1	.082	.183
H-615	½	3/16	¾	1	.035	.075	+H-40	½	¼	½	1⅝	.083	.134
+H-115	¾	¼	¾	1	.035	.08	+H-217	½	¾	¾	1⅜	.084	.195
+H-425	¾	7/32	¼	¾	.036	.112	+H-553	¾	5/16	5/16	1	.085	.24
H-116	¾	¼	¾	1⅞	.039	.085	H-356	¾	9/32	7/16	1⅞	.087	.171
H-402	½	3/16	¾	1⅞	.039	.081	H-140	¾	¼	½	1⅞	.088	.148
H-125	¾	¼	5/16	1⅞	.04	.113	H-364	½	5/16	½	1⅞	.088	.16
H-588	½	¾	¾	¾	.041	.153	H-567	½	1⅝	7/16	1⅜	.089	.181
+H-38	¼	¼	½	1⅝	.042	.067	+H-380	¾	¼	¾	1⅞	.092	.20
+H-235	¾	¼	¾	1⅜	.042	.088	H-622	¾	5/16	7/16	1⅝	.096	.211
H-156	½	¼	½	1⅞	.043	.094	+H-201	½	¾	¾	1⅞	.098	.212
+H-551	¾	¼	5/16	¾	.043	.12	H-678	½	5/16	9/16	1⅞	.099	.164
+H-210	¾	¾	5/16	1	.044	.129	H-111	½	½	¾	1⅞	.10	.269
H-532	½	7/32	5/16	1	.044	.118	+H-252	½	5/16	7/16	1⅜	.101	.20
+H-250	½	¼	¾	1	.047	.107	+H-41	¾	¼	½	1⅝	.102	.167
H-636	½	¼	¼	1⅞	.047	.14	+H-108	¾	¾	¾	1⅜	.105	.244
H-276	½	3/16	¾	1⅞	.048	.093	+H-3	¾	¼	½	1⅞	.106	.183
H-110	¼	¼	¾	1⅝	.051	.071	H-174	¾	½	½	1⅞	.106	.219
H-367	¾	5/16	¾	1⅜	.052	.116	+H-187	½	¾	½	1⅞	.106	.202
H-672	¾	¼	½	1⅞	.053	.092	H-621	1⅞	5/16	1⅝	¾	.106	.298
H-233	¼	⅜	¾	2⅝	.053	.049	H-180	¾	5/16	½	1⅞	.11	.20
H-620	½	3/16	5/16	1⅜	.054	.064	+H-43	¾	5/16	¾	1⅜	.114	.157
H-398	½	7/32	½	1	.055	.098	H-404	¾	¾	½	1	.117	.237
H-684	½	¼	7/16	1⅞	.058	.114	H-385	¾	¼	½	1¼	.118	.196
H-365	½	7/32	½	1⅞	.058	.101	H-261	¾	¾	¾	1⅞	.121	.266
H-199	½	7/32	¾	1	.059	.141	+H-328	¾	1⅝	¾	1¼	.121	.271
+H-203	½	¼	¾	1¼	.059	.122	+H-554	¾	5/16	¾	1⅜	.121	.274
+H-382	¾	¼	¾	1	.059	.133	+H-42	¾	¼	½	1⅝	.123	.201
+H-360	¾	5/16	5/16	1	.061	.17	+H-269	½	¾	½	1⅝	.123	.218

+ preferred core sizes: These cores should be used wherever possible in designing new transformers. They are subject to maximum discount regardless of quantity ordered. See selling policy 46-700.

pg 14

catalog number	dimensions in inches				relative power handl'g capac'y	weight: pounds	catalog number	dimensions in inches				relative power handl'g capac'y	weight: pounds
	strip width D	build up E	wind-down width F	wind-down length G				strip width D	build up E	wind-down width F	wind-down length G		
<b>4 mil series H</b>							<b>4 mil series H</b>						
H-270	1/2	7/16	1/2	1 1/8	.124	.245	H-101	1	1/4	1/2	1 1/16	.211	.314
H-327	7/8	3/16	1/2	1 1/2	.125	.183	H-216	3/4	3/8	1/2	1 1/2	.212	.354
+H-361	3/4	3/8	3/8	1 3/16	.125	.293	H-351	3/4	1/2	1/2	1 1/8	.212	.439
H-519	5/8	3/8	3/8	1 7/16	.126	.273	H-189	1 1/8	1/4	1/2	1 9/16	.22	.336
H-637	1	3/4	3/4	2 5/16	.13	1.60	+H-245	3/4	3/8	1/2	1 9/16	.22	.363
H-160	3/8	3/8	1/2	1 1/8	.132	.252	H-428	3/4	3/8	5/8	1 1/4	.22	.337
+H-391	5/8	3/8	5/8	1 1/2	.132	.186	H-243	5/8	5/8	1/2	1 1/8	.221	.495
H-674	1	3/16	5/8	1 1/8	.132	.185	+H-46	3/4	5/16	5/8	1 9/16	.228	.306
H-173	1/2	1/2	1/2	1 1/16	.133	.284	H-214	1	9/32	1/2	1 5/8	.229	.351
H-316	3/8	3/8	5/8	1 9/16	.137	.19	H-424	3/4	1/4	3/8	1 15/16	.229	.271
+H-484	1 1/4	1/4	3/8	1 3/16	.139	.297	H-230	1	1/4	1/2	1 7/8	.234	.338
+H-138	1/2	1/2	1/2	1 1/8	.141	.293	H-345	1	5/16	1/2	1 1/2	.234	.378
H-169	1/2	3/8	1/2	1 1/2	.141	.237	H-103	5/8	5/16	3/8	1 15/16	.236	.29
+H-4	7/8	7/32	1/2	1 1/2	.144	.218	H-277	1	5/16	1/2	1 9/16	.244	.387
H-157	1 1/4	3/8	5/16	1	.146	.431	H-338	1	1/4	5/8	1 9/16	.244	.314
H-405	5/8	3/8	1/2	1 1/4	.146	.266	H-177	5/8	1/2	1/2	1 9/16	.245	.434
H-176	3/8	1/2	1/2	1 9/16	.147	.26	H-186	1 1/4	1/4	1/2	1 9/16	.245	.373
+H-304	3/8	3/16	1/2	1 1/2	.147	.237	+H-105	3/4	3/8	3/4	1 9/16	.251	.345
H-124	7/8	1/4	7/16	1 9/16	.15	.254	+H-129	3/8	7/16	1/2	1 9/16	.251	.466
+H-9	3/8	1/4	5/8	1 9/16	.153	.196	H-282	5/8	1/2	3/8	1 9/16	.257	.413
+H-44	1/2	5/16	5/8	1 9/16	.153	.204	H-631	5/8	7/16	1/2	1 7/8	.257	.402
+H-253	3/8	3/8	1/2	1 5/16	.154	.273	H-158	1	3/8	5/16	2 1/4	.263	.566
H-127	1/2	3/8	5/8	1 9/16	.155	.23	H-348	1	3/8	9/16	1 1/4	.264	.436
+H-310	3/4	3/8	1/2	1 1/8	.159	.303	+H-47	7/8	5/16	3/8	1 9/16	.267	.356
H-318	1	1/4	1/2	1 5/16	.164	.268	H-314	1 1/8	1/4	9/16	1 1 1/16	.267	.363
H-109	3/4	1/2	1/2	7/8	.165	.392	H-190	1/2	3/8	7/8	1 5/8	.268	.283
H-149	3/8	9/32	5/8	1 9/16	.172	.225	+H-50	1/2	3/8	3/4	1 15/16	.273	.30
H-584	7/8	1/4	1/2	1 9/16	.172	.261	+H-11	1	9/32	5/8	1 9/16	.275	.361
H-202	5/8	3/8	1/2	1 1/2	.176	.296	+H-556	1 1/8	3/8	1/2	1 9/16	.277	.493
H-290	1/2	9/16	1/2	1 1/4	.176	.361	+H-408	3/8	7/16	7/16	1 1 1/16	.282	.525
+H-175	5/8	1/2	1/2	1 1/8	.177	.366	H-663	3/8	7/16	1/2	1 1/2	.288	.50
H-457	7/8	5/16	1/2	1 5/16	.18	.305	+H-6	3/4	1/2	1/2	1 9/16	.294	.52
H-434	1/2	1/4	3/4	1 11/16	.182	.188	+H-7	1	3/8	1/2	1 9/16	.294	.483
H-383	3/4	5/16	1/2	1 9/16	.183	.29	+H-409	7/8	1 3/32	7/16	1 15/16	.30	.523
H-374	3/4	1/4	5/8	1 9/16	.184	.257	H-179	1 3/8	9/32	1/2	1 9/16	.301	.471
+H-254	3/4	3/8	1/2	1 9/16	.185	.328	+H-48	1	5/16	5/8	1 9/16	.305	.406
+H-5	1	1/4	1/2	1 1/2	.188	.291	H-219	5/8	3/8	5/8	1 1/4	.305	.543
H-279	1/2	1/2	1/2	1 1/2	.188	.34	H-668	1 1/16	1 3/32	5/8	1 3/4	.305	.409
+H-464	1	1/2	3/8	1	.188	.523	H-171	5/8	1/2	5/8	1 9/16	.306	.452
+H-555	1 1/8	3/8	3/8	1 3/16	.188	.441	H-585	3/4	1/2	5/8	1 9/16	.307	.496
+H-45	5/8	5/16	5/8	1 9/16	.191	.254	H-152	1/2	7/16	1 3/16	1 3/4	.312	.347
H-308	5/8	3/8	5/8	1 5/16	.192	.287	H-349	1	1 3/32	5/8	1 1/4	.318	.497
+H-183	1/2	1/2	1/2	1 9/16	.195	.346	H-371	7/8	3/8	5/8	1 9/16	.32	.443
H-104	3/4	3/8	5/8	1 1/8	.198	.319	+H-376	1	7/16	7/16	1 1 1/16	.322	.60
H-326	3/4	1 1/32	1/2	1 9/16	.201	.326	H-675	1 1/4	3/8	1/2	1 3/8	.323	.56
H-377	5/8	3/8	5/8	1 3/8	.201	.295	H-200	1	3/8	1/2	1 3/4	.329	.519
H-335	1/2	1/2	1/2	1 5/8	.203	.355	H-51	5/8	3/8	3/4	1 15/16	.341	.375
H-683	1	1/4	9/16	1 7/16	.203	.303	H-117	5/8	9/16	5/8	1 9/16	.342	.527
+H-49	3/8	3/8	3/4	1 19/16	.205	.225	+H-403	3/8	1/2	1/2	1 9/16	.342	.607
+H-381	7/8	7/16	3/8	1 7/16	.205	.465	+H-379	1	1 3/32	7/16	1 15/16	.343	.598

+ preferred core sizes: These cores should be used wherever possible in designing new transformers. They are subject to maximum discount regardless of quantity ordered. See selling policy 46-700.

catalog number	dimensions in inches				relative power hand'l'g capac'y	weight: pounds	catalog number	dimensions in inches				relative power hand'l'g capac'y	weight: pounds
	strip width D	build up E	wind- down width F	wind- down length G				strip width D	build up E	wind- down width F	wind- down length G		
<b>4 mil series H</b>							<b>4 mil series H</b>						
H-632	3/4	3/8	5/8	1 1/16	.343	.428	H-58	5/8	7/16	7/8	2 1/4	.538	.503
+H-557	1 1/4	7/16	1/2	1 5/16	.358	.664	+H-54	1	3/8	3/4	1 15/16	.544	.599
H-100	1	3/8	5/8	1 9/16	.366	.506	H-458	1 1/2	3/8	5/8	1 9/16	.55	.76
+H-255	3/4	1/2	5/8	1 9/16	.366	.543	H-350	1	1/2	1 1/16	1 5/8	.559	.755
H-510	1	1 5/32	1/2	1 9/16	.367	.637	H-237	1 1/8	9/16	3/4	1 3/16	.563	.869
+H-14	1 1/8	5/16	5/8	1 11/16	.37	.479	+H-558	1 1/2	1/2	1/2	1 1/2	.563	1.013
+H-372	7/8	7/16	5/8	1 9/16	.373	.536	H-618	1	1/2	1/2	2 1/4	.563	.861
+H-223	1	1/2	1/2	1 1/2	.375	.679	+H-17	1 1/4	3/8	5/8	1 15/16	.568	.722
H-161	5/8	5/8	5/8	1 9/16	.381	.604	H-512	3/4	5/8	5/8	1 15/16	.568	.81
H-384	1 1/4	5/16	5/8	1 9/16	.381	.509	H-257	3/4	9/16	3/4	1 13/16	.574	.711
+H-8	1	1/2	1/2	1 9/16	.391	.694	H-168	1	3/8	3/4	2 1/16	.579	.613
H-260	5/8	3/8	1	1	.391	.568	H-151	1	1 5/32	1/2	2 1/2	.588	.845
H-102	1 1/8	2 3/64	5/8	1 9/16	.395	.543	H-331	5/8	5/8	1/2	3	.588	.849
H-208	1 1/8	5/8	1/2	1 1/8	.396	.892	+H-369	1 1/8	7/16	1 1/16	1 3/4	.592	.72
H-386	3/4	3/8	3/4	1 7/8	.396	.441	H-357	1 1/8	7/16	5/8	1 15/16	.597	.781
H-681	1 1/4	3/8	3/8	2 1/4	.396	.724	+H-411	7/8	7/16	5/8	2 1/2	.598	.704
H-191	1/2	3/8	1 1/8	1 7/8	.398	.329	+H-224	1 1/8	9/16	9/16	1 11/16	.599	.97
H-600	1 1/4	3/8	3/8	1 3/8	.403	1.03	H-341	1	1/2	5/8	1 15/16	.606	.818
H-52	3/4	3/8	3/4	1 15/16	.409	.45	H-206	1 1/2	1/2	1 3/32	2	.61	1.319
H-340	1	7/16	3/8	2 1/2	.41	.749	+H-13	1	5/8	5/8	1 9/16	.611	.966
H-226	3/4	3/8	1 9/16	1 13/16	.413	.441	H-55	1 1/8	3/8	3/4	1 15/16	.614	.675
H-280	3/4	1/2	3/4	1 1/2	.422	.555	H-296	7/8	3/8	3/4	2 1/2	.615	.609
H-57	1/2	7/16	7/8	2 1/4	.432	.403	H-135	3/8	5/8	1 1/16	1 15/16	.635	.897
H-205	1 1/4	2 3/64	5/8	1 9/16	.439	.601	H-112	3/4	5/8	3/4	1 13/16	.638	.813
H-303	1	9/16	1/2	1 9/16	.439	.808	H-65	1/2	1/2	1	2 9/16	.641	.527
H-178	1 1/2	3/8	1/2	1 9/16	.44	.725	H-59	3/4	7/16	7/8	2 1/4	.646	.604
H-333	3/4	1/2	7/16	2 3/4	.451	.72	H-120	1	3/8	3/4	2 5/16	.65	.66
H-352	1	5/16	3/4	1 15/16	.453	.485	+H-20	1 1/4	5/16	3/4	2 5/16	.677	.668
+H-478	1	3/8	5/8	1 15/16	.453	.577	+H-56	1 1/4	3/8	3/4	1 15/16	.682	.751
H-306	1	7/16	5/8	1 11/16	.461	.64	H-212	1 1/2	3/8	5/8	1 15/16	.682	.864
+H-387	7/8	3/8	3/4	1 7/8	.461	.514	H-312	3/4	3/4	5/8	1 15/16	.682	1.03
H-107	1 1/8	3/8	5/8	1 3/4	.462	.611	H-395	3/4	5/8	3/4	1 15/16	.682	.841
H-292	1 1/4	5/16	5/8	1 15/16	.473	.582	H-572	1	1/2	3/4	1 15/16	.726	.848
H-53	7/8	3/8	3/4	1 15/16	.477	.524	H-119	1 3/8	3/8	1 1/16	2 1/16	.732	.825
H-353	1	7/16	5/8	1 3/4	.478	.655	H-162	1 1/2	1/2	5/8	1 9/16	.733	1.086
H-435	1 1/2	3/8	1	2 9/16	.482	.376	H-60	7/8	7/16	7/8	2 1/4	.752	.704
+H-12	1	1/2	5/8	1 9/16	.489	.724	+H-15	1	5/8	5/8	1 15/16	.757	1.082
H-401	1 1/4	1/2	1/2	1 9/16	.489	.868	H-479	1 1/4	1/2	5/8	1 15/16	.757	1.019
H-482	1 1/2	1/2	7/8	2 1/4	.493	.472	H-323	3/8	7/16	1	2	.764	.691
H-496	1 1/4	3/8	5/8	1 11/16	.495	.661	H-24	7/8	3/8	1 1/2	1/4	.768	.638
H-118	3/4	3/4	3/4	1 3/16	.501	.855	+H-410	1 1/8	7/16	5/8	1/4	.77	.906
+H-300	1	3/8	3/4	1 13/16	.509	.576	H-132	1	3/8	1 3/16	1 3/4	.781	.65
H-339	1	7/16	5/8	1 7/8	.512	.68	H-388	1 1/2	3/8	3/4	1 7/8	.791	.885
H-494	5/8	1/2	1 1/16	1 9/16	.519	.52	H-66	5/8	1/2	1	2 9/16	.802	.659
H-136	7/8	9/16	5/8	1 11/16	.52	.768	H-673	3/8	9/16	7/8	1 7/8	.808	.865
H-474	5/8	1/2	1 9/16	1 1/16	.52	.537	H-131	1 1/4	3/8	3/4	2 5/16	.814	.825
H-159	1	5/8	3/8	2 1/4	.527	1.083	+H-370	1 1/8	1/2	3/4	1 15/16	.817	.954
H-209	1	7/16	5/8	1 15/16	.529	.695	H-602	1 1/2	3/8	3/4	1 15/16	.817	.898
H-196	1	1 1/32	3/4	2 1/16	.532	.532	H-355	1	1 1/16	1 1/16	1 3/4	.828	1.14
+H-10	7/8	5/8	5/8	1 9/16	.534	.846	+H-16	1 1/8	5/8	5/8	1 15/16	.85	1.219

+ preferred core sizes: These cores should be used wherever possible in designing new transformers. They are subject to maximum discount regardless of quantity ordered. See selling policy 46-700.

pg 16

catalog number	dimensions in inches				relative power hand'l'g capacity	weight pounds
	strip width	build up	win-dow width	win-dow length		
	D	E	F	G		

catalog number	dimensions in inches				relative power hand'l'g capacity	weight pounds
	strip width	build up	win-dow width	win-dow length		
	D	E	F	G		

**4 mil series H**

H-236	1 3/8	7/16	1 1/16	2 1/16	.852	.997
H-305	1 1/8	7/16	3/4	2 5/16	.853	.89
+H-61	1	7/16	7/8	2 1/4	.86	.805
+H-559	1 5/8	9/16	9/16	1 1/16	.866	1.389
H-232	1	1/2	3/4	2 5/16	.867	.929
H-239	1	5/8	3/4	1 5/16	.908	1.12
H-265	1	3/4	3/8	1 5/16	.908	1.375
H-436	3/4	3/8	1 1/8	2 7/8	.909	.626
H-143	7/8	3/8	1 5/16	3	.921	.72
+H-413	1 1/8	1 1/32	5/8	2 1/2	.933	1.14
H-612	2	1/2	1/2	1 7/8	.938	1.33
H-397	1	1/2	5/8	3	.939	1.07
H-123	1 3/8	1 3/32	3/4	2 1/4	.943	.978
+H-18	1 1/4	5/8	5/8	1 5/16	.945	1.353
H-302	7/8	5/8	3/4	2 5/16	.948	1.077
H-455	7/8	3/4	3/4	1 5/16	.953	1.242
H-67	3/4	1/2	1	2 5/16	.961	1.791
H-150	1 3/8	1 3/32	3/4	2 5/16	.969	.997
H-62	1 1/8	7/16	7/8	2 1/4	.97	.907
+H-22	1 1/2	3/8	3/4	2 5/16	.976	.989
H-170	3/4	3/4	3/4	2 5/16	.976	1.153
H-134	7/8	5/8	1 1/16	1 1/16	.981	1.00
H-301	7/8	3/8	1	3	.984	.73
H-272	1	1/2	7/8	2 1/4	.986	.945
H-352	1 1/8	5/8	5/8	2 1/4	.988	1.31
H-613	1 1/8	9/16	1 3/16	1 5/16	.996	1.84
H-680	1 1/4	1/2	1 3/16	2	1.02	1.10
H-491	1 1/2	9/16	5/8	1 5/16	1.021	1.42
+H-412	1 1/4	1 1/32	5/8	2 1/2	1.038	1.222
H-429	1	1/2	1 3/16	1 3/4	1.04	.911
H-389	2	3/8	3/4	1 7/8	1.056	1.183
H-336	7/8	3/8	1 5/16	2 1/2	1.075	.699
+H-63	1 1/4	7/16	7/8	2 1/4	1.076	1.007
+H-347	1 1/4	1/2	3/4	2 5/16	1.084	1.162
H-537	1	5/8	3/4	2 5/16	1.084	1.22
+H-540	1 1/8	9/16	1 3/16	2 1/8	1.09	1.166
H-605	2	3/8	3/4	1 5/32	1.091	1.20
H-392	1 1/8	9/16	3/4	2 5/16	1.096	1.207
H-346	7/8	5/8	1 3/16	1 1/16	1.097	1.032
H-432	3/8	9/16	1 1/16	2 1/16	1.097	1.358
H-68	7/8	1/2	1	2 5/16	1.122	.922
H-75	5/8	9/16	1 1/8	2 7/8	1.136	.834
H-332	3/8	7/16	1	3	1.146	.873
+H-35	3/4	3/4	1 3/16	1 3/4	1.171	1.135
+H-64	1 3/8	7/16	7/8	2 1/4	1.184	1.106
H-259	1 1/4	5/8	5/8	2 7/16	1.189	1.525
H-366	1	3/4	5/8	2 5/16	1.202	1.58
H-153	1 1/4	9/16	3/4	2 5/16	1.218	1.343
H-502	1 1/2	5/8	7/8	1 1/2	1.232	1.536
H-133	3/4	3/4	1 1/4	1 2 5/32	1.254	1.16

**4 mil series H**

H-241	3/4	1 3/32	1 3/8	3	1.257	.741
H-69	1	1/2	1	2 5/16	1.281	1.054
+H-415	1 1/4	5/8	5/8	2 5/8	1.281	1.60
+H-27	1 1/2	3/8	1 5/16	2 1/2	1.32	1.096
H-181	3/4	3/4	1 5/16	2 1/2	1.32	1.261
H-146	1 3/4	5/8	5/8	1 5/16	1.325	1.892
+H-534	1 5/8	1 1/16	1 1/16	2 1/16	1.342	1.75
H-289	1 1/8	3/4	2 5/16	2 5/16	1.343	1.552
H-76	3/4	9/16	1 1/8	2 7/8	1.366	1.001
H-571	1	5/8	5/8	3 1/2	1.369	1.55
H-266	1 1/8	5/8	7/8	2 1/4	1.384	1.397
H-164	1 3/8	2 3/32	1 1/16	2 1/2	1.402	1.853
+H-414	1 3/8	5/8	5/8	2 5/8	1.41	1.756
H-141	1 1/8	1 5/32	1 1/8	2 3/8	1.411	1.084
H-154	1 3/8	1 9/32	3/4	2 5/16	1.417	1.579
+H-560	1 7/8	5/8	5/8	1 5/16	1.42	2.019
H-354	1 1/4	9/16	7/8	2 5/16	1.422	1.385
H-70	1 1/8	1/2	1	2 5/16	1.442	1.184
H-471	1 1/4	9/16	3/4	2 3/4	1.449	1.494
H-263	1 3/8	3/4	1 1/16	2 1/16	1.462	1.959
+H-19	1 1/8	3/4	3/4	2 5/16	1.463	1.736
+H-26	1 1/4	1/2	1 5/16	2 1/2	1.465	1.278
H-604	1 5/8	5/8	3/4	1 5/16	1.476	1.80
H-399	1	3/4	3/4	2 5/8	1.478	1.65
H-437	3/4	1/2	1 1/4	3 3/16	1.495	.954
H-334	1	1/2	1 1/2	2	1.50	1.05
H-390	1	1/2	1	3	1.50	1.162
H-113	1 3/4	1/2	3/4	2 5/16	1.517	1.625
H-220	1 3/4	3/8	1 5/16	2 1/2	1.538	1.28
H-322	1 1/4	7/8	5/8	2 1/4	1.539	2.386
H-228	1 1/2	1 9/32	3/4	2 5/16	1.544	1.718
+H-86	5/8	5/8	1 1/4	3 3/16	1.559	1.03
H-449	1 3/8	9/16	7/8	2 5/16	1.563	1.533
H-142	1 1/8	1 5/32	1 3/16	2 1/2	1.568	1.13
+H-541	1 1/4	5/8	7/8	2 5/16	1.579	1.577
H-295	1 1/4	1 3/16	5/8	2 1/2	1.585	2.163
H-77	7/8	9/16	1 1/8	2 7/8	1.593	1.166
H-71	1 1/4	1/2	1	2 5/16	1.601	1.317
H-248	1 1/2	5/8	3/4	2 5/16	1.628	1.833
H-313	1 3/8	1 9/32	1 3/16	2 1/2	1.658	1.675
H-293	1 1/8	3/4	3/4	2 3/4	1.741	1.916
+H-28	1 1/2	1/2	1 5/16	2 1/2	1.758	1.533
H-221	2	3/8	1 5/16	2 1/2	1.758	1.46
H-72	1 3/8	1/2	1	2 5/16	1.763	1.447
+H-21	1 3/8	3/4	3/4	2 5/16	1.787	2.115
H-489	1 1/8	3/4	1	2 1/8	1.794	1.75
H-467	1 1/8	5/8	1	2 5/16	1.801	1.55
H-309	1 3/8	9/16	1 5/16	2 1/2	1.81	1.62
H-431	1 1/2	5/8	1 5/16	2 1/16	1.812	1.804
H-78	1	9/16	1 1/8	2 7/8	1.817	1.334

+ preferred core sizes: These cores should be used wherever possible in designing new transformers. They are subject to maximum discount regardless of quantity ordered. See selling policy 46-700.



*17*

catalog number	dimensions in inches				relative power hand'l'g capac'y	weight: pounds	catalog number	dimensions in inches				relative power hand'l'g capac'y	weight: pounds
	strip width	build up	wind-down width	wind-down length				strip width	build up	wind-down width	wind-down length		
	D	E	F	G			D	E	F	G			
<b>4 mil series H</b>													
H-325	1	25/32	15/16	2 1/2	1.83	1.77	+H-542	1 5/8	3/4	1	2 9/16	3.123	2.799
H-204	1 3/8	3/4	3/4	2 3/8	1.836	2.144	H-84	1 3/4	9/16	1 1/8	2 7/8	3.183	2.333
H-87	3/4	5/8	1 1/4	3 3/16	1.868	1.237	H-421	1 1/2	1/2	1 5/8	3 1/2	3.203	1.62
H-472	1 1/2	1 7/32	1 5/16	2 1/2	1.868	1.649	H-264	1 3/4	5/8	1	3	3.282	2.638
H-73	1 1/2	1/2	1	2 9/16	1.922	1.581	+H-188	1 1/2	3/4	1	3	3.375	2.832
H-211	1 1/2	9/16	1	2 9/16	1.949	1.71	H-85	1 7/8	9/16	1 1/8	2 7/8	3.41	2.512
+H-23	1 1/2	3/4	3/4	2 9/16	1.951	2.309	H-92	1 3/8	5/8	1 1/4	3 3/16	3.424	2.27
+H-417	1 3/8	1 1/16	1 1/16	3	1.953	1.60	H-311	1 3/8	1 1/16	1 3/4	3 1/4	3.458	2.503
+H-561	2	1 1/16	1 1/16	2 1/16	1.953	2.555	H-242	1 1/2	1 5/16	1 5/16	2 1 1/16	3.54	3.482
H-106	1 1/2	5/8	1 5/16	2 1/4	1.978	1.901	H-37	1 3/4	1/2	1 3/8	3	3.609	2.202
H-267	1 1/8	3/4	1 5/16	2 1/2	1.978	1.892	H-344	1 1/4	1/2	1 1/2	3 7/8	3.635	1.88
H-498	1 1/4	1/2	1 1/8	2 7/8	2.021	1.45	H-501	1 1/2	3/4	1 5/16	3 1/2	3.689	3.10
H-79	1 1/8	9/16	1 1/8	2 7/8	2.044	1.502	+H-418	1 7/8	3/4	3/4	3 1/2	3.693	3.715
H-80	1 1/8	9/16	1 1/8	2 7/8	2.044	1.686	H-505	1 1/4	3/4	1 5/16	4 1/4	3.736	2.90
H-499	1 1/4	5/8	3/4	3 1/2	2.051	1.99	H-93	1 1/2	5/8	1 1/4	3 3/16	3.74	2.474
H-74	1 5/8	1/2	1	2 9/16	2.083	1.712	H-128	2	1/2	1 1/4	3	3.75	2.444
H-268	1	3/4	7/8	3 1/4	2.132	1.93	+H-36	1 3/8	5/8	1 5/16	3 1/2	3.945	2.425
H-288	1 1/2	5/8	1	2 5/16	2.169	1.95	H-94	1 3/8	5/8	1 1/4	3 3/16	4.049	2.677
H-88	7/8	5/8	1 1/4	3 3/16	2.181	1.44	+H-563	2 1/2	1 3/16	1 3/16	2 1/2	4.12	4.525
+H-29	1 1/2	5/8	1 5/16	2 1/2	2.198	2.001	H-337	1 1/4	5/8	1 3/8	3 7/8	4.162	2.377
H-450	3/4	3/4	1 1/4	3 3/16	2.244	1.54	H-493	2 1/4	5/8	1	3	4.218	3.40
+H-30	1 1/2	1/2	1	3	2.25	1.744	H-439	1	5/8	1 5/8	4 3/16	4.255	2.076
H-490	1 1/8	3/4	1 1/8	2 3/8	2.256	1.91	H-291	1 3/4	3/4	1 5/16	3 1/2	4.305	3.589
H-423	1 3/4	5/8	3/4	2 3/4	2.258	2.377	+H-95	1 3/4	5/8	1 1/4	3 3/16	4.361	2.881
H-438	1	1/2	1 5/16	3 1/2	2.296	1.363	+H-31	1 1/2	1	1	3	4.50	4.074
H-329	7/8	7/8	1	3	2.298	2.003	H-492	2	3/4	1	3	4.50	3.77
+H-416	1 5/8	1 1/16	1 1/16	3	2.307	2.585	+H-543	1 3/4	1 3/16	1 1/8	2 7/8	4.597	3.65
H-122	1 1/2	1/2	1 1/4	2 1/2	2.345	1.65	H-503	1 1/2	3/4	1 3/8	3	4.641	3.04
H-218	1 1/2	5/8	1 9/16	2 1 1/16	2.363	2.09	H-96	1 7/8	5/8	1 1/4	3 3/16	4.67	3.085
+H-406	1 3/8	1 1/16	1	2 9/16	2.424	2.129	H-294	1 1/8	3/4	1 9/16	3 3/16	4.695	2.595
H-271	1 1/2	3/4	1 5/16	2 5/16	2.437	2.41	H-441	1 3/8	3/4	1 5/16	3 1/2	4.736	3.017
H-603	2 1/4	3/4	3/4	1 1 5/16	2.452	3.15	H-192	1 3/4	3/4	1 1/8	3 1/4	4.80	3.54
H-523	1 7/8	1/2	3/4	3 1/2	2.464	2.30	H-227	2 1/4	3/4	1	2 7/8	4.853	4.13
H-89	1	5/8	1 1/4	3 3/16	2.49	1.649	H-422	1 3/8	5/8	1 3/8	4 1/8	4.872	2.72
H-81	1 3/8	9/16	1 1/8	2 7/8	2.501	1.833	H-32	1 3/8	1	1	3	4.875	4.414
H-165	1	9/16	1 5/16	3 1/2	2.58	1.562	H-617	2 1/2	7/16	1	4 1/2	4.91	3.32
H-394	1 1/2	1	3/4	2 5/16	2.601	3.376	H-451	1 1/2	1	1 5/16	2 1/2	4.92	3.929
H-213	2 1/4	1/2	1 9/16	2 1/2	2.635	2.299	H-97	2	5/8	1 1/4	3 3/16	4.983	3.298
H-500	1 1/2	3/4	1 5/16	2 1/2	2.635	2.516	H-486	1 1/8	1 1/8	1 3/4	3 3/16	5.047	3.83
H-82	1 1/2	9/16	1 1/8	2 7/8	2.726	1.998	H-420	1 3/8	5/8	1 3/8	3 5/8	5.064	2.964
H-225	1 3/4	5/8	1 5/16	2 1 1/16	2.755	2.444	+H-33	1 3/4	1	1	3	5.25	4.753
H-258	1 1/2	9/16	1 5/16	2 1/2	2.765	1.925	H-330	1 1/2	1	1	3 1/2	5.25	4.44
H-90	1 1/8	5/8	1 1/4	3 3/16	2.802	1.855	H-195	1 1/2	3/4	1 9/16	3	5.271	3.14
H-273	1 1/2	3/4	1	2 1/2	2.813	2.55	H-440	1 1/4	5/8	1 5/8	4 3/16	5.315	2.59
+H-562	2 1/4	3/4	3/4	2 5/16	2.927	3.47	H-460	1 3/4	1 3/16	1 3/8	3	5.445	3.628
H-83	1 3/8	9/16	1 1/8	2 7/8	2.953	2.168	H-274	2 1/4	2 1/32	1	3	5.697	4.92
+H-419	1 1/2	3/4	3/4	3 1/2	2.954	2.973	H-324	1 3/8	3/4	1 9/16	3 9/16	5.735	3.172
H-396	2	1/2	1	3	3.00	2.347	H-426	1 1/4	7/8	1 3/8	3 7/8	5.828	3.541
+H-25	1 3/8	1 5/16	1 9/16	2 1/2	3.018	3.074	+H-564	2 1/2	1 5/16	1 5/16	2 1 1/16	5.90	5.78
H-91	1 1/4	5/8	1 1/4	3 3/16	3.111	2.056	H-565	2	3/4	1 1/4	3 3/16	5.978	4.11

\* preferred core sizes: These cores should be used wherever possible in designing new transformers. They are subject to maximum discount regardless of quantity ordered. See selling policy 46-700.

pg. 18

catalog number	dimensions in inches				relative power handling capacity	weight: pounds
	strip width D	build up E	wind-down width F	wind-down length G		
<b>4 mil series H</b>						
H-147	1½	¾	1¾	3¾	5.995	3.531
+H-34	2	1	1	3	6.00	5.432
+H-155	2	¾	1¾	3	6.189	4.05
+H-358	1¾	1	15/16	3½	6.314	4.287
H-198	1¾	7/8	1¾	3	6.315	4.278
H-524	2¼	1	1	3	6.75	6.10
H-184	2	¾	15/8	3¾	6.855	3.65
H-443	1½	1	15/16	3½	6.888	4.675
+H-544	1¾	7/8	15/16	3½	7.032	4.62
H-535	2¼	13/16	1¾	3	7.536	5.02
H-373	2	25/32	17/16	37/16	7.716	4.656
H-454	2½	1	11/16	3	7.965	6.85
H-461	2	1	1¾	3	8.25	5.791
H-182	2½	29/32	19/16	3½	8.409	6.35
H-393	2¼	1¼	1	3	8.439	8.187
H-427	1½	1¾	1¾	3	8.511	6.606
H-130	2	23/32	17/16	4½	8.522	4.69
H-167	1	15/16	1½	4½	8.856	5.19
H-506	2½	¾	19/16	39/16	8.869	4.90
H-497	2	1	17/16	37/16	9.878	6.29
+H-545	2	1	1¾	3¾	9.969	6.41
H-400	2½	¾	1¾	3¾	9.99	5.893
H-256	2½	1	1	4	10.00	8.00
H-616	2½	7/16	2	4 1/16	10.20	3.96
H-249	1¾	1	1½	4	10.50	6.063
H-516	2	¾	1½	4	10.50	5.88
H-475	2	1	1¼	4¼	10.625	6.926
H-507	1½	1¾	1¾	39/16	10.686	7.025
H-481	2½	31/32	15/16	3½	11.127	7.479
H-319	2	1	1¼	4½	11.25	7.16
H-611	2¼	1	1¾	3¾	12.00	7.47
+H-546	2¼	1	1½	4	13.50	7.77
H-628	1½	1½	1¾	49/16	15.30	8.91
H-717	7¼	5	7	16	4060.00	546.00

+ preferred core sizes: These cores should be used wherever possible in designing new transformers. They are subject to maximum discount regardless of quantity ordered. See selling policy 46-700.

pg 19

catalog number	dimensions in inches				relative power handl'g capac'y	weight: pounds	catalog number	dimensions in inches				relative power handl'g capac'y	weight: pounds
	strip width	build up	wind-down width	wind-down length				strip width	build up	wind-down width	wind-down length		
	D	E	F	G			D	E	F	G			
<b>2 mil series L</b>							<b>2 mil series L</b>						
+L-1	1/4	1/8	1/4	1/2	.004	.013	+L-12	1/2	7/16	1/2	1 1/8	.124	.244
L-66	1/4	1/8	1/4	1/2	.004	.016	+L-11	3/4	3/8	3/8	1 3/16	.125	.293
L-163	1/4	5/32	1/4	1/2	.005	.019	L-216	3/8	3/8	3/8	1 9/16	.137	.191
L-305	3/8	1/8	1/4	1/2	.006	.021	+L-135	1/2	7/16	9/16	1 1/8	.138	.251
+L-2	1/4	3/16	1/4	3/8	.008	.027	L-167	1/2	7/16	1/2	1 1/4	.138	.258
+L-143	1/4	1/4	1/4	1/2	.008	.035	L-208	3/8	5/16	7/16	1 5/8	.138	.24
+L-147	1/4	1/8	5/16	1	.01	.023	L-33	3/2	1/2	1/2	1 1/8	.141	.293
L-161	1/4	1/4	1/4	3/8	.01	.039	L-142	1/4	3/8	1/2	1 1/8	.159	.303
+L-3	3/8	3/16	1/4	3/8	.011	.039	+L-78	3/4	5/16	5/16	2 1/4	.164	.342
+L-4	3/8	1/4	1/4	3/8	.014	.047	L-97	3/8	3/8	3/8	2	.176	.217
L-306	1/2	3/16	1/4	3/8	.015	.06	L-136	1/2	9/16	1/2	1 1/4	.176	.362
L-284	3/8	5/32	5/16	1	.018	.044	L-83	3/4	5/16	3/8	1 1/4	.183	.268
+L-5	3/8	1/4	1/4	7/8	.020	.067	L-107	3/8	5/16	3/8	1 1/2	.183	.246
L-281	5/16	1/4	5/16	3/8	.021	.058	L-45	3/8	1/2	7/16	1 3/8	.188	.393
L-71	3/8	3/16	5/16	1	.022	.053	+L-14	1/2	1/2	1/2	1 9/16	.195	.346
L-269	3/8	5/32	1/4	3/8	.023	.079	L-152	1/2	1/2	1/2	1 5/8	.203	.355
+L-7	3/8	7/32	9/16	1	.026	.064	L-202	1/2	7/16	1/2	1 7/8	.206	.325
+L-6	1/2	1/4	1/4	7/8	.027	.091	+L-18	1/2	7/16	3/8	1 9/16	.214	.305
L-76	3/8	3/16	3/8	1	.027	.05	L-131	1	7/16	1/2	1	.219	.466
L-37	3/8	7/32	5/16	1 1/16	.028	.068	L-207	1/2	7/16	1/2	2	.22	.339
L-114	3/8	7/32	5/16	1 1/8	.029	.072	L-211	3/4	3/8	1/2	1 9/16	.22	.364
L-132	3/8	1/4	5/16	1	.029	.076	L-181	3/8	5/8	1/2	1 1/8	.221	.495
L-151	5/8	1/4	3/16	1 1/8	.033	.116	L-153	1	3/8	1/2	1 3/16	.223	.41
L-62	1/4	1/4	1/2	1 1/8	.036	.063	L-169	1/2	7/16	3/8	1 5/8	.223	.313
+L-124	1/2	1/4	9/16	1	.039	.103	L-308	3/4	1/4	3/8	1 29/32	.225	.065
L-69	1/4	1/4	1/2	1 1/4	.04	.067	L-254	3/4	7/16	5/16	2 1/4	.23	.507
L-51	3/8	5/16	1 3/32	3/4	.041	.10	L-75	1	1 1/32	9/16	1 1/4	.241	.396
L-240	3/8	1/4	3/8	1 3/16	.042	.087	L-268	1/2	1/2	3/8	1 9/16	.244	.368
L-88	3/8	3/8	5/16	1	.044	.129	+L-15	5/8	1/2	1/2	1 9/16	.245	.436
L-247	1/4	1/4	7/16	1 9/16	.044	.071	L-32	1	7/16	1/2	1 1/8	.246	.494
L-261	3/8	5/32	3/8	1 3/16	.046	.101	L-190	1/2	3/8	7/8	1 1/2	.248	.274
L-123	1/2	1/4	3/8	1	.047	.106	L-166	3/4	1/2	3/8	1 1/8	.263	.462
L-138	3/8	1/4	1/2	1	.047	.084	L-219	1/2	7/16	3/8	1 15/16	.265	.345
L-40	1/4	1/4	1/2	1 9/16	.05	.081	L-42	3/8	5/8	1/2	1 3/8	.27	.544
L-267	1/4	1/4	3/8	1 9/16	.061	.081	L-28	1	7/16	1/2	1 1/4	.274	.531
L-121	3/8	1/4	1/2	1 5/16	.062	.099	L-203	1	1/2	1/2	1 1/8	.281	.585
L-8	3/8	3/8	3/8	1 3/16	.063	.147	+L-16	3/4	1/2	1/2	1 9/16	.294	.519
L-232	1/2	1/4	1/2	1 1/8	.071	.121	L-217	1/2	1/2	3/8	1 15/16	.302	.408
L-280	5/8	9/16	3/8	1	.073	.105	L-86	1	1/2	1/2	1 1/4	.313	.616
+L-9	1/2	3/8	3/8	1 3/16	.084	.197	L-250	1	5/8	3/8	1 3/8	.322	.825
+L-13	5/8	1/4	1/2	1 1/8	.088	.153	L-43	3/8	5/8	3/8	1 9/16	.381	.604
L-159	1/2	1/2	3/8	1	.094	.261	L-210	3/4	3/8	3/4	1 13/16	.382	.434
L-227	1/2	7/16	3/8	1 3/16	.097	.238	L-30	3/8	9/16	3/8	1 1/4	.385	.661
L-41	3/8	3/8	1/2	1 3/8	.098	.169	+L-17	1	1/2	1/2	1 9/16	.391	.693
L-50	5/8	1/4	1/2	1 1/4	.098	.162	L-39	3/8	1/2	3/8	2	.392	.58
L-94	5/8	5/16	5/16	1 5/8	.099	.228	L-307	7/8	3/8	5/8	1 11/16	.397	.50
L-272	5/8	9/32	1/2	1 1/8	.099	.174	L-184	1	7/16	3/8	1 1/2	.41	.603
L-192	5/8	3/16	1 1/8	1 1/4	.10	.091	L-220	1/2	1/2	3/4	2 9/16	.435	.464
+L-10	3/8	3/8	3/8	1 3/16	.105	.243	L-241	1/2	1/2	1	1 3/4	.438	.428
L-238	1/2	7/16	1/2	1	.11	.23	L-266	3/4	3/4	3/8	1 1/4	.44	.84

+ preferred core sizes: These cores should be used wherever possible in designing new transformers. They are subject to maximum discount regardless of quantity ordered. See selling policy 46-700.

*pg 20*

catalog number	dimensions in inches				relative power hand'l'g capac'y	weight: pounds	catalog number	dimensions in inches				relative power hand'l'g capac'y	weight: pounds
	strip width	build up	wind-down width	wind-down length				strip width	build up	wind-down width	wind-down length		
	D	E	F	G			D	E	F	G			
<b>2 mil series L</b>						<b>2 mil series L</b>							
L-236	1	3/8	5/8	1 15/16	.453	.57	L-84	3/4	3/4	1 15/16	2 1/2	1.32	1.26
L-243	1	1 15/32	5/8	1 1/16	.458	.662	L-157	3/8	7/8	1	1 3/4	1.341	1.548
L-127	3/4	3/4	3/4	1 1/8	.475	.844	L-303	1 3/8	1 9/32	3/4	2 5/16	1.42	1.56
L-154	3/4	3/8	3/4	2 1/4	.475	.481	L-99	1	5/8	1 15/16	2 1/2	1.465	1.338
+L-19	1	1/2	5/8	1 9/16	.489	.724	L-201	1 1/2	1	5/8	1 9/16	1.465	2.76
L-204	1	5/8	5/8	1 1/4	.489	.87	L-197	1 1/4	9/16	5/8	3 1/2	1.537	1.716
L-174	1	7/8	1/2	1 1/8	.493	1.278	L-31	2	9/8	1 1/16	1 3/4	1.959	1.29
L-200	1/2	3/8	1 1/8	2 3/8	.504	.374	L-177	7/8	9/16	1 1/8	2 7/8	1.993	1.168
L-92	1/2	1/2	1 3/16	1 3/4	.52	.485	L-259	3/4	3/4	1	3	1.669	1.42
L-271	7/8	5/8	5/8	1 9/16	.534	.837	L-47	1	1	3/4	2 5/16	1.734	2.245
L-122	3/4	3/4	13/16	1 3/16	.543	.88	L-120	1	3/4	1 5/16	2 1/2	1.758	1.68
L-244	3/4	1/2	3/4	1 15/16	.544	.629	L-128	1 1/8	1 1/16	1 5/16	2 1/2	1.813	1.835
L-21	3/4	3/8	5/8	1 15/16	.568	.81	L-100	1	5/8	1	3	1.875	1.51
L-91	1/2	1/2	1 9/16	2 1/2	.585	.51	L-175	5/8	1	1	3	1.875	1.695
L-112	1	1/2	1 1/16	1 3/4	.602	.785	L-133	1	13/16	1 5/16	2 1/2	1.903	1.862
+L-20	1	5/8	5/8	1 9/16	.611	.965	L-277	1	1 9/16	1 5/16	2 1/2	1.91	1.84
L-155	1	7/16	5/8	2 1/4	.614	.743	L-172	1	5/8	1 1/4	2 1/2	1.953	1.423
L-245	1	1/2	7/8	1 1/2	.657	.764	L-252	1 1/32	1 9/32	1 1/8	2 7/8	1.981	1.46
L-288	7/8	1/2	1/2	3	.657	.904	+L-25	1	7/8	1 5/16	2 1/2	2.05	2.04
L-196	1 1/8	1/2	7/16	2 3/4	.677	1.082	L-49	1 1/8	2 5/32	1 5/16	2 1/2	2.06	1.985
L-149	1	1/2	1/2	2 3/4	.688	.965	L-251	1 1/8	2 1/32	1	2 7/8	2.122	1.74
L-296	1/2	1/2	1 1/4	2 1/4	.703	.514	L-95	1	5/8	1	3 1/2	2.188	1.665
L-85	1	7/16	7/8	1 1/8	.716	.915	L-188	1 3/8	7/8	1 3/16	2 1/4	2.198	2.59
+L-64	1 1/8	1/2	7/16	3	.738	1.142	L-60	1 1/2	1/2	3/4	4	2.252	2.02
L-239	3/4	3/8	1 1/8	2 3/8	.751	.551	L-110	1 1/8	7/8	1 5/16	2 1/2	2.305	2.295
+L-22	1	5/8	5/8	1 15/16	.757	1.08	L-102	1	1	1 5/16	2 1/2	2.343	2.43
L-65	1	7/8	1 3/16	1 3/4	.781	.645	L-150	7/8	7/8	1 13/16	1 3/4	2.429	1.839
L-214	1 1/8	5/8	5/8	1 15/16	.85	1.22	L-46	1 1/8	7/8	1 5/16	2 1/16	2.478	2.38
L-186	1	3/8	1 5/16	2 1/2	.878	.729	L-93	1	5/8	1	4	2.50	1.80
L-38	3/4	3/8	3/4	2 1/2	.88	.956	L-106	2 1/2	1 9/32	3/4	2 5/16	2.576	2.86
L-44	3/4	5/8	3/4	2 9/16	.902	.983	L-212	1 1/4	1 1/4	3/4	2 5/16	2.73	3.82
L-228	1	5/8	3/4	1 15/16	.908	1.12	+L-248	1 1/8	3/4	1 1/8	2 7/8	2.731	2.11
+L-23	1 1/4	5/8	5/8	1 15/16	.945	1.352	L-170	1 1/8	5/8	1 1/4	3 3/16	2.802	1.85
L-108	3/4	3/4	3/4	2 1/4	.95	1.14	L-179	1 1/4	1 9/16	1 1/4	2 1/4	2.855	2.35
L-182	3/4	3/4	3/4	2 5/16	.976	1.16	L-73	1	7/8	1 5/16	3 1/2	2.87	2.48
L-258	3/4	7/16	1	3	.984	.74	L-103	1 1/4	1	1 5/16	2 1/2	2.928	3.04
L-191	1	1/2	7/8	2 1/4	.986	.944	L-53	1 3/8	7/8	1 5/16	2 1/16	3.029	2.92
L-209	3/4	7/16	1 3/16	2 9/16	.999	.701	L-77	1 3/4	3/4	1 1/8	3	3.165	2.42
L-178	1 1/2	1 1/16	5/8	1 9/16	1.007	1.645	L-189	1 3/8	2 5/32	1 1/8	2 1/16	3.196	2.985
L-165	1 1/4	9/16	5/8	2 5/16	1.015	1.292	L-81	1 1/8	1	1	3	3.375	3.05
+L-24	1	5/8	3/4	2 5/16	1.084	1.22	L-61	1 1/2	2 9/32	1 5/16	2 1/16	3.422	3.33
L-145	1 1/4	5/8	2 9/32	1 9/16	1.106	1.307	L-140	1 3/8	7/8	1	2 7/8	3.459	3.06
L-139	7/8	5/8	1 3/16	1 3/4	1.138	1.05	L-249	1 1/8	3/4	1 3/8	3	3.483	2.26
L-48	1 1/2	1/4	1 3/4	1 3/4	1.148	.70	L-111	1 3/4	7/8	1 5/16	2 1/2	3.588	3.58
L-74	7/8	9/16	1 5/16	2 1/2	1.153	1.03	L-35	1 1/4	1	1	3	3.75	3.39
L-187	1 3/8	9/16	1/2	3	1.161	1.644	+L-98	1	5/8	2	3	3.75	1.82
L-195	1 3/4	5/8	1/2	3	1.173	1.692	L-164	1	1	1 1/4	3	3.75	2.84
L-173	3/4	3/8	1	2 9/16	1.202	1.03	L-115	1 3/4	3/4	1	3	3.939	3.31
L-194	1 1/4	9/16	3/4	2 5/16	1.218	1.345	L-70	1 3/8	5/8	1 9/16	3 1/2	3.945	2.42
L-119	1	5/8	1 3/16	2 1/2	1.27	1.31	L-101	1 3/4	2 9/32	1 5/16	2 1/16	3.994	3.88

+ Preferred core sizes: These cores should be used wherever possible in designing new transformers. They are subject to maximum discount regardless of quantity ordered. See selling policy 46-700.

pg 21

catalog number	dimensions in inches				relative power handl'g capac'y	weight: pounds	catalog number	dimensions in inches				relative power handl'g capac'y	weight: pounds
	strip width	build up	wind-down width F	wind-down length G				strip width	build up	wind-down width F	wind-down length G		
	D	E	F	G			D	E	F	G			
<b>2 mil series L</b>													
L-27	2	7/8	1 5/16	2 1/2	4.10	4.08	L-180	1 5/8	1 9/16	1 13/16	4 7/8	22.42	11.27
L-118	1 1/4	1 5/16	1 7/16	2 1/2	4.208	3.085	L-56	1 5/8	1 1/2	2	4 1 1/16	22.859	10.78
L-279	1 1/2	7/8	1 1/16	3 1/16	4.268	3.48	L-237	2 1/2	1 3/8	1 3/8	3 3/8	24.978	18.65
L-226	1 3/4	5/8	1 5/16	4 1/4	4.356	3.30	L-276	1 1/2	1 1/2	3	4	27.00	10.14
L-113	1 1/4	1 1/4	1 1/4	2 1/4	4.397	4.16	L-125	2	1 3/8	2	5	27.50	12.30
†L-54	2	3/4	3/4	4	4.50	4.325	L-225	2	1 1/2	2	4 1 1/16	28.128	13.30
L-130	1 1/2	1	1	3	4.50	4.06	L-224	2	1 1/2	2	5	30.00	13.65
L-146	1 1/4	1 1/4	3/4	4	4.688	5.125	L-246	2 1/2	2	1 1/2	5	37.50	23.50
L-104	1 1/4	1 1/4	1	3	4.689	4.55	L-263	2 3/4	2 5/8	1 3/8	3 3/8	38.463	32.90
L-206	1 3/8	3/4	1 5/16	3 1/2	4.736	3.01	L-264	2	1 3/8	2 3/4	6	45.378	14.80
L-36	1 1/4	1	1 3/8	3	5.157	3.62	L-278	2	2 1/2	2	4 1 1/16	46.88	25.85
L-160	1 1/4	1 1/8	1 3/16	3 3/16	5.324	4.16	L-297	3	2	1 3/4	4 9/16	48.00	27.60
L-158	1 1/4	1 3/16	7/8	4 1/8	5.358	4.93	L-285	2 1/2	1 3/8	2 1/4	9 13/16	104.00	34.10
L-213	1 5/8	1	1 1/8	3	5.484	4.50	L-262	1 1/2	2 1/2	2 3/4	11 1/4	108.00	32.90
L-183	1 1/4	1 1/8	1 1/4	3 3/16	5.605	4.25	L-289	3 1/8	1 15/16	2 1/2	8 1/16	121.00	39.70
L-105	1 1/2	1 1/4	1	3	5.625	5.48	L-310	4 1/2	1 1/2	3	8 3/4	177.00	46.25
L-223	1 3/4	1 3/16	1 3/8	3	5.862	3.91	L-313	3	3	3 1/2	14 1/2	457.00	97.10
L-29	1 3/4	1 1/8	1	3	5.907	5.54	L-302	3 1/8	4 9/16	6	17 3/4	1385.00	195.00
L-59	2	1	1	3	6.00	5.25	L-301	6 1/4	4 3/16	6	17 3/4	2790.00	390.00
L-148	1 3/4	3/4	1 5/16	3 1/2	6.031	3.84							
L-205	2	1	1 5/16	2 1/2	6.56	5.24							
L-144	2	1 1/8	1	3	6.75	6.33							
L-275	1	3/4	3	3	6.75	2.60							
L-52	1 5/8	7/8	1 15/16	2 1 1/16	7.403	3.31							
L-117	2	1	1 3/16	3 3/8	7.425	5.72							
L-87	1 1/8	1 5/8	1 3/8	3	7.542	6.19							
L-215	2	3/4	1 1/4	4 3/16	7.853	4.80							
L-168	1	1	2	4	8.00	3.67							
L-68	2	1	1 3/8	3	8.25	5.78							
L-126	2	1 1/4	1 1/8	3	8.439	7.41							
L-260	2	1	1 1/4	3 1/2	8.75	6.12							
L-89	2	1 1/4	1 1/4	3	9.375	7.58							
L-63	3/4	1 1/2	3	3	10.125	4.48							
L-72	2	1 1/4	1 3/8	3	10.314	7.73							
L-221	1 1/2	1 1/2	1 5/16	3 1/2	10.332	7.88							
L-299	2	1	1 1/4	4 1/4	10.60	6.85							
L-176	1 1/2	1 3/8	1 1/4	4 1/4	10.961	7.75							
L-199	1 5/8	1 1/4	1 5/16	4 3/8	12.326	7.85							
L-171	1	1 1/4	2	5	12.50	5.44							
L-198	2	1 1/4	1 1/4	4 3/16	13.088	9.20							
L-242	2	1 1/4	1 1/4	4 1/4	13.281	9.04							
L-193	2 1/2	1 1/4	1	4 1/2	14.063	11.40							
L-185	2	1 1/2	1 9/16	3 9/16	16.692	11.00							
L-141	1 1/2	1 1/2	1 1/2	5	16.875	9.50							
L-233	2	1 1/4	1 1/2	4 1/2	16.875	9.66							
L-55	1 5/8	1 1/2	1 3/4	4 1/16	17.333	9.50							
L-218	1 1/4	1 1/4	2	6	18.756	7.56							
L-67	1 5/8	1 1/2	1 3/4	4 1 1/16	20.004	10.49							
L-222	2	1 1/2	1 1/2	4 1/2	20.25	12.30							
L-129	2	1 1/4	1 13/16	4 3/8	22.084	10.30							

† preferred core sizes: These cores should be used wherever possible in designing new transformers. They are subject to maximum discount regardless of quantity ordered. See selling policy 46-700.

pg. 22

catalog number	dimensions in inches				relative power handl'g capacity	weight: pounds
	strip width	build up	wind-down width	wind-down length		
	D	E	F	G		

catalog number	dimensions in inches				relative power handl'g capacity	weight: pounds
	strip width	build up	wind-down width	wind-down length		
	D	E	F	G		

1 mil series M

<del>M-3</del>	<del>1/4</del>	<del>3/8</del>	<del>1/4</del>	<del>1/2</del>	<del>.004</del>	<del>.014</del>
<del>M-1</del>	<del>1/4</del>	<del>3/16</del>	<del>1/4</del>	<del>5/8</del>	<del>.008</del>	<del>.027</del>
<del>M-21</del>	<del>1/4</del>	<del>1/4</del>	<del>1/4</del>	<del>1/2</del>	<del>.008</del>	<del>.033</del>
<del>M-10</del>	<del>1/4</del>	<del>1/4</del>	<del>1/4</del>	<del>5/8</del>	<del>.01</del>	<del>.036</del>
<del>M-6</del>	<del>3/8</del>	<del>3/16</del>	<del>1/4</del>	<del>5/8</del>	<del>.011</del>	<del>.038</del>
<del>M-2</del>	<del>1/2</del>	<del>1/4</del>	<del>1/4</del>	<del>7/8</del>	<del>.014</del>	<del>.043</del>
<del>M-4</del>	<del>3/8</del>	<del>1/4</del>	<del>1/4</del>	<del>7/8</del>	<del>.021</del>	<del>.068</del>
<del>M-8</del>	<del>3/8</del>	<del>7/32</del>	<del>5/16</del>	<del>1</del>	<del>.026</del>	<del>.064</del>
<del>M-7</del>	<del>1/2</del>	<del>1/4</del>	<del>1/4</del>	<del>7/8</del>	<del>.027</del>	<del>.088</del>
<del>M-34</del>	<del>3/8</del>	<del>1/4</del>	<del>1/2</del>	<del>1 1/16</del>	<del>.062</del>	<del>.099</del>
<del>M-5</del>	<del>3/8</del>	<del>3/8</del>	<del>3/8</del>	<del>1 3/16</del>	<del>.063</del>	<del>.143</del>
<del>M-30</del>	<del>3/8</del>	<del>3/8</del>	<del>7/16</del>	<del>1 1/4</del>	<del>.07</del>	<del>.143</del>
<del>M-37</del>	<del>3/8</del>	<del>3/8</del>	<del>1/2</del>	<del>1 1/8</del>	<del>.08</del>	<del>.147</del>
<del>M-70</del>	<del>3/8</del>	<del>3/16</del>	<del>1/2</del>	<del>1 3/8</del>	<del>.081</del>	<del>.114</del>
<del>M-15</del>	<del>1/2</del>	<del>3/8</del>	<del>3/8</del>	<del>1 3/16</del>	<del>.084</del>	<del>.193</del>
<del>M-11</del>	<del>5/8</del>	<del>1/4</del>	<del>1/2</del>	<del>1 1/8</del>	<del>.088</del>	<del>.155</del>
<del>M-33</del>	<del>3/8</del>	<del>1/4</del>	<del>7/8</del>	<del>1 1/4</del>	<del>.103</del>	<del>.12</del>
<del>M-42</del>	<del>5/8</del>	<del>3/8</del>	<del>3/8</del>	<del>1 3/16</del>	<del>.105</del>	<del>.239</del>
<del>M-24</del>	<del>1/2</del>	<del>7/16</del>	<del>1/2</del>	<del>1 1/8</del>	<del>.124</del>	<del>.24</del>
<del>M-16</del>	<del>3/4</del>	<del>3/8</del>	<del>3/4</del>	<del>1 1/8</del>	<del>.125</del>	<del>.285</del>
<del>M-36</del>	<del>1/2</del>	<del>7/16</del>	<del>9/16</del>	<del>1 1/8</del>	<del>.138</del>	<del>.246</del>
<del>M-61</del>	<del>1/2</del>	<del>1/2</del>	<del>1/2</del>	<del>1 1/4</del>	<del>.156</del>	<del>.301</del>
<del>M-71</del>	<del>5/8</del>	<del>3/8</del>	<del>1/2</del>	<del>1 3/8</del>	<del>.161</del>	<del>.26</del>
<del>M-55</del>	<del>1/2</del>	<del>7/16</del>	<del>1/2</del>	<del>1 1/16</del>	<del>.172</del>	<del>.286</del>
<del>M-53</del>	<del>1/2</del>	<del>3/8</del>	<del>5/8</del>	<del>1 1/8</del>	<del>.192</del>	<del>.257</del>
<del>M-12</del>	<del>1/2</del>	<del>1/2</del>	<del>1/2</del>	<del>1 1/16</del>	<del>.195</del>	<del>.341</del>
<del>M-49</del>	<del>3/4</del>	<del>7/16</del>	<del>1/2</del>	<del>1 1/4</del>	<del>.205</del>	<del>.378</del>
<del>M-43</del>	<del>1/2</del>	<del>7/16</del>	<del>5/8</del>	<del>1 1/16</del>	<del>.214</del>	<del>.299</del>
<del>M-22</del>	<del>5/8</del>	<del>1/2</del>	<del>1/2</del>	<del>1 1/16</del>	<del>.245</del>	<del>.425</del>
<del>M-31</del>	<del>1</del>	<del>7/16</del>	<del>1/2</del>	<del>1 1/8</del>	<del>.246</del>	<del>.485</del>
<del>M-40</del>	<del>3/4</del>	<del>1/2</del>	<del>5/8</del>	<del>1 1/8</del>	<del>.263</del>	<del>.452</del>
<del>M-60</del>	<del>5/8</del>	<del>3/8</del>	<del>1 3/16</del>	<del>1 7/16</del>	<del>.273</del>	<del>.30</del>
<del>M-13</del>	<del>3/4</del>	<del>1/2</del>	<del>1/2</del>	<del>1 1/16</del>	<del>.294</del>	<del>.508</del>
<del>M-19</del>	<del>1</del>	<del>1/2</del>	<del>1/2</del>	<del>1 1/16</del>	<del>.301</del>	<del>.681</del>
<del>M-56</del>	<del>3/4</del>	<del>1/2</del>	<del>5/8</del>	<del>1 15/16</del>	<del>.453</del>	<del>.60</del>
<del>M-45</del>	<del>3/4</del>	<del>3/4</del>	<del>3/4</del>	<del>1 1/8</del>	<del>.475</del>	<del>.816</del>
<del>M-14</del>	<del>1</del>	<del>1/2</del>	<del>5/8</del>	<del>1 1/16</del>	<del>.489</del>	<del>.711</del>
<del>M-48</del>	<del>3/4</del>	<del>1 1/16</del>	<del>5/8</del>	<del>1 1/16</del>	<del>.505</del>	<del>.81</del>
<del>M-38</del>	<del>7/8</del>	<del>3/8</del>	<del>2 9/32</del>	<del>1 25/32</del>	<del>.529</del>	<del>.545</del>
<del>M-44</del>	<del>1</del>	<del>5/8</del>	<del>5/8</del>	<del>1 3/8</del>	<del>.538</del>	<del>.89</del>
<del>M-67</del>	<del>3/4</del>	<del>1/2</del>	<del>3/4</del>	<del>1 15/16</del>	<del>.544</del>	<del>.632</del>
<del>M-9</del>	<del>3/4</del>	<del>5/8</del>	<del>5/8</del>	<del>1 15/16</del>	<del>.568</del>	<del>.795</del>
<del>M-65</del>	<del>1</del>	<del>1/2</del>	<del>1 1/16</del>	<del>1 3/4</del>	<del>.602</del>	<del>.77</del>
<del>M-39</del>	<del>1</del>	<del>5/8</del>	<del>5/8</del>	<del>1 1/16</del>	<del>.611</del>	<del>.948</del>
<del>M-64</del>	<del>3/4</del>	<del>9/16</del>	<del>3/4</del>	<del>1 15/16</del>	<del>.614</del>	<del>.742</del>
<del>M-62</del>	<del>3/4</del>	<del>3/8</del>	<del>3/4</del>	<del>1 15/16</del>	<del>.682</del>	<del>.832</del>
<del>M-27</del>	<del>1</del>	<del>7/16</del>	<del>7/8</del>	<del>1 7/8</del>	<del>.716</del>	<del>.915</del>
<del>M-23</del>	<del>1</del>	<del>5/8</del>	<del>5/8</del>	<del>1 15/16</del>	<del>.757</del>	<del>1.06</del>
<del>M-51</del>	<del>1 1/2</del>	<del>1 1/16</del>	<del>5/8</del>	<del>1 1/16</del>	<del>1.007</del>	<del>1.615</del>
<del>M-41</del>	<del>1 1/4</del>	<del>9/16</del>	<del>5/8</del>	<del>2 5/16</del>	<del>1.015</del>	<del>1.27</del>

1 mil series M

<del>M-52</del>	<del>1</del>	<del>5/8</del>	<del>3/4</del>	<del>2 5/16</del>	<del>1.084</del>	<del>1.198</del>
<del>M-35</del>	<del>1</del>	<del>1</del>	<del>5/8</del>	<del>1 15/16</del>	<del>1.211</del>	<del>1.985</del>
<del>M-20</del>	<del>1</del>	<del>7/8</del>	<del>1 5/16</del>	<del>2 1/2</del>	<del>2.05</del>	<del>2.00</del>
<del>M-54</del>	<del>1</del>	<del>1 1/8</del>	<del>1 5/16</del>	<del>2 1/16</del>	<del>2.173</del>	<del>2.55</del>
<del>M-50</del>	<del>3/4</del>	<del>1</del>	<del>1 1/8</del>	<del>2 7/8</del>	<del>2.427</del>	<del>1.99</del>
<del>M-66</del>	<del>1</del>	<del>3/4</del>	<del>1 1/8</del>	<del>2 7/8</del>	<del>2.427</del>	<del>1.85</del>
<del>M-59</del>	<del>1 3/4</del>	<del>9/16</del>	<del>1 3/8</del>	<del>3</del>	<del>4.059</del>	<del>2.47</del>
<del>M-47</del>	<del>1 1/2</del>	<del>1</del>	<del>1 1/8</del>	<del>2 7/8</del>	<del>4.853</del>	<del>3.99</del>
<del>M-57</del>	<del>1</del>	<del>1</del>	<del>1 1/2</del>	<del>3 3/8</del>	<del>5.063</del>	<del>3.08</del>
<del>M-28</del>	<del>1 1/8</del>	<del>1 3/8</del>	<del>1 3/8</del>	<del>3</del>	<del>7.542</del>	<del>6.05</del>
<del>M-58</del>	<del>2</del>	<del>7/8</del>	<del>1 1/16</del>	<del>3 1/2</del>	<del>8.036</del>	<del>5.16</del>
<del>M-25</del>	<del>3/4</del>	<del>1 1/2</del>	<del>3</del>	<del>3</del>	<del>10.25</del>	<del>4.48</del>

\* preferred core sizes: These cores should be used wherever possible in designing new transformers. They are subject to maximum discount regardless of quantity ordered. See selling policy 46-700.

catalog number	dimensions in inches				relative power hand'l'g cap'cy	weight: pounds	catalog number	dimensions in inches				relative power hand'l'g cap'cy	weight: pounds
	strip width	build up	wind-down width	wind-down length				strip width	build up	wind-down width	wind-down length		
	D	E	F	G			D	E	F	G			
<b>4 mil series Z</b>							<b>4 mil series Z</b>						
Z-164	1/4	1/8	1/4	1/2	.004	.014	+Z-147	3/4	3/8	1/2	15/16	.185	.327
+Z-568	1/4	1/8	1/4	5/8	.005	.015	Z-124	1	1/2	3/8	1	.188	.522
Z-152	1/2	1/8	1/4	1/2	.008	.027	+Z-555	1 1/8	3/8	3/8	13/16	.188	.439
+Z-2	3/8	3/16	1/4	5/8	.011	.038	Z-101	3/4	3/8	7/16	1 5/8	.20	.362
Z-127	3/8	13/64	1/4	5/8	.012	.043	Z-117	1 1/8	9/32	9/16	1 1/8	.20	.326
Z-110	3/8	1/4	1/4	5/8	.015	.056	+Z-381	7/8	7/16	3/8	17/16	.205	.465
+Z-549	1/2	3/16	1/4	5/8	.015	.052	Z-216	3/4	3/8	1/2	1 1/2	.212	.354
+Z-530	1/2	7/32	1/4	5/8	.018	.063	+Z-5	3/4	3/8	5/8	1 1/4	.220	.334
+Z-550	5/8	7/32	1/4	5/8	.021	.079	Z-80	1 1/8	5/16	9/16	1 1/8	.222	.369
Z-594	3/8	1/4	5/16	3/4	.022	.065	Z-19	3/4	5/16	5/8	19/16	.228	.306
+Z-569	3/8	1/4	5/16	7/8	.025	.071	Z-30	1	9/32	1/2	1 5/8	.229	.351
+Z-4	3/8	3/16	3/8	1	.026	.056	Z-131	3/4	13/32	5/8	1 1/4	.239	.372
Z-111	1/2	1/4	1/4	7/8	.027	.091	Z-102	3/4	3/8	1/2	1 3/4	.247	.389
Z-128	3/8	13/64	3/8	1	.029	.062	+Z-215	3/8	7/16	1/2	15/16	.251	.465
Z-177	3/8	3/8	3/8	5/8	.033	.136	Z-591	3/4	3/8	3/4	13/16	.251	.344
+Z-531	1/2	1/4	5/16	7/8	.034	.094	Z-165	3/4	7/16	5/16	2 1/2	.255	.51
Z-586	3/4	7/32	1/4	1	.041	.125	Z-50	5/8	1/2	5/8	15/16	.257	.413
+Z-551	5/8	1/4	5/16	7/8	.043	.118	Z-582	1 1/2	13/32	3/8	1 1/8	.257	.63
Z-89	3/8	1/4	3/8	1 1/4	.044	.094	Z-72	1	9/32	5/8	19/16	.275	.361
Z-532	1/2	9/32	5/16	1	.044	.119	+Z-556	1 1/8	3/8	1/2	15/16	.277	.491
+Z-112	1/2	1/4	3/8	1	.047	.106	+Z-408	7/8	7/16	7/16	1 1/16	.282	.525
+Z-382	5/8	1/4	3/8	1	.059	.133	Z-145	7/8	7/16	1/2	19/16	.298	.512
+Z-360	5/8	5/16	5/16	1	.061	.169	+Z-409	7/8	7/16	7/16	1 15/16	.30	.522
+Z-552	3/4	9/32	5/16	1	.066	.178	Z-58	5/8	5/8	5/8	1 1/4	.305	.543
+Z-1	1/2	1/4	1/2	1 1/8	.070	.122	Z-371	7/8	3/8	5/8	19/16	.32	.443
Z-77	1/2	1/4	1/2	1 1/8	.071	.126	+Z-376	1	7/16	7/16	1 1/16	.322	.599
Z-88	3/8	3/8	7/16	1 1/16	.074	.151	+Z-379	1	13/32	7/16	1 15/16	.343	.597
Z-129	3/8	17/64	1/2	1 1/8	.075	.131	Z-67	5/8	5/8	1 1/16	1 1/16	.353	.443
+Z-407	3/4	1/4	3/8	1 1/8	.08	.171	+Z-557	1 1/4	7/16	1/2	15/16	.358	.664
Z-251	1/2	5/16	7/16	1 1/16	.081	.16	Z-103	7/8	7/16	9/16	1 1/16	.363	.548
+Z-553	7/8	5/16	5/16	1	.085	.237	+Z-372	7/8	7/16	5/8	19/16	.373	.535
+Z-533	5/8	5/16	3/8	13/16	.087	.193	+Z-223	1	1/2	1/2	1 1/2	.375	.678
Z-87	5/8	1/4	1/2	1 1/8	.088	.153	Z-148	1 1/4	5/16	5/8	19/16	.381	.509
Z-587	7/8	1/4	5/16	1 1/16	.089	.213	Z-31	1 1/4	23/64	5/8	19/16	.395	.543
+Z-380	7/8	1/4	3/8	1 1/8	.092	.20	Z-104	7/8	7/16	5/8	1 15/16	.463	.606
Z-173	1	1/4	3/8	1	.094	.213	Z-132	1	25/64	5/8	1 15/16	.473	.605
Z-100	5/8	5/16	7/16	13/16	.101	.20	Z-353	1	7/16	5/8	1 3/4	.478	.655
Z-94	1/2	5/16	7/16	19/16	.106	.189	Z-116	1/2	1/2	7/8	2 1/4	.493	.472
+Z-3	3/4	1/4	1/2	1 1/8	.106	.183	Z-125	1 1/8	3/8	5/8	1 15/16	.511	.648
Z-130	3/4	17/64	1/2	1 1/8	.113	.196	Z-57	7/8	9/16	5/8	1 1/16	.52	.768
Z-149	3/8	5/16	5/8	19/16	.114	.157	Z-581	1 1/8	9/16	1 1/16	1 1/4	.544	.869
+Z-554	7/8	5/16	3/8	13/16	.121	.271	+Z-558	1 1/2	1/2	1/2	1 1/2	.563	1.01
Z-17	1/2	7/16	1/2	1 1/8	.124	.245	Z-139	1 1/4	3/8	5/8	1 15/16	.568	.72
+Z-361	3/4	3/8	3/8	13/16	.125	.292	+Z-369	1 1/8	7/16	1 1/16	1 3/4	.592	.75
Z-146	5/8	5/16	1/2	1 1/16	.129	.218	+Z-411	7/8	7/16	5/8	2 1/2	.598	.704
Z-304	5/8	5/16	1/2	1 1/2	.147	.236	+Z-224	1 1/8	9/16	9/16	1 1 1/16	.599	.97
Z-64	3/8	1/4	3/8	19/16	.153	.196	Z-105	1	1/2	5/8	19/16	.606	.817
Z-144	5/8	3/8	1/2	1 1/16	.154	.273	Z-126	1	5/8	5/8	19/16	.611	.966
Z-153	1	1/4	1/2	1 1/4	.156	.259	Z-123	1/2	1	1	2 9/16	.641	.526
Z-109	5/8	1/2	7/16	1 3/16	.163	.365	Z-114	1	1/2	3/4	1 13/16	.68	.861

† preferred core sizes: These cores should be used wherever possible in designing new transformers. They are subject to maximum discount regardless of quantity ordered. See selling policy 46-700.

*Pg 24*

catalog number	dimensions in inches				relative power handl'g capac'y	weight: pounds
	strip width	build up	wind-down width	wind-down length		
	D	E	F	G		
<b>4 mil series Z</b>						
Z-163	1 1/4	3/8	3/4	1 15/16	.682	.755
Z-119	1	3/8	5/8	1 3/4	.684	1.023
Z-589	1 1/4	15/32	5/8	1 15/16	.709	.94
Z-150	7/8	7/16	7/8	2 1/4	.752	.705
+Z-410	1 1/8	7/16	5/8	2 1/2	.77	.905
Z-15	1	3/8	1 3/16	1 3/4	.781	.65
Z-141	1 1/8	9/16	1 1/16	1 13/16	.788	1.048
Z-154	1 1/2	3/8	3/4	1 7/8	.791	.882
Z-151	1 3/8	3/8	5/8	2 1/2	.808	.923
Z-160	1 1/4	3/8	3/4	2 3/16	.814	.824
+Z-370	1 1/8	1/2	3/4	1 15/16	.817	.955
Z-106	1	1/2	5/8	2 3/8	.822	.974
Z-137	1	13/32	1 3/16	1 3/4	.844	.615
Z-68	1 1/8	5/8	5/8	1 15/16	.850	1.219
Z-595	1	7/16	7/8	2 1/2	.862	.803
+Z-559	1 5/8	9/16	9/16	1 11/16	.866	1.39
Z-155	1 1/2	3/8	5/8	2 1/2	.88	1.008
Z-121	1 1/8	9/16	3/4	1 15/16	.918	1.10
+Z-413	1 1/8	17/32	5/8	2 1/2	.933	1.14
+Z-213	1 1/4	5/8	5/8	1 15/16	.945	1.35
Z-140	1 1/8	9/16	1 3/16	1 15/16	.994	1.123
+Z-412	1 1/4	17/32	5/8	2 1/2	1.038	1.27
+Z-540	1 1/8	9/16	1 3/16	2 1/8	1.09	1.16
Z-107	1 1/8	9/16	3/4	2 5/16	1.096	1.205
Z-60	7/8	5/8	1 3/16	1 11/16	1.097	1.03
Z-90	1 1/4	5/8	5/8	2 5/16	1.128	1.281
Z-86	7/8	7/16	1	3	1.146	.87
Z-10	1 1/8	5/8	1	1 3/4	1.23	1.28
+Z-415	1 1/4	5/8	5/8	2 3/8	1.281	1.60
+Z-534	1 3/8	1 1/16	1 1/16	2 1/16	1.342	1.74
+Z-414	1 3/8	5/8	5/8	2 5/8	1.41	1.76
Z-27	1 3/8	1 1/32	3/4	2 5/16	1.417	.997
+Z-560	1 7/8	5/8	5/8	1 15/16	1.42	2.02
Z-354	1 1/4	9/16	7/8	2 5/16	1.422	1.38
+Z-541	1 1/4	5/8	7/8	2 5/16	1.579	1.57
Z-23	7/8	9/16	1 1/8	2 7/8	1.593	1.166
Z-108	1 1/4	5/8	3/4	2 3/4	1.612	1.70
Z-590	1 1/2	1 1/32	3/4	2 1/2	1.67	1.80
Z-142	1 1/4	5/8	1 3/16	2 1/2	1.83	1.67
Z-84	1	2 9/32	1 5/16	2 1/4	1.91	1.50
+Z-417	1 3/8	1 1/16	1 1/16	3	1.953	2.184
+Z-561	2	1 1/16	1 1/16	2 1/16	1.953	2.53
Z-7	1 1/2	5/8	1	2 1/8	1.993	1.859
Z-134	1 1/2	4 1/64	1	2 1/8	2.044	1.928
Z-62	1 1/4	9/16	1 1/8	2 7/8	2.274	1.686
+Z-416	1 5/8	1 1/16	1 1/16	3	2.307	2.585
+Z-214	1 1/2	3/4	3/4	2 15/16	2.479	2.30
Z-24	1 3/8	9/16	1 1/8	2 7/8	2.501	1.833
+Z-562	2 1/4	3/4	3/4	2 5/16	2.927	3.46
+Z-419	1 1/2	3/4	3/4	3 1/2	2.954	2.96

catalog number	dimensions in inches				relative power handl'g capac'y	weight: pounds
	strip width	build up	wind-down width	wind-down length		
	D	E	F	G		
<b>4 mil series Z</b>						
Z-16	1 1/2	1 1/16	1	3	3.096	2.54
+Z-542	1 5/8	3/4	1	2 1/16	3.123	2.80
Z-135	1 1/2	4 5/64	1	3	3.165	2.61
+Z-418	1 7/8	3/4	3/4	3 1/2	3.693	3.71
Z-122	1 1/4	3/4	1 3/16	4 1/4	3.736	2.91
+Z-563	2 1/2	1 3/16	1 3/16	2 1/2	4.12	4.51
+Z-543	1 3/4	1 3/16	1 1/8	2 7/8	4.597	3.64
Z-592	1 1/4	3/4	2	3	5.64	2.82
Z-13	1 3/4	1 3/16	1 3/8	3	5.862	3.90
+Z-564	2 1/2	1 9/16	1 5/16	2 1 1/16	5.90	5.80
Z-136	1 3/4	5 9/64	1 3/8	3	5.976	3.99
+Z-544	1 3/4	7/8	1 9/16	3 1/2	7.032	4.61
+Z-545	2	1	1 3/8	3 5/8	9.969	6.41
+Z-546	2 1/4	1	1 1/2	4	13.50	7.77
+Z-547	2 1/2	1 1/8	1 3/8	4 3/16	19.143	10.42

+ preferred core sizes: These cores should be used wherever possible in designing new transformers. They are subject to maximum discount regardless of quantity ordered. See selling policy 46-700.



catalog number	dimensions in inches				relative power handl'g capac'y	weight pounds	catalog number	dimensions in inches				relative power handl'g capac'y	weight pounds
	strip width	build up	win-dow width	win-dow length				strip width	build up	win-dow width	win-dow length		
	D	E	F	G			D	E	F	G			
<b>12 mil series TA</b>							<b>12 mil series TA</b>						
TA-21	1	½	½	1½	.375	1.15	TA-53	5	3¾	3¾	9	633.00	299.00
TA-2	¾	¾	1¼	2½	.877	1.174	TA-28	4	5	4¼	8½	723.00	350.00
TA-10	1¼	¾	1⅞	2⅞	1.107	2.65	TA-43	4	5	5¼	8½	893.00	375.00
TA-9	1¼	¾	¾	1⅞	1.237	2.42	TA-38	6	7¼	3¾	9	1419.00	336.00
TA-11	1½	¾	¾	2¼	1.662	3.011							
TA-7	1½	½	1¼	2¾	1.848	2.21							
TA-18	1¼	¾	1¼	2½	2.932	3.899							
TA-42	2½	1	¾	1⅞	3.02	8.56							
TA-19	1½	¾	1¼	2½	3.515	4.679							
TA-37	2¼	1	¾	2¾	3.68	8.84							
TA-20	1¾	¾	1¼	2½	4.102	5.43							
TA-5	1½	1	1¼	2½	5.157	6.74							
TA-12	2	1	1	3	6.00	9.22							
TA-4	1¾	1¼	1¾	3	7.092	9.15							
+TA-1	1¾	1	1¾	3	7.218	8.75							
TA-3	1¾	1	1¾	3¾	9.323	9.94							
TA-17	1¾	1	1¾	3¾	11.869	10.651							
TA-13	1¾	1	1½	5⅞	12.341	10.98							
TA-41	2¾	1⅞	1¾	4⅞	16.50	19.20							
TA-16	1¾	1¾	2½	2¾	18.092	19.805							
+TA-6	2½	1½	1¾	3¾	19.979	23.75							
TA-23	1¾	1¾	1½	5⅞	23.138	24.10							
TA-53	2½	1¼	1¾	4½	24.70	21.60							
TA-22	2½	1¾	1¾	3¾	24.978	32.00							
TA-651	2½	1½	1¾	4½	28.90	26.50							
TA-34	3	1⅞	1¼	5⅞	29.10	33.00							
TA-27	2¾	1½	2	5⅞	34.10	23.60							
TA-32	2¾	1¼	2	5½	36.10	26.00							
TA-668	2¼	2	2	5¼	47.30	39.10							
TA-652	3½	1¾	2½	4¾	53.70	43.90							
TA-667	3½	1¾	2¼	4⅞	62.50	49.50							
TA-39	3	1¾	2¼	6¾	75.30	50.20							
TA-653	3¾	2	2¾	5¾	82.00	60.80							
TA-659	3¾	2½	2¾	5½	107.00	74.90							
TA-654	3¾	2¼	2¾	5½	114.00	80.90							
TA-661	2¾	2¾	3⅞	6½	122.00	65.10							
TA-666	3¾	2½	2¾	5½	126.00	93.00							
TA-47	2	2¾	2½	11	129.00	81.70							
TA-40	2⅞	2¼	2¾	7½	133.40	73.20							
TA-655	4	2¾	3½	6½	211.00	127.00							
TA-45	4	3¾	2¾	5¾	214.00	158.00							
TA-665	2½	2	4	12	240.00	80.60							
TA-658	3¾	2½	3⅞	6¾	246.00	118.00							
TA-35	3½	3½	2½	8½	260.00	167.60							
TA-663	4	2¾	3¾	8	330.00	150.40							
TA-44	4	3	3¾	8	360.00	168.00							
TA-664	3¾	2	4	12	360.00	120.70							
TA-650	2¼	2⅞	5	13½	437.00	126.00							
TA-656	4	3¾	3¾	8	450.00	225.20							
TA-662	3¾	4⅞	4¼	8¾	618.00	283.00							

† preferred core sizes: These cores should be used wherever possible in designing new transformers. They are subject to maximum discount regardless of quantity ordered. See selling policy 46-700.

pg 26

catalog number	dimensions in inches				relative power hand'l'g capac'y	weight: pounds
	strip width	build up	wind-down width	wind-down length		
	D	E	F	G		

catalog number	dimensions in inches				relative power hand'l'g capac'y	weight: pounds
	strip width	build up	wind-down width	wind-down length		
	D	E	F	G		

**4 mil series TH**

**4 mil series TH**

TH-112	¼	¼	5/16	1	.02	.082
TH-105	¾	¼	5/16	1	.029	.123
+TH-97	¾	¼	7/16	1	.041	.14
TH-656	¾	¼	½	1½	.069	.17
TH-43	¾	¾	½	1½	.079	.246
+TH-69	½	¾	7/16	1	.082	.309
+TH-96	¾	5/16	7/16	1½	.115	.39
TH-49	5/8	¾	½	1½	.131	.42
TH-110	¾	¾	½	1¼	.146	.432
TH-52	¾	¾	½	1½	.158	.56
+TH-25	½	¾	5/8	1½	.191	.435
TH-26	½	½	5/8	15/16	.204	.544
+TH-55	¾	¾	¾	13/16	.209	.495
TH-83	¾	½	½	1½	.211	.736
+TH-74	¾	¾	½	19/16	.22	.675
+TH-41	¾	½	5/8	1¾	.321	.856
TH-116	1	½	½	1¾	.343	.645
+TH-56	¾	½	¾	19/16	.365	.911
TH-62	1	½	½	1½	.375	1.176
TH-89	½	½	¾	2	.376	.725
TH-84	5/8	½	¾	15/8	.381	.814
+TH-78	1	½	½	19/16	.39	1.15
TH-87	¾	½	11/16	1½	.419	.953
TH-48	7/8	½	¾	1½	.445	1.05
TH-67	5/8	½	¾	2	.47	.905
+TH-77	1	½	5/8	19/16	.488	1.214
TH-123	1	½	5/8	19/16	.488	1.21
+TH-66	7/8	½	11/16	1½	.489	1.11
TH-40	¾	¾	7/8	1½	.554	1.553
+TH-65	1	½	11/16	1½	.559	1.27
+TH-31	¾	¾	13/16	1¼	.571	1.52
TH-99	13/16	½	¾	19/16	.671	1.62
TH-88	1	½	11/16	21/16	.695	1.418
TH-19	5/8	¾	1½	2	.702	.825
TH-98	1½	½	5/8	19/16	.732	1.762
+TH-53	¾	2¼	7/16	1	.738	.28
TH-7	¾	¾	¾	113/16	.742	1.50
+TH-90	1	½	¾	2	.75	1.45
TH-80	1	¾	11/16	1½	.838	2.14
TH-109	1	½	¾	2¼	.843	1.474
TH-18	¾	¾	1½	2	.844	.987
TH-662	1	¾	¾	1½	.845	1.92
TH-47	1½	5/8	¾	15/16	.85	2.02
TH-12	¾	¾	1¾	25/16	.892	1.212
TH-28	¾	1	13/16	1½	.913	2.201
+TH-30	1¼	5/8	¾	15/16	.945	2.25
TH-29	1½	5/8	13/16	11/16	.963	2.10
TH-20	7/8	¾	2	1.16	.984	1.16
TH-27	¾	¾	7/8	2	.986	.495
TH-136	1¼	9/16	11/16	21/16	.996	1.98

TH-51	1	1	13/16	1¼	1.015	3.105
TH-5	1¼	13/16	13/16	1¼	1.03	2.626
+TH-58	1¼	5/8	11/16	21/16	1.107	2.34
TH-107	1½	5/8	7/8	113/16	1.114	2.07
TH-131	1¼	5/8	¾	2	1.17	2.28
TH-32	¾	¾	15/16	2¼	1.188	2.049
TH-9	¾	7/16	1¼	2½	1.195	1.422
+TH-61	1¼	5/8	7/8	113/16	1.237	2.37
TH-17	1	7/16	1½	2	1.312	1.612
TH-95	1	¾	1	1¾	1.312	2.509
TH-42	1¼	¾	13/16	2	1.524	3.13
TH-102	1¼	9/16	1½	115/16	1.534	2.25
TH-11	1	½	1¼	2½	1.562	1.902
TH-94	1	¾	1¼	1¾	1.641	2.696
TH-71	1½	¾	7/8	2¼	1.662	2.95
+TH-33	1	¾	1	2¼	1.687	2.71
TH-664	2½	9/16	¾	1¾	1.69	3.32
+TH-6	¾	¾	1¼	2½	1.76	2.29
TH-10	1½	½	1¼	2½	1.76	2.14
TH-85	1	¾	1	2¾	1.781	2.87
TH-132	1¼	13/16	15/16	17/8	1.79	3.33
TH-46	1¼	7/8	7/8	17/8	1.794	3.70
TH-16	7/8	½	1¾	3	1.806	1.838
TH-60	¾	¾	1¼	25/8	1.848	2.374
TH-655	2	9/16	¾	17/8	1.85	3.08
+TH-70	1¼	7/8	13/16	17/8	1.921	3.79
TH-660	2½	5/8	¾	115/16	1.93	3.63
TH-59	1½	¾	¾	25/16	1.951	4.00
TH-659	1	1	13/16	2½	2.03	3.80
TH-118	1¼	¾	1	2¼	2.11	3.27
TH-117	1½	¾	7/8	3	2.217	3.22
+TH-91	7/8	7/8	1	3	2.298	3.33
TH-101	1¾	¾	1	2¼	2.319	3.60
TH-652	1¼	13/16	1¼	2½	2.32	2.90
TH-15	1½	½	1¾	3	2.322	2.624
+TH-35	1	¾	1¼	2½	2.345	3.05
TH-81	1¼	¾	1½	2¼	2.373	3.51
TH-667	1	7/8	1	2¾	2.40	3.32
TH-665	1	7/8	1¾	2½	2.46	3.16
TH-661	1¾	1	13/16	2¾	2.64	4.64
TH-666	1	7/8	1½	2¾	2.70	3.32
TH-13	1¼	9/16	1¾	3	2.901	3.066
TH-133	1¾	5/8	1¾	3	2.90	3.46
+TH-4	1¼	¾	1¼	2½	2.932	3.81
+TH-92	1	1	1	3	3.00	4.51
TH-135	1¼	1	15/32	2½	3.08	4.84
+TH-34	1	1	1¼	2½	3.125	4.39
TH-39	1½	1	15/16	2¼	3.163	5.94
TH-106	1½	5/8	1½	2¼	3.165	3.60
TH-14	1¼	¾	1¾	3	3.219	3.284

+ preferred core sizes: These cores should be used wherever possible in designing new transformers. They are subject to maximum discount regardless of quantity ordered. See selling policy 46-700.

pg 27

catalog number	dimensions in inches				relative power handlg capacity	weight: pounds
	strip width D	build up E	win-dow width F	win-dow length G		

**4 mil series TH**

TH-121	1 3/8	3/4	1 1/4	2 1/2	3.23	4.09
+TH-2	1 1/2	1	1	2 1/4	3.375	5.90
TH-64	1 1/2	3/4	1 1/4	2 1/2	3.515	4.57
TH-72	1 1/8	1	1 1/4	2 1/2	3.515	4.94
TH-119	1 5/8	1	1	2 1/4	3.66	6.30
+TH-79	1 3/4	3/4	1 1/4	2 1/4	3.692	5.34
TH-45	1 1/8	1 1/8	1 1/2	2	3.798	5.625
+TH-36	1 1/4	1	1 1/4	2 1/2	3.907	4.39
TH-73	1 1/4	3/4	1 1/8	4 1/16	4.285	4.81
TH-658	1 3/4	7/8	1	3	4.59	3.00
TH-654	1 3/4	1	1 1/2	1 3/4	4.60	6.65
TH-657	1 3/4	1 1/8	1	2 3/8	4.68	8.20
TH-103	1 1/2	1	1 1/4	2 1/2	4.687	6.37
TH-111	2	3/4	1 1/4	2 1/2	4.687	5.905
TH-113	1 5/8	1	1	3	4.875	7.094
TH-104	1 3/4	1	1 1/4	2 1/2	5.47	7.44
TH-57	1 1/4	1 1/16	1 3/8	3	5.478	6.66
TH-62	1	1	1 5/8	3 3/8	5.484	5.42
+TH-68	2	1	1	3	6.00	9.02
TH-100	1 1/2	1	1 3/8	3	6.189	7.11
TH-1	1 1/4	1	2 1/4	2 1/4	6.329	6.87
TH-8	1 1/4	7/8	1	6 1/8	6.70	7.295
TH-668	1 3/4	1	1 1/8	3 1/2	6.89	9.00
TH-118	1 3/4	1	1 3/8	3	7.218	8.30
TH-23	1 1/4	5/8	2	4 1 1/16	7.322	5.045
TH-108	1 7/8	1	1 9/16	2 1/2	7.322	8.29
TH-21	1 1/4	1 1/16	2	4 1 1/16	8.053	4.90
TH-663	1 1/2	1	1 1/2	4	9.00	8.41
TH-76	1 3/8	1 3/8	1 5/8	3	9.219	12.69
TH-134	1 3/8	1	1 3/8	5 5/16	10.04	8.88
TH-650	1 5/8	3/4	1 1/2	5 1/2	10.07	7.91
TH-22	1 1/4	7/8	2	4 1 1/16	10.257	7.05
TH-24	1 1/2	3/4	2	4 1 1/16	10.548	7.24
TH-86	2	1	1 3/8	3 3/8	10.656	10.78
TH-3	2	1 3/8	1 3/8	3	11.343	14.685
TH-54	2	1	2	3	12.00	11.57
+TH-75	1 5/8	1	1 1/2	5 1/16	12.341	10.73
TH-38	2	1 1/2	1 3/8	3	12.375	16.71
TH-63	2	1	1 5/8	4 3/16	13.611	12.00
TH-50	1 1/2	1	2	4 1 1/16	14.064	10.12
TH-137	3	1	1 5/8	3 3/8	16.47	15.80
TH-37	2 1/4	1 5/8	1 3/8	3 1/2	17.594	22.20
TH-147	1 3/4	1 3/8	1 3/8	4 3/8	18.38	21.50
TH-122	3	1	1 5/8	4 1/8	20.13	44.40
TH-114	3	1 1/8	1 5/8	4 3/16	22.966	23.15

+ preferred core sizes: These cores should be used wherever possible in designing new transformers. They are subject to maximum discount regardless of quantity ordered. See selling policy 46-700.

pg 28

catalog number	dimensions in inches				relative power handling capacity	weight: pounds
	strip width	build up	win-dow width	win-dow length		
	D	E	F	G		
<b>4 mil series TZ</b>						
TZ-14	3/8	1/4	7/16	1	.041	.14
TZ-25	1/2	1/4	7/16	1 1/8	.061	.198
TZ-17	1/2	3/8	7/16	1	.082	.309
TZ-26	3/4	1/4	7/16	1	.082	.27
TZ-36	3/4	1/4	1/2	1 9/16	.146	.361
TZ-35	3/4	5/16	1/2	1 9/16	.184	.468
TZ-11	3/4	3/8	1/2	1 9/16	.22	.675
TZ-21	1	1/2	1/2	1 9/16	.39	1.11
TZ-28	3/4	1/2	1 1/16	1 5/8	.419	.923
+TZ-20	3/4	3/8	3/4	2	.422	.768
TZ-23	1 1/8	1/2	1/2	1 9/16	.44	1.25
TZ-13	5/8	1/2	3/4	2	.47	.905
TZ-9	1	1/2	5/8	1 9/16	.488	1.214
TZ-18	1	1/2	1 1/16	1 5/8	.559	1.27
TZ-34	1	3/8	3/4	2	.562	.994
TZ-22	1/4	3/4	1	3	.564	3.81
TZ-27	1	1/2	1 1/16	2 1/16	.709	1.418
+TZ-12	1	1/2	3/4	2	.75	1.45
TZ-42	1	3/4	1 1/16	1 5/8	.838	2.076
TZ-15	1	1/2	7/8	2 1/4	.985	1.535
TZ-5	1 1/4	5/8	7/8	1 13/16	1.237	2.37
TZ-30	1	3/4	1	1 3/4	1.312	2.38
TZ-29	1	1/2	1	3	1.50	1.877
TZ-40	1 1/4	3/4	1	1 3/4	1.641	2.972
TZ-16	1	3/4	1	2 1/4	1.687	2.774
TZ-6	1 1/4	3/4	7/8	2 1/4	1.847	2.95
TZ-33	1	5/8	1	3	1.875	2.442
TZ-8	1	3/4	1	3	2.25	3.14
TZ-44	1 1/2	2 9/32	3/4	2 1/4	2.292	4.683
TZ-32	1 1/4	5/8	1	3	2.343	3.053
TZ-19	1	3/4	1 1/4	2 1/2	2.345	3.05
TZ-38	1 3/8	1 3/16	1	2 1/4	2.515	3.85
TZ-10	1	3/4	1	3 1/2	2.625	3.32
TZ-49	3/4	5/8	2	3	2.808	2.29
TZ-39	1 1/2	2 9/32	1	2 1/4	3.057	5.019
TZ-3	1 1/8	1	1 7/16	2	3.234	4.69
TZ-7	1 1/2	1	1	2 1/4	3.375	5.90
TZ-2	1 1/4	1	1 7/16	2	3.592	5.13
TZ-37	1 5/8	1 1/8	3/4	3	4.113	7.807
TZ-45	1 5/8	1	7/8	3	4.266	6.893
TZ-31	1 1/4	3/4	1 1/8	4 1/16	4.285	4.664
TZ-4	1 1/2	1	1 1/4	2 1/2	4.687	6.36
TZ-43	1 5/8	1	1	3	4.875	7.094
TZ-41	1 3/8	1	1 1/4	3	5.157	6.344
TZ-1	1 1/2	1	1 1/2	4	9.00	9.115
TZ-47	1 5/8	1	1 1/2	5 1/16	12.341	10.40
TZ-48	1 5/8	1 1/4	1 1/2	5 1/16	15.423	13.613

+ preferred core sizes: These cores should be used wherever possible in designing new transformers. They are subject to maximum discount regardless of quantity ordered. See selling policy 46-700.

ring type cores

core size	dimensions: inches				gross volume: cubic inches+	relative power handling capacity
	strip width: D	build up: E	inside dia.: F	outside dia.: A		
202	1/4	1/8	1/2	3/4	.061	.006
206	1/4	1/8	9/16	13/16	.067	.008
212	1/4	1/8	5/8	7/8	.073	.009
207	1/4	3/16	9/16	15/16	.111	.012
203	1/4	1/4	1/2	1	.148	.013
208	1/4	7/32	9/16	1	.135	.013
210	1/4	1/4	9/16	1 1/16	.161	.016
213	1/4	1/4	5/8	1 1/8	.173	.02
217	1/4	3/16	3/4	1 1/8	.139	.02
211	5/8	1/4	9/16	1 1/16	.24	.023
234	1/4	1/8	1	1 1/4	.11	.024
219	1/4	1/4	3/4	1 1/4	.198	.027
204	5/8	1/4	1/2	1	.368	.031
218	5/8	3/16	3/4	1 1/8	.209	.031
209	5/8	7/32	9/16	1	.336	.034
223	1/4	5/16	3/4	1 3/8	.26	.035
237	1/4	3/16	1	1 3/8	.175	.037
220	3/8	1/4	3/4	1 1/4	.295	.042
205	1/2	7/16	1/2	1 3/8	.645	.043
240	1/4	1/4	1	1 1/2	.247	.049
221	1/2	1/4	3/4	1 1/4	.393	.055
238	3/8	3/16	1	1 3/8	.265	.056
512	1/4	1/4	1 1/8	1 3/8	.272	.063
259	1/4	1/4	1 3/16	1 11/16	.285	.07
225	3/8	7/16	3/4	1 3/8	.612	.072
239	1/2	3/16	1	1 3/8	.351	.074
241	3/8	1/4	1	1 1/2	.369	.074
233	1/2	7/32	15/16	1 3/8	.40	.076
214	1/2	1/2	5/8	1 3/8	.884	.077
236	5/8	5/32	1	1 5/16	.356	.077
261	1/4	1/4	1 1/4	1 3/4	.297	.077
224	5/8	5/16	3/4	1 3/8	.651	.086
230	3/8	9/16	3/4	1 7/8	.87	.093
256	3/8	1/4	1 1/8	1 3/8	.406	.093
281	1/4	1/4	1 3/8	1 7/8	.322	.093
215	5/8	1/2	5/8	1 3/8	1.11	.096
263	1/4	5/16	1 1/4	1 7/8	.383	.096
222	7/8	1/4	3/4	1 1/4	.688	.097
226	1/2	7/16	3/4	1 3/8	.817	.097
309	1/4	3/16	1 3/8	2	.268	.097
242	1/2	1/4	1	1 1/2	.491	.098
235	1 1/8	1/8	1	1 1/4	.498	.111
244	3/8	3/8	1	1 3/4	.609	.111
292	1/4	1/4	1 1/2	2	.346	.112
216	3/4	1/2	5/8	1 3/8	1.32	.115
227	5/8	7/16	3/4	1 3/8	1.02	.121
243	5/8	1/4	1	1 1/2	.613	.123
395	1/4	1/8	2 3/8	2 5/8	.243	.137
289	3/8	1/4	1 7/16	1 15/16	.498	.152
262	1/2	1/4	1 1/4	1 3/4	.589	.153

+ Nominal core weight in pounds is obtained by multiplying the gross volume by the following factors: 12 mil—.262, 4 mil—.248, 2 mil—.246, 1 mil—.229.

appendix b—core listing K-26

ring type cores

core size	dimensions: inches				gross volume: cubic inches <sup>+</sup>	relative power handling capacity
	strip width: D	build up: E	inside dia.: F	outside dia.: A		
258	1/2	5/16	1 1/8	1 3/4	.704	.155
385	1/4	5/32	2 1/4	2 9/16	.295	.155
295	1/4	3/8	1 1/2	2 1/4	.554	.167
265	3/8	3/8	1 1/4	2	.72	.173
245	5/8	3/8	1	1 3/4	1.01	.164
249	1/2	1 5/32	1	1 11/16	1.09	.185
231	5/8	1 9/32	1 3/16	2	1.64	.192
228	1	7/16	3/4	1 5/8	1.63	.194
310	1/2	3/16	1 5/8	2	.535	.195
250	1/2	1/2	1	2	1.18	.196
506	1	1 1/32	7/8	1 9/16	1.31	.207
284	3/8	3/8	1 3/8	2 1/8	.775	.21
246	3/4	3/8	1	1 3/4	1.21	.221
291	1	1/8	1 1/2	1 3/4	.638	.221
293	1/2	1/4	1 1/2	2	.687	.221
322	1/4	3/8	1 3/4	2 1/2	.628	.226
330	3/8	7/32	1 7/8	2 5/16	.539	.226
266	1/2	3/8	1 1/4	2	.96	.231
232	3/4	1 9/32	1 3/16	2	1.97	.231
283	1/2	5/16	1 3/8	2	.827	.232
379	3/8	3/16	2 1/16	2 7/16	.502	.237
264	5/8	5/16	1 1/4	1 7/8	.957	.24
306	1/2	1/4	1 9/16	2 1/16	.712	.24
523	1 1/4	1/4	1	1 1/2	1.23	.246
296	3/8	3/8	1 1/2	2 1/4	.831	.249
247	7/8	3/8	1	1 3/4	1.42	.258
248	3/4	7/16	1	1 7/8	1.49	.258
308	1	1/8	1 5/8	1 7/8	.687	.259
311	1/2	1/4	1 3/8	2 1/8	.736	.259
267	5/8	3/8	1 1/4	2	1.19	.287
255	1 1/4	1 5/64	1 1/8	1 1 9/32	1.25	.291
279	5/8	1 1/32	1 5/16	2	1.12	.291
312	3/8	3/8	1 5/8	2 3/8	.886	.292
268	1/2	1/2	1 1/4	2 1/4	1.37	.307
257	1 1/4	1/4	1 1/8	1 5/8	1.35	.311
229	1 5/8	7/16	3/4	1 3/8	2.65	.315
331	1/2	1 5/64	1 7/8	2 1 1/32	.775	.323
260	1 1/4	7/32	1 1/4	1 1 1/16	1.27	.336
324	3/8	3/8	1 3/4	2 1/2	.941	.339
294	5/8	5/16	1 1/2	2 1/8	1.11	.345
328	1/2	1/4	1 7/8	2 3/8	.835	.346
332	1/2	1/4	1 7/8	2 3/8	.835	.346
426	3/8	3/16	2 9/16	2 1 5/16	.613	.366
353	1/4	1 5/32	2	2 1 5/16	.908	.368
341	1/2	1 7/64	1 2 9/32	2 7/16	.908	.379
297	1/2	7/16	1 1/2	2 3/8	1.33	.387
251	1	1/2	1	2	2.36	.393
344	1/2	1/4	2	2 1/2	.884	.393
282	1	9/32	1 3/8	1 1 5/16	1.46	.417
252	3/4	3/4	1	2 1/2	3.10	.442

<sup>+</sup> Nominal core weight in pounds is obtained by multiplying the gross volume by the following factors: 12 mil—.262, 4 mil—.248, 2 mil—.246, 1 mil—.229.

## ring type cores

core size	dimensions: inches				gross volume: cubic inches <sup>+</sup>	relative power handling capacity
	strip width: D	build up: E	inside dia.: F	outside dia.: A		
299	1/2	1/2	1 1/2	2 1/2	1.57	.442
350	3/8	3/8	2	2 3/4	1.05	.443
307	3/8	3/8	1 9/16	2 5/16	1.42	.448
334	3/8	7/16	1 7/8	2 3/4	1.19	.453
329	7/8	3/16	1 7/8	2 1/4	1.07	.456
269	3/4	1/2	1 1/4	2 1/4	2.06	.46
403	1	3/32	2 1/2	2 1 1/16	.766	.462
404	3/8	1/4	2 1/2	3	.812	.462
298	5/8	7/16	1 1/2	2 3/8	1.67	.485
319	1/4	1 5/16	1 5/8	3 1/2	1.89	.488
300	5/8	1/2	1 1/2	2 1/2	1.97	.553
354	3/8	1 5/32	2	2 1 5/16	1.36	.553
338	1/4	1 3/16	1 7/8	3 1/2	1.71	.561
343	1	3/16	2	2 3/8	1.29	.591
253	7/8	7/8	1	2 3/4	4.51	.602
405	1/2	1/4	2 1/2	3	1.08	.613
270	1	1/2	1 1/4	2 1/4	2.75	.614
285	1	7/16	1 3/8	2 1/4	2.49	.65
301	3/4	1/2	1 1/2	2 1/2	2.36	.663
313	7/8	3/8	1 5/8	2 5/8	2.06	.68
345	7/8	1/4	2	2 1/2	1.55	.688
335	1/2	1/2	1 7/8	2 7/8	1.86	.69
317	1/2	1 1/16	1 5/8	3	2.50	.714
320	3/8	1 5/16	1 5/8	3 1/2	2.83	.73
355	1/2	1 5/32	2	2 1 5/16	1.82	.738
287	1	1/2	1 3/8	2 3/8	2.95	.743
323	1 1/4	1/4	1 3/4	2 1/4	1.97	.753
406	5/8	1/4	2 1/2	3	1.35	.766
336	1/2	9/16	1 7/8	3	2.15	.776
254	1	1	1	1	6.28	.785
346	1	1/4	2	2 1/2	1.77	.785
356	1/2	1/2	2	3	1.96	.785
370	1/4	1	2	4	2.36	.785
351	5/8	1 3/32	2	2 1 3/16	1.92	.798
384	1 5/8	1/8	2 1/4	2 1/2	1.51	.807
302	1	1/2	1 1/2	2 1/2	3.14	.884
453	1/4	1/2	3	4	1.38	.884
325	7/8	7/16	1 3/4	2 5/8	2.63	.921
408	5/8	5/16	2 1/2	3 1/8	1.72	.957
321	1/2	1 5/16	1 5/8	3 1/2	3.78	.973
286	1 1/2	7/16	1 3/8	2 1/4	3.74	.975
520	2	5/32	2	2 5/16	2.11	.98
348	1	5/16	2	2 5/8	2.27	.98
357	5/8	1/2	2	3	2.46	.983
333	1 1/2	1/4	1 7/8	2 3/8	2.50	1.04
276	1 1/4	2 3/32	1 1/4	2 1 1/16	5.56	1.10
303	1	5/8	1 1/2	2 3/4	4.17	1.10
349	1 1/8	5/16	2	2 5/8	2.55	1.10
342	3/8	1 1/32	1 1 5/16	4	3.61	1.14
278	1 1/4	3/4	1 1/4	2 3/4	5.89	1.15

<sup>+</sup> Nominal core weight in pounds is obtained by multiplying the gross volume by the following factors:  
12 mil—.262, 4 mil—.248, 2 mil—.246, 1 mil—.229.

ring type cores

core size	dimensions: inches				gross volume: cubic inches+	relative power handling capacity
	strip width: D	build up: E	inside dia.: F	outside dia.: A		
358	3/4	1/2	2	3	2.95	1.18
371	3/8	1	2	4	3.53	1.18
430	7/8	1/4	2 5/8	3 1/8	1.98	1.19
327	1	1/2	1 3/4	2 3/4	3.53	1.20
362	5/8	5/8	2	3 1/4	3.22	1.23
407	1	1/4	2 1/2	3	2.16	1.23
410	1/2	1/2	2 1/2	3 1/2	2.36	1.23
339	9/16	1 3/16	1 7/8	3 1/2	3.85	1.26
363	5/8	4 1/64	2	3 9/32	3.33	1.26
433	5/8	3/8	2 5/8	3 3/8	2.21	1.27
352	1	1 3/32	2	2 13/16	3.07	1.28
428	5/8	1 3/32	2 9/16	3 3/8	2.37	1.31
304	1	3/4	1 1/2	3	5.30	1.33
452	1/2	3/8	3	3 3/4	1.99	1.33
364	5/8	1 1/16	2	3 3/8	3.63	1.35
434	1/2	1/2	2 5/8	3 5/8	2.46	1.35
505	1	1/2	1 7/8	2 7/8	3.73	1.38
288	1 1/4	3/4	1 3/8	2 7/8	6.26	1.39
450	5/8	1 1/32	2 7/8	3 9/16	2.17	1.40
382	3/4	1/2	2 9/16	3 9/16	3.17	1.41
314	1 7/8	3/8	1 5/8	2 3/8	4.42	1.46
439	2	1/8	2 3/4	3	2.26	1.49
315	2	3/8	1 5/8	2 5/8	4.71	1.56
347	2	1/4	2	2 1/2	3.54	1.57
359	1	1/2	2	3	3.93	1.57
372	1/2	1	2	4	4.71	1.57
425	2 1/2	1/8	2 9/16	2 13/16	2.64	1.61
402	3/4	1/2	2 13/32	3 13/32	3.42	1.71
409	1	2 9/64	2 1/2	3 7/32	3.23	1.76
290	2 1/4	1/2	1 7/16	2 7/16	6.85	1.83
411	3/4	1/2	2 1/2	3 1/2	3.53	1.84
275	2 1/4	1 1/16	1 1/4	2 5/8	9.42	1.90
445	2	5/32	2 13/16	3 1/8	2.91	1.94
360	1 1/4	1/2	2	3	4.91	1.96
386	2	1/4	2 1/4	2 3/4	3.93	1.99
429	5/8	5/8	2 19/32	3 27/32	3.95	2.07
280	2 1/2	5/8	1 9/16	2 9/16	9.51	2.11
412	7/8	1/2	2 1/2	3 1/2	4.13	2.15
378	1/2	1 3/8	2	4 3/4	7.30	2.16
396	1	1/2	2 3/8	3 3/8	4.52	2.22
447	5/8	1 9/32	2 13/16	4	3.97	2.30
468	1 1/4	1/4	3 1/16	3 9/16	3.26	2.31
316	2	9/16	1 5/8	2 3/4	7.72	2.33
365	1	3/4	2	3 1/2	6.48	2.36
373	3/4	1	2	4	7.07	2.36
431	1 3/4	1/4	2 5/8	3 1/8	3.96	2.37
326	2	1/2	1 3/4	2 3/4	7.07	2.41
474	1	1/4	3 1/2	4	2.95	2.41
381	3/4	5 9/64	2 1/8	3 1 1/32	6.62	2.45
413	1	1/2	2 1/2	3 1/2	4.71	2.45

+ Nominal core weight in pounds is obtained by multiplying the gross volume by the following factors: 12 mil—.262, 4 mil—.248, 2 mil—.246, 1 mil—.229.



ring type cores

core size	dimensions: inches				gross volume: cubic inches+	relative power handling capacity
	strip width: D	build up: E	inside dia.: F	outside dia.: A		
519	1 $\frac{3}{8}$	$\frac{3}{4}$	1 $\frac{3}{4}$	3 $\frac{1}{4}$	8.10	2.48
387	1	$\frac{5}{8}$	2 $\frac{1}{4}$	3 $\frac{1}{2}$	5.65	2.49
380	2	$\frac{3}{8}$	2 $\frac{1}{8}$	2 $\frac{7}{8}$	5.89	2.66
432	2	$\frac{1}{4}$	2 $\frac{5}{8}$	3 $\frac{1}{8}$	4.52	2.71
374	$\frac{7}{8}$	1	2	4	8.25	2.75
486	$\frac{7}{8}$	$\frac{1}{4}$	4	4 $\frac{1}{2}$	2.92	2.75
440	1	$\frac{1}{2}$	2 $\frac{3}{4}$	3 $\frac{3}{4}$	5.10	2.97
435	1 $\frac{1}{8}$	$\frac{1}{2}$	2 $\frac{5}{8}$	3 $\frac{5}{8}$	5.53	3.05
500	$\frac{1}{2}$	$\frac{5}{16}$	5	5 $\frac{5}{8}$	2.60	3.06
415	1	$\frac{5}{8}$	2 $\frac{1}{2}$	3 $\frac{3}{4}$	6.14	3.07
361	2	$\frac{1}{2}$	2	3	7.85	3.14
375	1	1	2	4	9.43	3.14
398	1 $\frac{1}{8}$	2 $\frac{1}{32}$	2 $\frac{3}{8}$	3 $\frac{11}{16}$	7.03	3.27
318	1 $\frac{3}{4}$	5 $\frac{9}{64}$	1 $\frac{5}{8}$	3 $\frac{15}{32}$	12.90	3.35
366	1 $\frac{1}{2}$	$\frac{3}{4}$	2	3 $\frac{1}{2}$	9.72	3.53
454	1	$\frac{1}{2}$	3	4	5.50	3.53
418	1	$\frac{3}{4}$	2 $\frac{1}{2}$	4	7.66	3.68
424	$\frac{1}{2}$	1 $\frac{1}{2}$	2 $\frac{1}{2}$	5 $\frac{1}{2}$	9.43	3.68
469	2	$\frac{1}{4}$	3 $\frac{1}{16}$	3 $\frac{9}{16}$	5.20	3.68
448	1	1 $\frac{9}{32}$	2 $\frac{13}{16}$	4	6.36	3.69
388	1 $\frac{1}{2}$	$\frac{5}{8}$	2 $\frac{1}{4}$	3 $\frac{1}{2}$	8.47	3.73
478	$\frac{5}{8}$	$\frac{5}{8}$	3 $\frac{1}{2}$	4 $\frac{3}{4}$	5.07	3.76
416	1 $\frac{1}{4}$	$\frac{5}{8}$	2 $\frac{1}{2}$	3 $\frac{3}{4}$	7.67	3.83
305	2	1 $\frac{1}{8}$	1 $\frac{1}{2}$	3 $\frac{3}{4}$	18.60	3.98
518	1 $\frac{1}{2}$	1 $\frac{1}{2}$	1 $\frac{1}{2}$	4 $\frac{1}{2}$	21.20	3.98
421	1	$\frac{7}{8}$	2 $\frac{1}{2}$	4 $\frac{1}{4}$	9.28	4.30
376	1 $\frac{3}{8}$	1	2	4	13.00	4.32
391	1 $\frac{1}{8}$	1	2 $\frac{1}{4}$	4 $\frac{1}{4}$	11.50	4.47
417	1 $\frac{1}{2}$	$\frac{5}{8}$	2 $\frac{1}{2}$	3 $\frac{3}{4}$	9.21	4.61
367	2	$\frac{3}{4}$	2	3 $\frac{1}{2}$	12.90	4.71
377	1 $\frac{1}{2}$	1	2	4	14.10	4.71
401	1	1 $\frac{1}{16}$	2 $\frac{3}{8}$	4 $\frac{1}{2}$	11.50	4.71
337	2 $\frac{1}{2}$	1 $\frac{1}{16}$	1 $\frac{7}{8}$	3 $\frac{1}{4}$	13.80	4.75
476	1	$\frac{1}{2}$	3 $\frac{1}{2}$	4 $\frac{1}{2}$	6.28	4.81
427	2 $\frac{1}{2}$	$\frac{3}{8}$	2 $\frac{9}{16}$	3 $\frac{5}{16}$	8.66	4.84
515	1 $\frac{3}{8}$	$\frac{1}{2}$	3	4	7.56	4.86
389	2	$\frac{5}{8}$	2 $\frac{1}{4}$	3 $\frac{1}{2}$	11.30	4.97
436	1 $\frac{1}{4}$	$\frac{3}{4}$	2 $\frac{5}{8}$	4 $\frac{1}{8}$	9.95	5.08
446	1 $\frac{7}{8}$	$\frac{7}{16}$	2 $\frac{13}{16}$	3 $\frac{1}{16}$	8.38	5.10
390	1 $\frac{1}{2}$	$\frac{7}{8}$	2 $\frac{1}{4}$	4	12.90	5.22
368	2	2 $\frac{7}{32}$	2	3 $\frac{11}{16}$	15.10	5.30
457	1	$\frac{3}{4}$	3	4 $\frac{1}{2}$	8.84	5.30
465	$\frac{1}{2}$	1 $\frac{1}{2}$	3	6	10.60	5.301
477	1 $\frac{1}{8}$	$\frac{1}{2}$	3 $\frac{1}{2}$	4 $\frac{1}{2}$	7.08	5.41
479	$\frac{3}{4}$	$\frac{3}{4}$	3 $\frac{1}{2}$	5	7.52	5.42
414	2 $\frac{1}{4}$	$\frac{1}{2}$	2 $\frac{1}{2}$	3 $\frac{1}{2}$	10.60	5.52
419	1 $\frac{1}{2}$	$\frac{3}{4}$	2 $\frac{1}{2}$	4	11.50	5.52
400	1 $\frac{1}{4}$	1	2 $\frac{3}{8}$	4 $\frac{3}{8}$	13.20	5.54
397	2 $\frac{1}{4}$	$\frac{9}{16}$	2 $\frac{3}{8}$	3 $\frac{1}{2}$	11.70	5.61
487	1	$\frac{1}{2}$	4	5	7.07	6.28

+ Nominal core weight in pounds is obtained by multiplying the gross volume by the following factors: 12 mil—.262, 4 mil—.248, 2 mil—.246, 1 mil—.229.

appendix b—core listing K-30

ring type cores

core size	dimensions: inches				gross volume: cubic inches+	relative power handling capacity
	strip width: D	build up: E	inside dia.: F	outside dia.: A		
451	1/2	1 5/16	2 7/8	6 3/4	14.60	6.29
383	2	2 7/32	2 3/16	3 7/8	16.10	6.35
340	2 1/2	1 9/16	1 7/8	3 3/4	20.70	6.48
466	1/2	1 27/32	3	6 1 1/16	14.00	6.52
399	2 1/4	2 1/32	2 3/8	3 1 1/16	14.10	6.54
392	1 1/2	1 1/8	2 1/4	4 1/2	17.90	6.71
393	1	1 1 1/16	2 1/4	5 9/8	20.90	6.71
394	2	2 7/32	2 9/32	3 3 1/32	16.90	6.90
422	1 1/8	1 1/4	2 1/2	5	16.60	6.90
455	2	1/2	3	4	11.00	7.07
459	1	1	3	5	12.60	7.07
480	1	3/4	3 1/2	5	10.00	7.22
420	2	3/4	2 1/2	4	15.30	7.36
475	2 1/2	5/16	3 1/2	4 1/8	9.34	7.50
369	2 1 3/16	1 9/16	2	3 7/8	24.40	8.29
456	1 3/4	1 1/16	3	4 3/8	13.90	8.51
470	1 3/4	1 3/16	3 1/8	4 3/4	13.80	8.57
458	1 1/2	7/8	3	4 3/4	16.00	9.28
510	1	1	3 1/2	5 1/2	14.10	9.62
461	1 1/4	1 1/8	3	5 1/4	18.20	9.94
491	1	1 3/16	4	5 9/8	12.30	10.20
444	1	1 3/4	2 3/4	6 1/4	24.70	10.40
509	2	3/4	3	4 1/2	17.70	10.60
460	1 1/2	1	3	5	18.90	10.60
437	2	1	2 5/8	4 9/8	22.80	10.80
463	1 1/4	1 1/4	3	5 1/2	20.90	11.10
449	1 3/8	1 5/16	2 1 3/16	5 7/16	23.40	11.20
488	1 1/4	3/4	4	5 1/2	14.00	11.80
441	2	1	2 3/4	4 3/4	23.60	11.90
423	2	1 1/4	2 1/2	5	29.50	12.30
471	2	3/4	3 1/4	4 3/4	18.80	12.50
462	1 1/2	1 3/16	3	5 3/8	23.40	12.60
492	1	1	4	6	15.70	12.60
489	1 1/2	3/4	4	5 1/2	16.80	14.10
438	2 1 3/16	1 1/16	2 9/8	4 3/4	34.60	16.20
494	2 3/4	1/2	3 7/8	4 7/8	18.90	16.20
442	2	1 3/8	2 3/4	5 1/2	35.60	16.30
490	1 3/4	3/4	4	5 1/2	19.60	16.50
508	2	7/8	3 1/2	5 1/4	24.10	16.80
464	2	1 1/4	3	5 1/2	33.40	17.70
443	2 1/4	1 3/8	2 3/4	5 1/2	40.10	18.30
472	2 1/4	1	3 1/4	5 1/4	30.00	18.70
493	1 1/2	1	4	6	23.60	18.90
495	1 1/4	1 1/4	4	6 1/2	25.80	19.60
473	2 1/2	1	3 1/4	5 1/4	33.40	20.70
498	1 3/8	1 1/16	4 5/16	6 7/16	24.60	21.30
483	1 7/8	1 1/32	3 3/4	5 1 3/16	29.00	21.40
467	1 3/4	1 7/8	3	6 3/4	50.20	23.20
481	2 1/2	1	3 1/2	5 1/2	35.30	24.10
502	1	1	5 9/8	7 5/8	20.80	24.80

+ Nominal core weight in pounds is obtained by multiplying the gross volume by the following factors: 12 mil—.262, 4 mil—.248, 2 mil—.246, 1 mil—.229.

## ring type cores

core size	dimensions: inches				gross volume: cubic inches <sup>†</sup>	relative power handling capacity
	strip width: D	build up: E	inside dia.: F	outside dia.: A		
494	2	1	4	6	31.40	25.10
507	2	1 $\frac{1}{8}$	4 $\frac{1}{4}$	6 $\frac{1}{2}$	37.90	31.90
496	2	1 $\frac{1}{2}$	4	7	51.80	37.70
497	2 $\frac{1}{2}$	1 $\frac{1}{2}$	4	7	64.80	47.10
499	1 $\frac{3}{8}$	2 $\frac{1}{8}$	4 $\frac{7}{8}$	9 $\frac{1}{8}$	64.30	54.50
485	4	1 $\frac{3}{8}$	3 $\frac{7}{8}$	6 $\frac{5}{8}$	90.70	64.90
501	2	1 $\frac{3}{4}$	5	8 $\frac{1}{2}$	74.20	68.70
503	2 $\frac{1}{4}$	1 $\frac{5}{16}$	5 $\frac{5}{8}$	8 $\frac{1}{4}$	64.30	73.30
482	3	3	3 $\frac{1}{2}$	9 $\frac{1}{2}$	184.00	86.60

<sup>†</sup> Nominal core weight in pounds is obtained by multiplying the gross volume by the following factors:  
 12 mil—.262, 4 mil—.248, 2 mil—.246, 1 mil—.229.

